

Cooper Boulevard Corridor Transportation Study

Prepared for:

GANDER



TOWN OF GANDER
100 ELIZABETH DRIVE
GANDER, NL
A1V 1G7

PROJECT NO. 1901214

Prepared by:



Adriana Terán, P. Eng.
Traffic Engineer
Crandall, a Division of Englobe

Approved by:



Peter Allaby, P. Eng., M.A.Sc.
Senior Transportation Engineer
Crandall, a Division of Englobe

Table of Contents

1	Introduction.....	1
1.1	BACKGROUND.....	1
1.2	STUDY TASKS.....	1
1.3	STUDY METHODOLOGY	3
2.0	Information Gathering.....	4
2.1	STREET AND INTERSECTION CHARACTERISTICS	4
2.2	TRAFFIC COUNTS	9
2.3	FUTURE TRAFFIC VOLUMES.....	9
3.0	Existing Travel Conditions	11
3.1	INTRODUCTION.....	11
3.2	COLLISION ANALYSIS.....	11
3.3	OPERATIONAL CONDITIONS	12
4.0	Future Travel Conditions Analysis	16
4.1	INTRODUCTION.....	16
4.2	10-YEAR HORIZON PERIOD TRAFFIC VOLUMES.....	16
4.3	COOPER BOULEVARD DEVELOPMENT ASSUMPTIONS.....	16
4.4	TRAFFIC GENERATION AND ASSIGNMENT	20
4.5	10-YEAR ESTABLISHED GEOMETRIC IMPROVEMENTS	20
4.6	10-YEAR OPERATIONAL CONDITIONS.....	22
5.0	Cooper Boulevard Corridor Concept Design	27
5.1	TRAFFIC SIGNAL WARRANT ANALYSIS.....	27
5.2	INTERSECTION CAPACITY IMPROVEMENTS.....	28
5.3	ROUNDBOUT ANALYSIS.....	29
5.4	PEDESTRIAN AND CYCLING FACILITIES	33
5.5	ACCESS REVIEW	35
5.6	CORRIDOR OPTIONS AND IMPLEMENTATION PLAN	35
5.7	IMPROVEMENT OPTIONS OPERATIONAL CONDITIONS	37
5.8	TRAFFIC SIGNAL VERSE ROUNDBOUT COMPARISON.....	41
5.9	PRELIMINARY CONSTRUCTION COST ESTIMATES	42
6.0	Conclusion	43

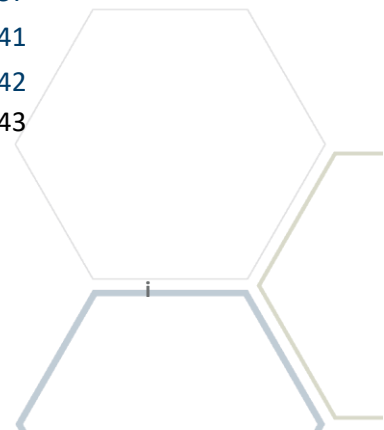

Tables

Table 1 – Intersection Level of Service Criteria	3
Table 2 – Existing AADT Volume by Corridor Segment.....	4
Table 3 – Existing 2020 LOS Results	13
Table 4 - 10-Year AADT Volume by Corridor Segment	16
Table 5 – Land Uses and Build-Out Estimates	19
Table 6 – 10-Year Trip Generation	19
Table 7 – Origin-Destination of Traffic Entering and Exiting the Network	20
Table 8 – Future 2030 LOS Results.....	24
Table 9 – Traffic Signal Warrant Analysis Results	27
Table 10 - Location of Pedestrian and Cycling Facilities along Cooper Boulevard.....	34
Table 11 - Improvement Options	36
Table 12 – Future Option 1 Improvement LOS Results to Improved Intersections.....	38
Table 13 - Memorial Drive at Cooper Boulevard VISSIM LOS Results	40
Table 14 - Roe Avenue at Cooper Boulevard Arcady LOS Results	40
Table 15 - Airport Boulevard at Cooper Boulevard Arcady LOS Results	41
Table 16 – Traffic Signal and Roundabout Comparison	41

Figures

Figure 1 – Study Area.....	2
Figure 2 – Existing 2020 Traffic Volumes	10
Figure 3 - Vehicle Collision Location along Cooper Boulevard.....	11
Figure 4 - Planned Development Along Cooper Boulevard	18
Figure 5 –Projected 2030 Traffic Volumes.....	21
Figure 6 – Conflict Point Comparison between Roundabouts and Traditional Intersections	29
Figure 7 - Memorial Drive at Cooper Boulevard Roundabout Concept	31
Figure 8 - Roe Avenue at Cooper Boulevard Roundabout Concept.....	32
Figure 9 - Airport Boulevard at Cooper Boulevard Roundabout Concept.....	33

Appendices

Appendix A	Traffic Counts
Appendix B	Synchro LOS Reports
Appendix C	Traffic Signal Warrant Analysis Worksheets
Appendix D	Couper Boulevard Concept Design Plan
Appendix E	Couper Boulevard Construction Cost Estimates

1 INTRODUCTION

1.1 BACKGROUND

The Town of Gander has experienced significant development growth along Cooper Boulevard in recent years and this growth is expected to continue. The development growth has resulted in increased traffic pressures along Cooper Boulevard and a more urbanized character with higher demand for pedestrian and cycling. In response to this growth, the Town of Gander has retained Crandall to complete a comprehensive corridor transportation study for Cooper Boulevard. The main objectives of this study were to determine functional requirements of Cooper Boulevard in the long term (10-year) planning period and develop a corridor plan to serve all modes of transportation. The Study Area for this project includes Cooper Boulevard from Trans Canada Highway 1 to Magee Road as well as adjacent developable lands, as shown in **Figure 1**.

1.2 STUDY TASKS

The following activities were undertaken as part of this study:

- Existing information was collected and reviewed, which included traffic volumes and signal timings for intersections along Cooper Boulevard and past development concept plans for Cooper Boulevard;
- Crandall staff consulted with planning and engineering staff from the Town to formulate reasonable development projections regarding land use type, development location and area, and build-out rate for the Cooper Boulevard corridor and surrounding lands;
- Mapping data were assembled for the project corridor, including aerial photography, property mapping, wetland information, and topographic data;
- Available turning movement counts along the study corridor were collected and assembled for review by the Study Team. All remaining intersections with no recent data had turning movement counts performed by the Town;
- Existing traffic volumes within the Study Area were summarized and LOS analyses were completed for the AM and PM peak periods;
- Future development traffic for the 10-year horizon was estimated using a combination of ITE trip generation rates for the various development types that are anticipated. The development types and build-out rates were estimated based on information provided by the Town and the Airport Authority;
- Future traffic projections were created for the 10-year horizons by applying a 1% growth rate to the existing traffic volumes and adding future development traffic;
- LOS analyses were completed for the 10-year horizon periods;
- The functional requirements along Cooper Boulevard, including intersection configurations, street cross-sections, pedestrian and cycling facilities, crosswalks, and driveway locations, were determined for the 10-year horizons.
- Concept plans were created that illustrate the most feasible and practical options for the corridor; and
- The methodology, findings, and recommendations of the Study were documented in this report.
-

Figure 1 – Study Area

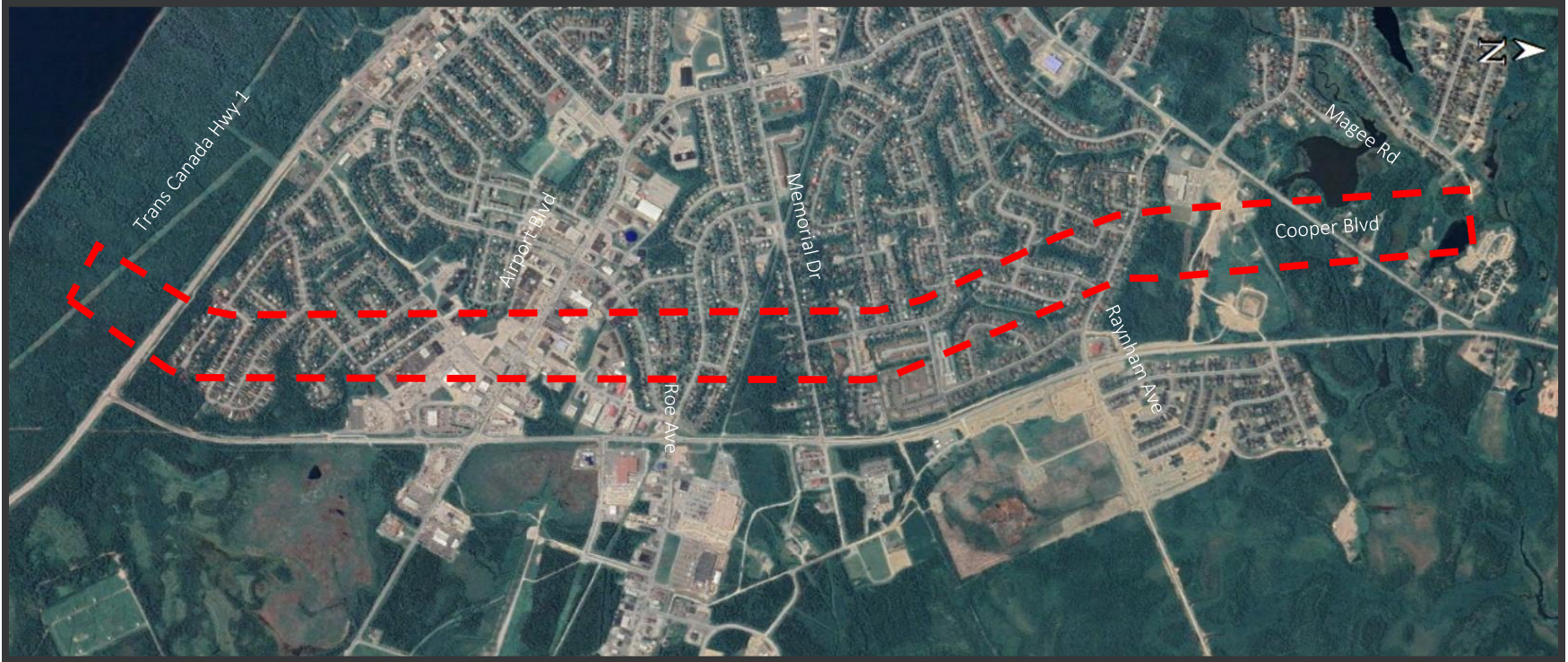

1.3 STUDY METHODOLOGY

Trip Generation

Future trip generation rates for the proposed development areas were estimated using existing trip generation rates and the TripGen 2014 software, which is based on the 10th Edition of the Institute of Transportation Engineer's (ITE) *Trip Generation Manual*.

Traffic Modelling

Traffic conditions for signalized and stop control intersections were modelled using Synchro 9, which is a traffic analysis software that uses the Highway Capacity Manual and Intersection Capacity Utilization procedures. Potential roundabout options were assessed using Junctions 9 software.

Intersection and roundabout performance were evaluated mainly in terms of the level of service (LOS), which is a common performance measurement of an intersection. The LOS is determined based on vehicle delay and is expressed on a scale of A through F, where LOS A represents very short delay (<10 seconds per vehicle) and LOS F represents very long delay (>50 seconds per vehicle at a stop controlled intersection and >80 seconds per vehicle at a signalized intersection). A LOS D is often considered acceptable in urban locations; however, some communities will accept a LOS E. The LOS criteria for signalized intersections and stop control intersections/roundabouts are shown in **Table 1**.

Table 1 – Intersection Level of Service Criteria

LOS	LOS Description	Control Delay (seconds per vehicle)	
		Signalized Intersections	Stop Controlled Intersections and Roundabouts
A	Very low delay; most vehicles do not stop (Excellent)	less than 10.0	less than 10.0
B	Higher delay; more vehicles stop (Very Good)	between 10.0 and 20.0	between 10.0 and 15.0
C	Higher level of congestion; number of vehicles stopping is significant, although many still pass through intersection without stopping (Good)	between 20.0 and 35.0	between 15.0 and 25.0
D	Congestion becomes noticeable; vehicles must sometimes wait through more than one red light; many vehicles stop (Satisfactory)	between 35.0 and 55.0	between 25.0 and 35.0
E	Vehicles must often wait through more than one red light; considered by many agencies to be the limit of acceptable delay	between 55.0 and 80.0	between 35.0 and 50.0
F	This level is considered to be unacceptable to most drivers; occurs when arrival flow rates exceed the capacity of the intersection (Unacceptable)	greater than 80.0	greater than 50.0

In addition to the LOS criteria described above, the volume to capacity (v/c) ratio, the 95th percentile queue length, and the average delay were reported for each turning movement.

2.0 INFORMATION GATHERING

2.1 STREET AND INTERSECTION CHARACTERISTICS

Cooper Boulevard is an arterial roadway within the Town and a provincial, collector highway (Route 330). Cooper Boulevard features a two-lane cross-section with auxiliary turning lanes at intersections. Access to Cooper Boulevard is limited to public street intersections and major development accesses. Generally, two-lane sections of the roadway have a 7.0m to 8.0m wide asphalt surface and gravel shoulders of 2.5-4.0m on either side. A sidewalk is present on the west side of Cooper Boulevard between Memorial Drive and Roe Avenue. An ATV trail also runs along the west side of Cooper Boulevard from Memorial Drive to 600m north of Raynham Avenue. The posted speed limit is 60 km/h along the corridor.

Cooper Boulevard serves many functions. It is a primary thoroughfare for movements within the Town, it connects the TCH to destinations north of Gander, it serves as a primary connection to the Gander International Airport, it provides access to adjacent commercial and residential areas and serves as a school bus route for the Gander High School.

The existing Annual Average Daily Traffic (AADT) volume along Cooper Boulevard ranges from approximately 3,600 vehicles north of Raynham Avenue to 10,900 vehicles from Memorial Drive to Roe Avenue. AADT volumes by corridor segment are listed in **Table 2**.

Table 2 – Existing AADT Volume by Corridor Segment

Corridor Segment	AADT
Magee Rd to Mitchell Street	3,300 veh/day
Mitchell Street to Raynham Ave	3,900 veh/day
Raynham Ave to Memorial Dr	8,500 veh/day
Memorial Dr to Roe Ave	10,900 veh/day
Roe Ave to Catalina Rd	10,800 veh/day
Catalina Dr to Airport Blvd	10,200 veh/day
Airport Blvd to Laurel Rd	7,300 veh/day
Laurel Rd to TCH	5,900 veh/day

There are currently two signalized intersections along Cooper Boulevard and seven stop-control intersections on Cooper Boulevard included as part of this study. The two signalized intersections operate under actuated control. Each stop-controlled intersection operates under stop-control on the minor approaches and free-flow on Cooper Boulevard with the exception of the TransCanada Highway 1 intersection which operates with the stop-control on Cooper Boulevard only, the minor approach. A list of the study intersections along with key characteristics is provided below:

Cooper Boulevard @ Magee Road (Stop Control)

This 3-leg intersection has stop control on the eastbound Magee Road approach. The northbound approach on Cooper Boulevard has a single through lane and a separate left turn lane with storage length of approximately 60m plus taper.



Cooper Boulevard @ Mitchell Street (Stop Control)

This 3-leg intersection has stop control on the westbound Mitchell Street approach. The southbound approach on Cooper Boulevard has a single thru lane and a separate left turn lane. The northbound approach has a single thru lane and separate right turn lane. Mitchell Street has separate right and left turning lanes. Channelized painted islands are provided for the northbound and westbound right turn lanes. A sidewalk runs along the south side of Mitchell Street.



Cooper Boulevard @ Raynham Avenue (Stop Control)

This 4-leg intersection is stop controlled with stop signs on the eastbound Raynham Avenue approach and westbound Briggs Street approach. The eastbound and westbound approaches feature a shared thru-left lane and separate right turn lane. The westbound right turn is channelized with a painted island. The northbound approach features an exclusive left turn lane a single thru lane and a separate right turn lane. The southbound approach features a separate left turn lane and shared thru-right lane. Sidewalk runs along the north side of Raynham Avenue and Briggs Street and a Rectangular Rapid Flashing Beacon (RRFB) pedestrian crossing is located on the north leg of Cooper Boulevard. Street lighting is provided at the crosswalk. A fire station is located in the northwest corner of the intersection.



Cooper Boulevard @ Memorial Drive (Stop Control)

This 4-leg intersection is stop controlled with stop signs on the eastbound and westbound Memorial Drive approaches. The southbound and northbound approaches feature an exclusive left turn lane with a shared thru / right turn lane. The eastbound and westbound approaches feature a single lane approach. The northbound, eastbound, and westbound approaches feature right turn channelization with painted islands. Stops signs are placed on the eastbound and westbound slip lanes.



Cooper Boulevard @ Roe Avenue (Signalized)

This 4-leg intersection operates under actuated traffic signal control. Advanced left turn phases are provided on all four approaches. The northbound and southbound approaches on Cooper Blvd have a single thru lane and separate left turn and right turn lanes. The right turn lanes were recently constructed in response to increasing traffic volumes and queuing. The westbound approach Roe Avenue approach has a thru lane, left turn lane and right turn lane while the eastbound approach has a left turn lane and shared thru-right lane. All approaches feature right turn channelization. Pedestrian crossings controlled with pedestrian signal heads are provided across all four approaches. The concrete channelized islands are small and positioned such that left turning truck movements at the intersection are difficult.



Cooper Boulevard @ Catalina Drive (Stop Control)

This 3-leg intersection has stop control on the westbound Catalina Road Approach. The southbound approach on Cooper Boulevard has a single thru lane and a separate left turn lane. The northbound approach has a single shared thru-right lane. Catalina Drive has separate right and left turning lanes. A sidewalk runs along the north side of Catalina Drive.

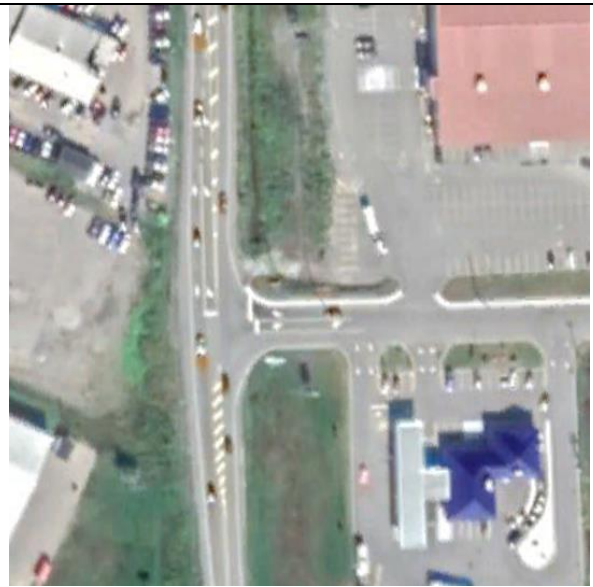

Cooper Boulevard @ Airport Boulevard (Signalized)

This 4-leg intersection operates under actuated traffic signal control. Advanced left turn phases are provided on all four approaches. There are pedestrian crossings controlled with pedestrian signal heads across all four approaches. Each approach features a shared thru / right turn lane as well as an exclusive left turn lane. Right turn channelization is provided on all approaches. The skewed intersection angle presents challenges for truck turning movements and presents safety concerns.



Cooper Boulevard @ Laurel Rd (Stop Control)

This 3-leg intersection has stop control on the eastbound Laurel Road approach. The northbound approach on Cooper Boulevard has a single through lane and a separate left turn lane. Channelized paint islands are provided for the eastbound and southbound right turn movements.



Cooper Boulevard @ TCH (Stop Control)

This 3-leg intersection is stop controlled with a stop sign on the Cooper Boulevard approach. The eastbound approach on the TCH features a separate left turn lane. The westbound direction has a right turn lane and as well as an acceleration lane for right turns entering from Cooper Boulevard. Large channelized painted islands are provided. The Cooper Boulevard approach has a single lane, but the size of the right turn island allows a few left turning vehicles to queue before blocking right turning vehicles.



2.2 TRAFFIC COUNTS

The Town of Gander completed AM, Noon, and PM peak hour traffic counts at the following Study Area intersections in December 2019:

- Cooper Boulevard/Magee Road (Tuesday, December 3, 2019);
- Cooper Boulevard/Mitchell Street (Tuesday, December 3, 2019);
- Cooper Boulevard/Roe Avenue (Wednesday, December 4, 2019);
- Cooper Boulevard/Catalina Drive (Tuesday, December 3, 2019);
- Cooper Boulevard/Airport Boulevard (Tuesday, December 3, 2019);
- Cooper Boulevard/Laurel Road (Wednesday, December 4, 2019); and
- Cooper Boulevard/TCH 1 (Wednesday, December 4, 2019).

In addition to the above counts the Town completed traffic counts at the following intersections in 2018 as part of a separate study:

- Cooper Boulevard/Raynham Avenue (Thursday, June 14, 2018); and
- Cooper Boulevard/Memorial Drive (Thursday, June 14, 2018).

The existing AM and PM peak hour traffic volumes at Study Area intersections are displayed in **Figure 2**. All traffic count sheets are provided in **Appendix A**.

2.3 FUTURE TRAFFIC VOLUMES

Horizon Year

The existing and a horizon year traffic conditions were assessed to determine the future functional requirements of Cooper Boulevard and to determine upgrade requirements. A 10-year horizon period was established to capture ongoing and planned development growth. This results in a horizon year of 2030. The future traffic volumes for the 10-year horizon period were estimated by adding a combination of background traffic growth and additional trips generated from planned developments such as the Gander Landing Development to the existing traffic volumes shown in **Figure 2**.

Background Growth

The Study Team estimated the background traffic volumes for the 10-year horizon periods by applying an annual traffic growth rate of 1.0% to the existing traffic volumes. This will account for increased traffic on Cooper Boulevard as a result of continued growth throughout the Town.

Future Development

Several major developments are planned along Cooper Boulevard. The Study Team used a combination of ITE trip generation rates and information gathered from previous traffic impact studies to estimate future trips that will be generated by all planned developments. These trips were added to the Cooper Boulevard network for each of the horizon periods. Details of the 10-year development assumptions are discussed in **Section 4.3** and future traffic projections are presented as well in **Figure 5**.

FIGURE 2 - 2020 EXISTING TRAFFIC VOLUMES

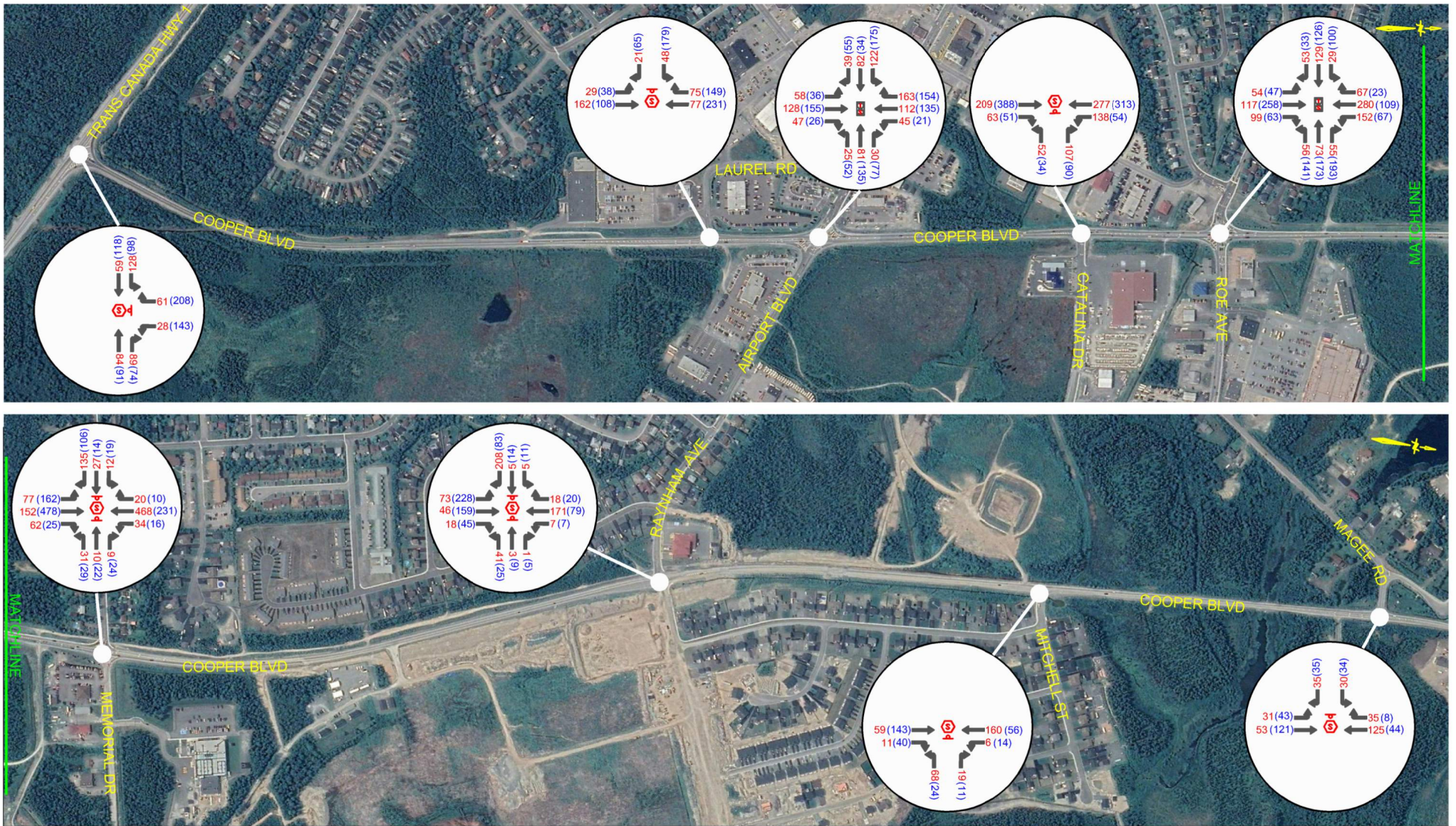

LEGEND:
 XXX AM PEAK HOUR VOLUME
 (XXX) PM PEAK HOUR VOLUME
 TRAFFIC SIGNAL
 STOP SIGN

3.0 EXISTING TRAVEL CONDITIONS

3.1 INTRODUCTION

This chapter summarizes a collision analysis and level of service analysis for the existing traffic conditions. The analysis is based on the existing traffic volumes which were displayed in **Figure 2**.

3.2 COLLISION ANALYSIS

A collision analysis was performed along Cooper Boulevard based on collision data provided by the Town of Gander’s Fire Department on incidents that occurred from 2014 to May of 2020 along Cooper Boulevard. It is important to note that Fire Department services are not required for all vehicle collisions, but only emergency situations. A complete list of collisions reported on Cooper Boulevard was not available and therefore, the following analysis is specific to the data made available to the Study Team.

Collision data were provided on 39 vehicle collisions that occurred along Cooper Boulevard from 2014 to 2020. Vehicle collision locations were provided as part of the data collected. **Figure 3** provides a breakdown of the reported collision locations along Cooper Boulevard. According to the data collected by the Town’s Fire Department, most incidents reported occurred at Cooper Boulevard and Roe Avenue at 28%, while the second most reported occurred at Cooper Boulevard and Trans Canada Highway 1 intersection at 25%. Intersections with no reported incidents were excluded from the graph. Of all incidents reported, 17 resulted in injuries and no fatalities were reported. The majority of injury collisions occurred at Cooper Boulevard/TCH intersection.

Figure 3 - Vehicle Collision Location along Cooper Boulevard

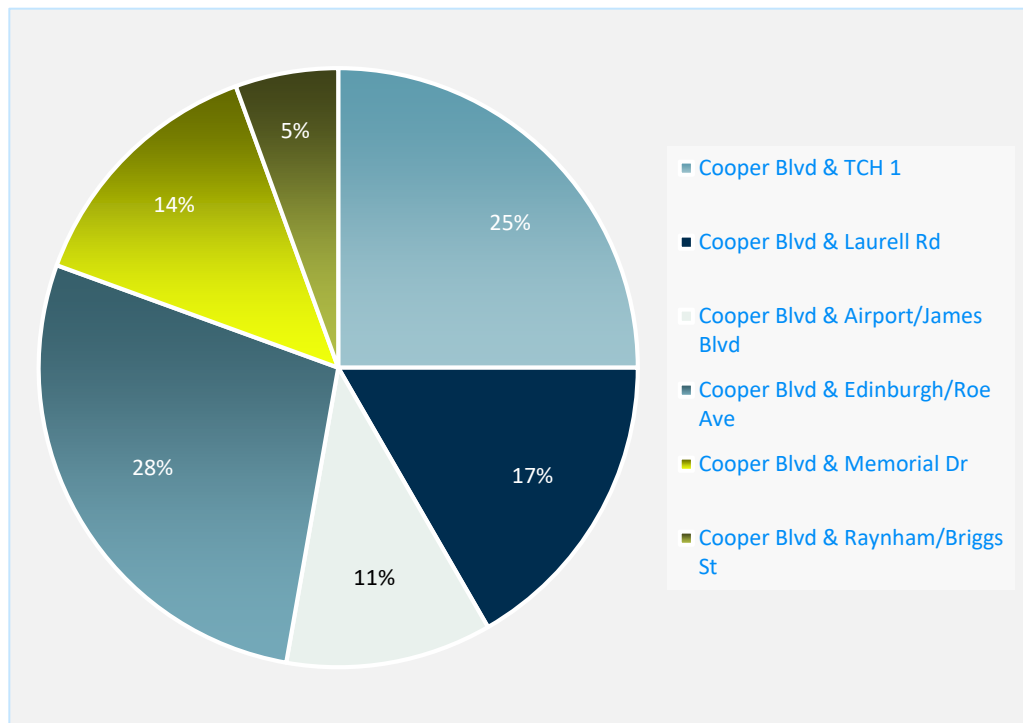



3.3 OPERATIONAL CONDITIONS



A level of service (LOS) analysis was completed for the 2020 traffic conditions using the methodology described in **Section 1.3**. The analysis indicated that all intersections within the Study Area currently operate efficiently overall, with the exception of the westbound approach of Cooper Blvd and Memorial Dr.



- The **Cooper Blvd @ Memorial Dr** intersection operates at an excellent overall LOS A during the PM peak period, but the westbound shared left/through/right movement operates at a LOS E with 43.7 seconds of delay.

The LOS results, including average delay, volume to capacity (v/c) ratios, and the 95th percentile queue lengths for the 2020 conditions are summarized in **Table 3 – Existing 2020 LOS Results**. The Synchro LOS reports are provided in **Appendix B**.

Table 3 – Existing 2020 LOS Results

Intersection			Overall LOS & Delay (sec/veh)	Turning Movement LOS Average Delay (seconds per vehicle) [Volume to Capacity Ratio (v/c)] 95 th Percentile Queue (m)											
				Eastbound			Westbound			Northbound			Southbound		
North South Street @ East West Street	Traffic Control	Time Period		L	T	R	L	T	R	L	T	R	L	T	R
				←	↑	→	←	↑	→	←	↑	→	←	↑	→
Cooper Blvd @ Magee Rd		AM Peak	LOS A 2.9	B 10.0 [0.09] 2	-	B 10.0 [0.09] 2	-	-	-	A 7.6 [0.02] <1	Free Flow [0.0]	-	-	Free Flow [0.10]	Shared
		PM Peak	LOS A 3.5	A 9.8 [0.09] 2	-	A 9.8 [0.09] 2	-	-	-	A 7.4 [0.03] <1	Free Flow [0.08]	-	-	Free Flow [0.03]	Shared
Cooper Blvd @ Mitchell St		AM Peak	LOS A 2.9	-	-	-	B 10.3 [0.12] 3	-	B 10.3 [0.12] 3	-	Free Flow [0.04]	A 0.0 [0.01] 2	A 7.4 [0.0] <1	Free Flow [0.10]	-
		PM Peak	LOS A 1.6	-	-	-	A 9.9 [0.05] 1	-	A 9.9 [0.05] 1	-	Free Flow [0.09]	A 0.0 [0.03] <1	A 7.6 [0.01] <1	Free Flow [0.04]	-
Cooper Blvd @ Raynham Ave		AM Peak	LOS A 6.3	Shared	B 10.9 [0.27] 9	B 10.9 [0.27] 9	Shared	C 17.7 [0.15] 4	Shared	A 7.8 [0.06] 2	Free Flow [0.03]	Free Flow [0.01]	A 7.3 [0.01] <1	A 0.0 [0.12] <1	Shared
		PM Peak	LOS A 5.8	Shared	B 11.7 [0.10] 3	B 11.7 [0.10] 3	Shared	C 22.0 [0.17] 5	Shared	A 7.9 [0.17] <1	Free Flow [0.10]	Free Flow [0.03]	A 7.6 [0.01] <1	A 0.0 [0.06] <1	Shared

Intersection			Overall LOS & Delay (sec/veh)	Turning Movement LOS Average Delay (seconds per vehicle) [Volume to Capacity Ratio (v/c)] 95 th Percentile Queue (m)											
				Eastbound			Westbound			Northbound			Southbound		
North South Street @ East West Street	Traffic Control	Time Period		L	T	R	L	T	R	L	T	R	L	T	R
				←	↑	→	←	↑	→	←	↑	→	←	↑	→
Cooper Blvd @ Memorial Dr		AM Peak	LOS A 5.9	Shared	C 20.1 [0.45] 18	Shared	Shared	D 32.3 [0.30] 9	Shared	A 8.8 [0.08] 2	Free Flow [0.14]	Shared	A 7.6 [0.03] <1	Free Flow [0.31]	Shared
		PM Peak	LOS A 6.7	Shared	C 21.0 [0.40] 15	Shared	Shared	E 42.3 [0.47] 18	Shared	A 8.2 [0.14] 4	Free Flow [0.32]	Shared	A 8.5 [0.02] <1	Free Flow [0.15]	Shared
Cooper Blvd @ Roe Ave		AM Peak	LOS C 25.8	B 18.4 [0.06] 10	C 34.3 [0.28] 44	A 0.4 [0.11] <1	B 19.0 [0.12] 16	C 30.9 [0.14] 27	A 0.4 [0.10] <1	B 18.0 [0.13] 15	C 28.8 [0.21] 37	B 10.2 [0.54] <1	B 19.3 [0.29] 36	C 32.3 [0.46] 85	A 5.1 [0.37] <1
		PM Peak	LOS C 26.2	B 18.0 [0.20] 25	C 32.5 [0.27] 41	A 0.2 [0.07] <1	B 18.5 [0.26] 33	C 33.9 [0.37] 55	A 6.2 [0.36] 18	B 18.3 [0.10] 14	C 34.2 [0.50] 80	A 4.6 [0.34] <1	B 19.5 [0.19] 18	C 30.2 [0.22] 35	A 1.3 [0.13] <1
Cooper Blvd @ Catalina Dr		AM Peak	LOS A 3.9	-	-	-	B 13.8 [0.20] 6	-	B 13.8 [0.20] 6	-	Free Flow [0.17]	Shared	A 8.2 [0.12] 3	Free Flow [0.18]	-
		PM Peak	LOS A 2.4	-	-	-	B 14.0 [0.16] 5	-	B 14.0 [0.16] 5	-	Free Flow [0.28]	Shared	A 8.5 [0.05] 1	Free Flow [0.20]	-

Intersection			Overall LOS & Delay (sec/veh)	Turning Movement LOS											
				Average Delay (seconds per vehicle) [Volume to Capacity Ratio (v/c)] 95 th Percentile Queue (m)											
North South Street @ East West Street	Traffic Control	Time Period		Eastbound			Westbound			Northbound			Southbound		
			L ←	T ↑	R →	L ←	T ↑	R →	L ←	T ↑	R →	L ←	T ↑	R →	
Cooper Blvd @ Airport Blvd		AM Peak	LOS C 20.2	B 19.7 [0.33] 27	C 21.9 [0.26] 31	Shared	B 17.6 [0.09] 8	C 31.5 [0.39] 32	Shared	B 12.3 [0.11] 13	B 19.4 [0.22] 41	Shared	B 12.0 [0.07] 11	B 19.0 [0.37] 59	Shared
		PM Peak	LOS C 28.1	C 20.2 [0.42] 37	B 15.9 [0.25] 19	Shared	B 16.3 [0.10] 13	D 36.6 [0.62] 58	Shared	B 13.8 [0.09] 9	C 30.9 [0.43] 50	Shared	B 11.5 [0.04] 6	C 33.7 [0.68] 76	Shared
Cooper Blvd @ Laurel Rd		AM Peak	LOS A 2.3	B 10.5 [0.10] 3	-	B 10.5 [0.10] 3	-	-	-	A 7.4 [0.02] <1	Free Flow [0.10]	-	-	Free Flow [0.05]	A 0.0 [0.05] <1
		PM Peak	LOS A 5.4	C 15.8 [0.45] 18	-	C 15.8 [0.45] 18	-	-	-	A 7.8 [0.03] <1	Free Flow [0.07]	-	-	Free Flow [0.15]	A 0.0 [0.10] <1
Cooper Blvd @ Trans Canada Highway 1		AM Peak	LOS A 4.2	A 7.6 [0.09] 2	Free Flow [0.04]	-	-	Free Flow [0.05]	A 0.0 [0.06] <1	-	-	-	B 10.4 [0.13] 3	-	B 10.4 [0.13] 3
		PM Peak	LOS A 8.4	A 7.6 [0.07] 2	Free Flow [0.08]	-	-	Free Flow [0.06]	A 0.0 [0.05] <1	-	-	-	C 15.4 [0.53] 25	-	C 15.4 [0.53] 25

4.0 FUTURE TRAVEL CONDITIONS ANALYSIS

4.1 INTRODUCTION

This chapter presents the development assumptions and traffic volume projections, planned road network changes, and the LOS results for the 10-year horizon period. The future traffic volumes for the 10-year horizon periods were estimated by adding a combination of background traffic growth and additional trips generated for other potential development along Cooper Blvd to the existing traffic volumes. The land use assumptions and estimated build-out rates of future development along Cooper Blvd are discussed in this section.

4.2 10-YEAR HORIZON PERIOD TRAFFIC VOLUMES

The 10-year traffic volumes were estimated by applying a 1.0% annual growth rate to the existing traffic volumes and adding the 10-year development traffic (see **Section 4.3**). AADT volumes for segments of the corridor are shown in **Table 4**. The AM and PM peak hour traffic volume projections for the 10-year horizon period are displayed in **Figure 5**.

Table 4 - 10-Year AADT Volume by Corridor Segment

Corridor Segment	AADT
Magee Rd to Raynham Ave	6,830 veh/day
Raynham Ave to Memorial Dr	14,000 veh/day
Memorial Dr to Airport Blvd	15,800 veh/day
Airport Blvd to TCH 1	10,500 veh/day

4.3 COOPER BOULEVARD DEVELOPMENT ASSUMPTIONS

Three planned developments and their traffic studies (if available) were assessed as a part of this analysis:

- the Eastgate development, a residential development located between Mitchell St and 700m south of Raynham Ave along the east side of Cooper Boulevard;
- the Penney Avenue Extension (as part of the Gander Elementary School development) and future residential development, proposed to connect north of Raynham Ave, on the westside of Cooper Boulevard; and
- the Gander Landing development, a mixed-use development located on the east side of Cooper Boulevard between Roe Avenue and Airport Boulevard /James Boulevard.

Each planned development is explained in depth below and the site locations are displayed in **Figure 4**.

Eastgate Development

Traffic data from the proposed Eastgate development was included as part of this Study. This development is located between Mitchell St and 700m south of Raynham Ave (Briggs St) along the east

side of Cooper Blvd. The development consists of 469 residential units and retirement homes and a new roadway (Cessna St) proposed off the east end of Cooper Blvd, 470m south of Raynham Ave. The development has been under construction for a number of years and according to the developer's website, 227 residential lots, 73 units of the senior complex, and a 100 tenant senior complex were completed as of 2019. Lots are being constructed at 40 lots per year, making the full build-out in 2025. Therefore, it is assumed that the Eastgate development, including the planned Cessna St, would be completed by the horizon year 2030.

Penney Avenue Extension

In August 2017, Crandall Engineering, Ltd. was retained by NL Transportation and Works to complete a TIS for Gander Elementary School, which has since opened. The Penney Ave extension and residential development was also included in the previous TIS. This development includes a 74 unit residential development and extension of Penney Ave to intersect with Cooper Blvd, approximately 300m north of Raynham Avenue. The Penney Ave extension and 74 unit residential development is included in this Study. Construction of the new street is expected to be completed in 2022 and the adjacent 74-unit development is assumed to be built-out by 2030. Traffic volume estimates for the peak hours were distributed at the future Penney Ave and Cooper Blvd intersection with the development in place.

Gander Landing Development

In 2017, Stantec performed a traffic study regarding the Airport Authority's Gander Landing mixed-use development and proposed collector roads located between Roe Ave and James Blvd, east of Cooper Blvd. Three collector roads are proposed through the site. "Collector A" is a north-south roadway which begins at Roe Ave, then heads south and intersects with Catalina Dr and then James Blvd, and finally hooks west to intersect with Cooper Blvd approximately 240m south of James Blvd. The section of "Collector A" between Roe Ave and Catalina Dr has been constructed. The second proposed road is a 530m extension of Catalina Drive to Circular Dr. Lastly, "Collector B" is a 530m east-west roadway from Garret Dr to the new north-south "Collector A" roadway. According to recent discussions with the Airport Authority, Gander Landing development will consist of general office space, retail space, and an industrial business park situated along these proposed roads. The Study Team divided the developable land into 3 phases of development that would be developed within the 10-year horizon. Phase 1 of Gander Landing, located along Catalina Dr, consists of 264,000 SF of office space and 166,000 SF of retail. Phase 2, located north of James Blvd along Collector A and Collector B, consists of 302,700 SF of industrial office space and 145,000 SF of retail. Phase 3, located south of James Blvd along Collector B, consists of 50,000 SF of retail. Trip generations assumed in the 2017 TIS by Stantec showed similar values to those generated in this study but with some variation of the proposed development and additional trip reductions made for site internal capture and pass-by trips. The trip generations used in this study are more conservative and better reflect a worst-case scenario for traffic impacts by the proposed development.

The developable land phases and proposed roadways are shown in **Figure 4** and the land use assumptions are summarized below in **Table 5**.

FIGURE 4 - PLANNED DEVELOPMENT ALONG COOPER BOULEVARD



LEGEND:

- PROPOSED DEVELOPMENT
- FUTURE ROADWAYS

Table 5 – Land Uses and Build-Out Estimates

Development	Location	ITE Land Use #	10-Year Build-Out	Total	Units
Eastgate Development	Mitchell St to Raynham Ave	210 – Single Family House	242	454	units
Penney Ave Development and Extension	300m north of Raynham Ave	210 – Single Family House	74	74	units
		520 – Elementary School	-	420	students
Gander Landing Development – Phase 1	Roe Ave to Catalina Dr	820 – Shopping Center	166,000	166,000	sq. ft.
		710 – General Office	264,000	264,000	sq. ft.
Gander Landing Development – Phase 2	Collector B to James Blvd	820 – Shopping Center	145,000	145,000	sq. ft.
		130 – Industrial Park	302,700	302,700	sq. ft.
Gander Landing Development – Phase 3	Roe Ave to Catalina Dr	820 – Shopping Center	50,000	50,000	sq. ft.

The Study Team generated trips for each land use of each planned development based on a combination of ITE trip generation rates. A 20% reduction was applied to the Gander Landing retail site traffic to account for site synergy (customers who will stop at more than one development during one trip to the site). The land uses and the trips generated for the 10-year horizon are summarized in **Table 6**.

Table 6 – 10-Year Trip Generation

Development	ITE Land Use #	Size	AM Peak Hour			PM Peak Hour		
			In	Out	Total	In	Out	Total
Eastgate Development	210 - Single Family House	242 lots	44	133	177	149	88	237
Penney Avenue Development and Extension	210 - Single Family House	74 lots	15	42	57	49	28	77
Gander Landing Phase 1	820 – Shopping Center	166,000 SF	146	89	235	379	412	791
		264,000 SF	236	39	275	46	241	287
Gander Landing Phase 2	820 – Shopping Center	145,000 SF	139	85	224	344	372	716
		302,700 SF	98	23	121	25	96	121
Gander Landing Phase 3	820 – Shopping Center	50,000 SF	29	18	47	92	99	191
Subtotal	-	-	707	429	1136	1084	1336	2420
Synergy Adjustment (20%)	-	-	-79	-48	-127	-176	-191	-367
Total Trip Generation	-	-	628	381	1009	908	1145	2053

4.4 TRAFFIC GENERATION AND ASSIGNMENT

The future development traffic was assigned to the network based on the existing distribution of traffic currently utilizing Cooper Boulevard. This was determined using the 2020 turning movement counts at major intersections along Cooper Boulevard. Traffic was added to the network according to the distributions shown in **Table 7**.

Table 7 – Origin-Destination of Traffic Entering and Exiting the Network

Origin-Destination Region	Distribution
Cooper Blvd (North)	5%
Magee Rd	5%
Raynham Ave	5%
Memorial Dr	10%
Roe Ave	14%
Airport Boulevard	25%
Laurel Rd	8%
TCH 1 (West)	18%
TCH 1 (East)	10%

The background traffic growth and additional trips generated by the planned developments along Cooper Boulevard were combined to generate the future traffic projections for the 10-year horizon period (2030) and are presented in **Figure 5** below.

4.5 10-YEAR ESTABLISHED GEOMETRIC IMPROVEMENTS

The Study Team has assumed that the following geometric improvements, which are planned as part of the future developments previously discussed, will be completed within the next 10 years:

- Penney Ave extension is completed to Cooper Blvd;
- Catalina Dr extension is complete;
- Collector A extension is complete;
- Collector B extension is complete;
- Cessna St extension is completed to Cooper Blvd.

The geometric improvements described above were included in the LOS analyses for the 10-year horizon period.

FIGURE 5 - 2030 PROJECTED TRAFFIC VOLUMES

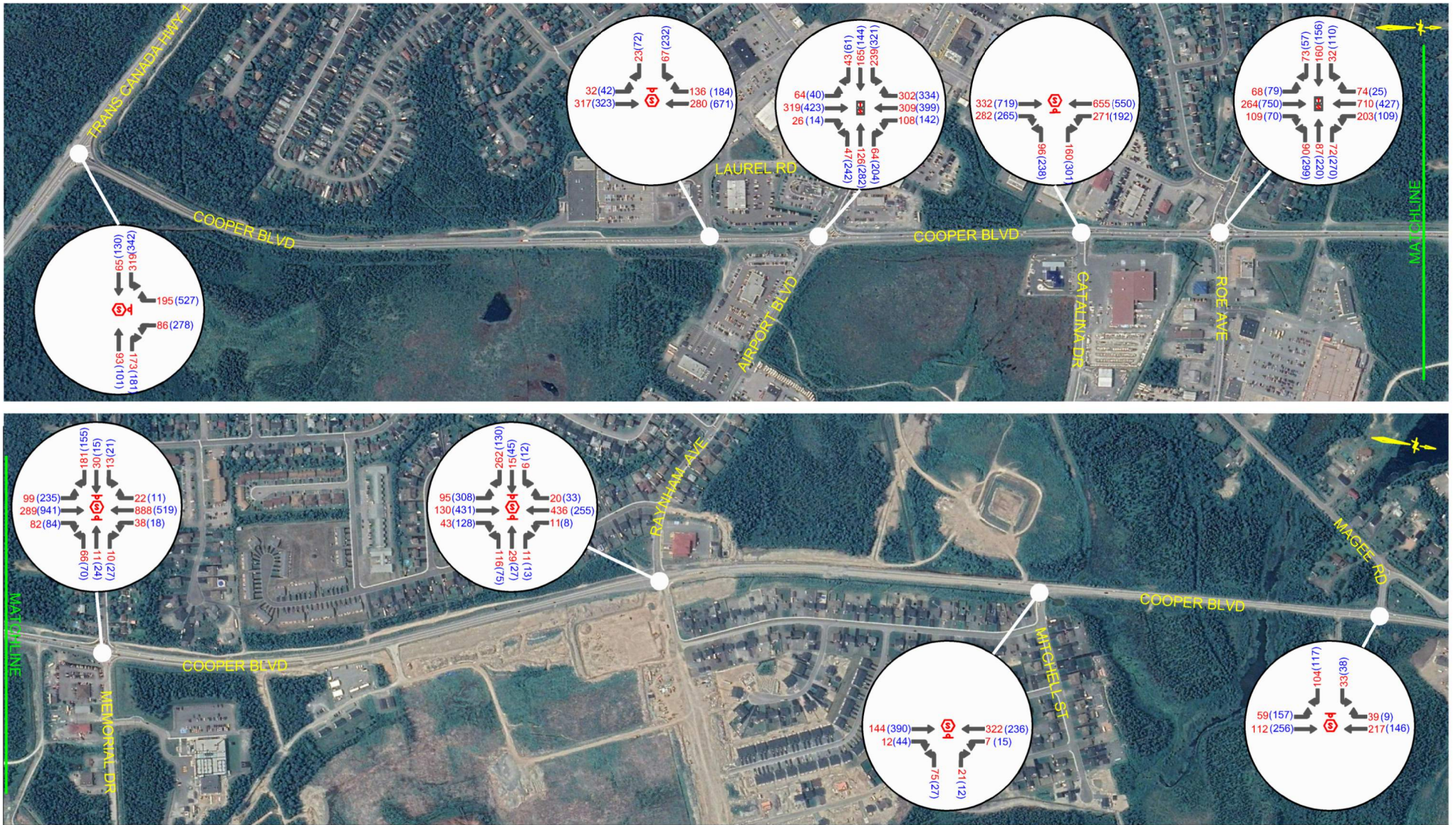

LEGEND:
 XXX AM PEAK HOUR VOLUME
 (XXX) PM PEAK HOUR VOLUME
 TRAFFIC SIGNAL
 STOP SIGN

4.6 10-YEAR OPERATIONAL CONDITIONS

The LOS analysis was completed for the 10-year horizon period Do-Nothing condition using the traffic volumes displayed in **Figure 5** and assuming the geometric improvements identified in **Section 4.5** are complete. The analysis revealed several issues that are expected to occur as traffic volumes increase. Generally, there are significant increases in delay at the minor approaches of most stop-controlled intersections due to increased through traffic on Cooper Boulevard, which reduces gaps in the traffic stream, and an increase in side street traffic demand from development areas. The 10-year operational issues are discussed below.



- The **Cooper Blvd @ Raynham Ave** intersection will operate at an overall LOS B during the AM peak hour and LOS F with 79 seconds of delay during the PM peak hour. During the AM peak the westbound left/through/right movements operate at LOS F with 285.4 seconds of delay and a v/c ratio of 1.39. During the PM peak the eastbound through/left and right turn movements operate at LOS F with 65.2 seconds of delay, and the westbound shared left/through/right turn movements operate at LOS F with 876.3 seconds of delay and a v/c ratio of 2.54. The westbound 95th percentile queue length during the AM peak is 92m and during the PM peak is 105m.
- The **Cooper Blvd @ Memorial Dr** intersection will operate at an overall LOS F during the AM and PM peak hours with 531 seconds of delay and 1,469 seconds of delay, respectively. The eastbound left/through/right movements operate at LOS F with 191 seconds of delay and a v/c ratio of 1.24 in the AM peak hour and 999 seconds of delay and a v/c ratio of 3.46 in the PM peak hour. The AM peak 95th percentile queue length is 104m and the PM peak is beyond measurable. The westbound left/through/right movements operate at LOS F with 999 seconds of delay and a v/c ratio of 4.29 in the AM peak hour and 999 seconds of delay and a v/c ratio of 7.57 in the PM peak hour. Both 95th percentile queue lengths are beyond measurable.
- The **Cooper Blvd @ Roe Ave** intersection will operate at an overall LOS E with 58.5 seconds of delay during the AM peak hour and LOS D with 50.8 seconds of delay during the PM peak hour. During the AM peak the southbound through movement operates at LOS F with 111.4 seconds of delay and a v/c ratio of 1.15. The southbound 95th percentile queue length is 258m. During the PM peak the westbound left turn movement operates at LOS E with 64.4 seconds of delay and a v/c ratio of 0.93, and the northbound through/right movements operate at LOS F with 90.0 seconds of delay and a v/c ratio of 1.10. The northbound 95th percentile queue length is 284m.
- The **Cooper Blvd @ Catalina Dr** intersection will operate at an overall LOS F during the AM and PM peak hour. During both the AM and PM peak hours, the westbound approach performs at LOS F with 999 seconds of delay. Both 95th percentile queue lengths are beyond measurable.
- The **Cooper Blvd @ Airport Blvd** intersection will operate at an overall LOS D during the AM peak hour with 38.4 seconds of delay and LOS F with 103.4 seconds of delay during the PM peak hour. During the AM peak the southbound through/right movements operate at LOS D with 52.5 seconds of delay and a v/c ratio of 0.92. During the PM peak the eastbound left movement operates at LOS F with 161.7 seconds of delay and a v/c ratio of 1.23, the westbound through/right turn movements operate at LOS F with 145.7 seconds of delay and a v/c ratio of 1.19, and the southbound through/right movements operate at LOS F with 128.6 seconds of



delay and a v/c ratio of 1.18. The westbound 95th percentile queue length during the PM peak is 223m and in the southbound direction it is 328m.

- The **Cooper Blvd @ Laurel Rd** intersection will operate at an overall LOS A in the AM peak hour and LOS B in the PM peak period. During the PM peak the eastbound left/right movements operate at LOS F with 132.2 seconds of delay and a v/c ratio of 1.13. The eastbound 95th percentile queue length is 111m.
- The **Cooper Blvd @ Trans Canada Highway 1** intersection will operate at an overall LOS A in the AM peak hour and LOS F in the PM peak period with 271.2 seconds of delay. During the PM peak the southbound left/right movements operate at LOS F with 521.8 seconds of delay and a v/c ratio of 2.09. The southbound 95th percentile queue length is 499m.

The LOS results, including average delay, volume to capacity (v/c) ratios, and the 95th percentile queue lengths for the 10-year horizon are summarized in **Table 8**. The Synchro LOS reports are provided in **Appendix B**. Improvement options to mitigate these delays are discussed in **Chapter 5.0**.

Table 8 – Future 2030 LOS Results

Intersection			Overall LOS & Delay (sec/veh)	Turning Movement LOS											
				Eastbound			Westbound			Northbound			Southbound		
North South Street @ East West Street	Traffic Control	Time Period		L	T	R	L	T	R	L	T	R	L	T	R
				←	↑	→	←	↑	→	←	↑	→	←	↑	→
Cooper Blvd @ Magee Rd		AM Peak	LOS A 3.7	B 11.7 [0.22] 7	-	B 11.7 [0.22] 7	-	-	-	A 7.9 [0.05] 1	Free Flow [0.07]	-	-	Free Flow [0.16]	Shared
		PM Peak	LOS A 4.5	B 13.0 [0.27] 9	-	B 13.0 [0.27] 9	-	-	-	A 7.9 [0.12] 3	Free Flow [0.16]	-	-	Free Flow [0.10]	Shared
Cooper Blvd @ Mitchell St		AM Peak	LOS A 2.2	-	-	-	B 12.8 [0.19] 5	-	B 12.8 [0.19] 5	-	Free Flow [0.09]	A 0.0 [0.01] <1	A 7.5 [0.01] <1	Free Flow [0.21]	-
		PM Peak	LOS A 0.9	-	-	-	B 13.9 [0.09] 3	-	B 13.9 [0.09] 3	-	Free Flow [0.25]	A 0.0 [0.03] <1	A 8.2 [0.03] <1	Free Flow [0.15]	-
Cooper Blvd @ Penney Ave		AM Peak	LOS A 2.8	B 12.8 [0.24] 7	-	B 12.8 [0.24] 7	-	-	-	A 1.6 [0.02] 1	Free Flow [0.02]	-	-	Free Flow [0.25]	Shared
		PM Peak	LOS A 2.0	B 11.4 [0.16] 5	-	B 11.4 [0.16] 5	-	-	-	A 1.2 [0.04] 1	Free Flow [0.04]	-	-	Free Flow [0.17]	Shared

Intersection			Overall LOS & Delay (sec/veh)	Turning Movement LOS Average Delay (seconds per vehicle) [Volume to Capacity Ratio (v/c)] 95 th Percentile Queue (m)											
				Eastbound			Westbound			Northbound			Southbound		
North South Street @ East West Street	Traffic Control	Time Period		L	T	R	L	T	R	L	T	R	L	T	R
Cooper Blvd @ Memorial Dr		AM Peak	LOS F 530.9	Shared	F 191.0 [1.24] 104	Shared	Shared	F ERR [4.29] ERR	Shared	B 11.1 [0.15] 4	Free Flow [0.24]	Shared	A 8.0 [0.03] <1	Free Flow [0.58]	Shared
		PM Peak	LOS F 1468.7	Shared	F ERR [3.46] ERR	Shared	Shared	F ERR [7.57] ERR	Shared	A 9.8 [0.26] 8	Free Flow [0.66]	Shared	B 10.5 [0.03] <1	Free Flow [0.34]	Shared
Cooper Blvd @ Roe Ave		AM Peak	LOS D 37.7	C 24.9 [0.07] 13	D 45.0 [0.42] 16	A 2.2 [0.17] 3	C 26.9 [0.24] 29	D 38.0 [0.18] 36	A 1.8 [0.14] 3	C 24.1 [0.43] 18	C 30.9 [0.41] 80	A 4.4 [0.17] 11	B 19.9 [0.45] 46	E 63.0 [0.97] 296	A 1.2 [0.11] 3
		PM Peak	LOS D 43.2	C 26.8 [0.30] 34	D 47.0 [0.42] 62	A 0.6 [0.14] <1	D 36.3 [0.69] 90	D 44.8 [0.50] 82	A 9.9 [0.49] 33	B 17.9 [0.25] 21	E 67.9 [1.00] 307	A 2.2 [0.10] 6	F 87.7 [0.93] 56	D 35.9 [0.63] 139	A 0.1 [0.04] <1
Cooper Blvd @ Catalina Dr		AM Peak	LOS F ERR	-	-	-	F ERR [4.02] ERR	-	F ERR [4.02] ERR	-	Free Flow [0.39]	Shared	B 10.7 [0.32] 11	Free Flow [0.42]	-
		PM Peak	LOS F 2380	-	-	-	F ERR [10.52] ERR	-	F ERR [10.52] ERR	-	Free Flow [0.63]	Shared	B 13.1 [0.32] 11	Free Flow [0.35]	-

Intersection			Overall LOS & Delay (sec/veh)	Turning Movement LOS Average Delay (seconds per vehicle) [Volume to Capacity Ratio (v/c)] 95 th Percentile Queue (m)											
				Eastbound			Westbound			Northbound			Southbound		
North South Street @ East West Street	Traffic Control	Time Period		L	T	R	L	T	R	L	T	R	L	T	R
				←	↑	→	←	↑	→	←	↑	→	←	↑	→
Cooper Blvd @ Airport Blvd		AM Peak	LOS C 34.2	E 55.4 [0.86] 84	C 28.0 [0.42] 60	Shared	C 22.3 [0.05] 7	D 40.0 [0.64] 55	Shared	B 13.7 [0.29] 13	C 23.3 [0.49] 88	Shared	B 11.4 [0.23] 19	D 38.7 [0.88] 200	Shared
		PM Peak	LOS F 104.5	F 198.3 [1.31] 184	C 33.4 [0.34] 72	Shared	C 28.0 [0.10] 13	F 163.6 [1.23] 263	Shared	C 22.6 [0.29] 12	D 39.4 [0.65] 155	Shared	C 20.5 [0.33] 27	F 102.0 [1.11] 372	Shared
Cooper Blvd @ Laurel Rd		AM Peak	LOS A 2.0	B 14.6 [0.21] 6	-	B 14.6 [0.21] 6	-	-	-	A 7.8 [0.03] <1	Free Flow [0.20]	-	-	Free Flow [0.14]	A 0.0 [0.09] <1
		PM Peak	LOS B 29.6	F 132.2 [1.13] 111	-	F 132.2 [1.13] 111	-	-	-	A 8.7 [0.05] 1	Free Flow [0.21]	-	-	Free Flow [0.33]	A 0.0 [0.12] <1
Cooper Blvd @ Trans Canada Highway 1		AM Peak	LOS A 9.4	A 8.1 [0.23] 7	Free Flow [0.04]	-	-	Free Flow [0.06]	A 0.0 [0.11] <1	-	-	-	C 21.9 [0.60] 31	-	C 21.9 [0.60] 31
		PM Peak	LOS F 271.2	A 8.2 [0.25] 2	Free Flow [0.08]	-	-	Free Flow [0.06]	A 0.0 [0.12] <1	-	-	-	F 521.8 [2.09] 499	-	F 521.8 [2.09] 499

5.0 COOPER BOULEVARD CORRIDOR CONCEPT DESIGN

This chapter summarizes the future vision of the Cooper Boulevard corridor and discusses the functional requirements and improvement options.

The 2030 horizon year conditions were analyzed and mitigation measures reviewed for each intersection significantly impacted by traffic growth. The analysis showed improvements are required in the interim in addition to full intersection upgrades required in 2030. This section reviews roadway infrastructure improvements to Cooper Boulevard and their results. Two corridor options have been proposed for Cooper Boulevard, one considering traffic signal upgrades and the other considering roundabouts, as further discussed in the sections below.

5.1 TRAFFIC SIGNAL WARRANT ANALYSIS

Traffic signal warrant analyses (TSWA) were completed using the TAC methodology, which is documented in the *Traffic Signal and Pedestrian Signal Head Warrant Handbook (2014)*. This methodology considers the following intersection characteristics:

- Six-hour turning movement and pedestrian volumes covering the AM, Noon, and PM peaks;
- Intersection geometry (lane configurations, spacing, right-turn slip lanes, etc.);
- Adjacent land uses (schools, mobility challenged citizens, senior citizen complexes, etc.);
- Distance of nearest upstream traffic signals;
- Population of community;
- Location within the community (central business district, etc.); and
- Percentage of heavy vehicles.

The TAC methodology determines the need for a traffic signal based on a priority point system using the characteristics described above. Each characteristic contributes toward the justification of a traffic signal. If the signal warrant generates 100 points or more then traffic signals are typically warranted.

After reviewing the traffic impacts to each intersection along Cooper Boulevard, five (5) stop-controlled intersections were selected for a TSWA that could benefit from a traffic signal operation. The results of the TSWA are documented below in **Table 9**. Signal warrant worksheets are provided in **Appendix C**.

Table 9 – Traffic Signal Warrant Analysis Results

Intersection	Signal Warrant Threshold	2030 Priority Points	Signal Warranted?
Raynham Ave at Cooper Blvd	100	75	No
Memorial Dr at Cooper Blvd	100	116	Yes
Catalina Dr at Cooper Blvd	100	124	Yes
Laurel Rd at Cooper Blvd	100	54	No
TCH 1 at Cooper Blvd	100	57	No

The signal warrant results show a traffic signal is warranted at two intersections: Memorial Drive at Cooper Boulevard with 116 priority points and Catalina Drive at Cooper Boulevard with 124 priority

points. Raynham Avenue at Cooper Blvd intersection scored 75 priority points, Laurel Rd at Cooper Blvd intersection scored 54 priority points, and TCH 1 at Cooper Blvd intersection scored 57 priority points. This indicates that a traffic signal is not warranted at these intersections at the 2030 horizon year. Memorial Dr at Cooper Blvd and Catalina Dr at Cooper Blvd are further analyzed with a traffic signal operation in the next section.

5.2 INTERSECTION CAPACITY IMPROVEMENTS

The following improvements are recommended to be implemented by year 2030 to address operational deficiencies arising from the projected traffic growth:

- **Cooper Boulevard/Raynham Avenue:** Install eastbound right turn lane with 50.0m of storage.
- **Cooper Boulevard/Memorial Drive:** Install an actuated traffic signal with the following lane configuration:
 - Northbound approach: dedicated left turn lane, thru lane, and a thru/right lane;
 - Southbound approach: dedicated left turn lane and a thru/right channelized lane;
 - Eastbound approach: Channelized right turn lane with 20.0m of storage, and a thru/left turn lane; and
 - Westbound approach: Dedicated left turn lane with 35.0m of storage, and a thru/right channelized lane.
- **Cooper Boulevard/Roe Avenue:** Widen the intersection to provide larger interior space for left turning trucks. This will require relocation of the concrete islands and associated traffic signal equipment. Widen Cooper Boulevard to provide two thru-lanes, a separate lane turn lane and separate right turn lane in the northbound and southbound directions.
- **Cooper Boulevard/Catalina Drive:** Install an actuated traffic signal and widen Cooper Boulevard to provide two northbound thru lanes. Covert the southbound approach to have a southbound thru lane and southbound thru-left lane. The southbound approach would operate with a leading permitted/protected left turn signal phase.
- **Cooper Boulevard/Airport Boulevard:** The following improvements at this intersection are recommended:
 - Construct a westbound channelized right turn lane with 100.0m of storage;
 - Widen the intersection to all for left turning movements of tractor trailers within encroachment on other lanes.
 - Extend the eastbound left turn lane to 50m of storage.
 - Reconfigure the driveways to McDonalds on Airport Boulevard to be right-in/right out only.
- **Cooper Boulevard/TCH 1:** Install a dedicated southbound right turn lane with 150.0m of storage.

The above intersection improvements at Memorial Drive, Roe Avenue, and Cataline Road include an additional through lane on Cooper Boulevard in the northbound and southbound directions. Therefore, it

would make sense to provide a continuous four lane road section from Memorial Drive to Airport Boulevard rather than starting and ending the through lanes between intersections.

5.3 ROUNDABOUT ANALYSIS

Alternatives to the signalized upgrades proposed above would be the installation of roundabouts. The general benefits of roundabouts and the candidate locations for installations are discussed below.

General Benefits of Roundabouts

Roundabouts provide several benefits over conventional intersections. This type of intersection provides motorists with a safer environment, while also offering operational, environmental and economic benefits. The general benefits of roundabouts are outlined and discussed below.

Safety

Roundabouts offer a safer environment for motorists by reducing the frequency and severity of collisions. When compared to stop-controlled and signalized intersections, roundabouts have significantly fewer conflict points. This is because vehicles travel in the same direction, therefore eliminating right-angle and left-turn conflicts. As illustrated in **Figure 6**, single lane roundabouts have eight vehicle conflict points compared to the 32 vehicle conflict points of a typical 4-way intersection.

Figure 6 – Conflict Point Comparison between Roundabouts and Traditional Intersections

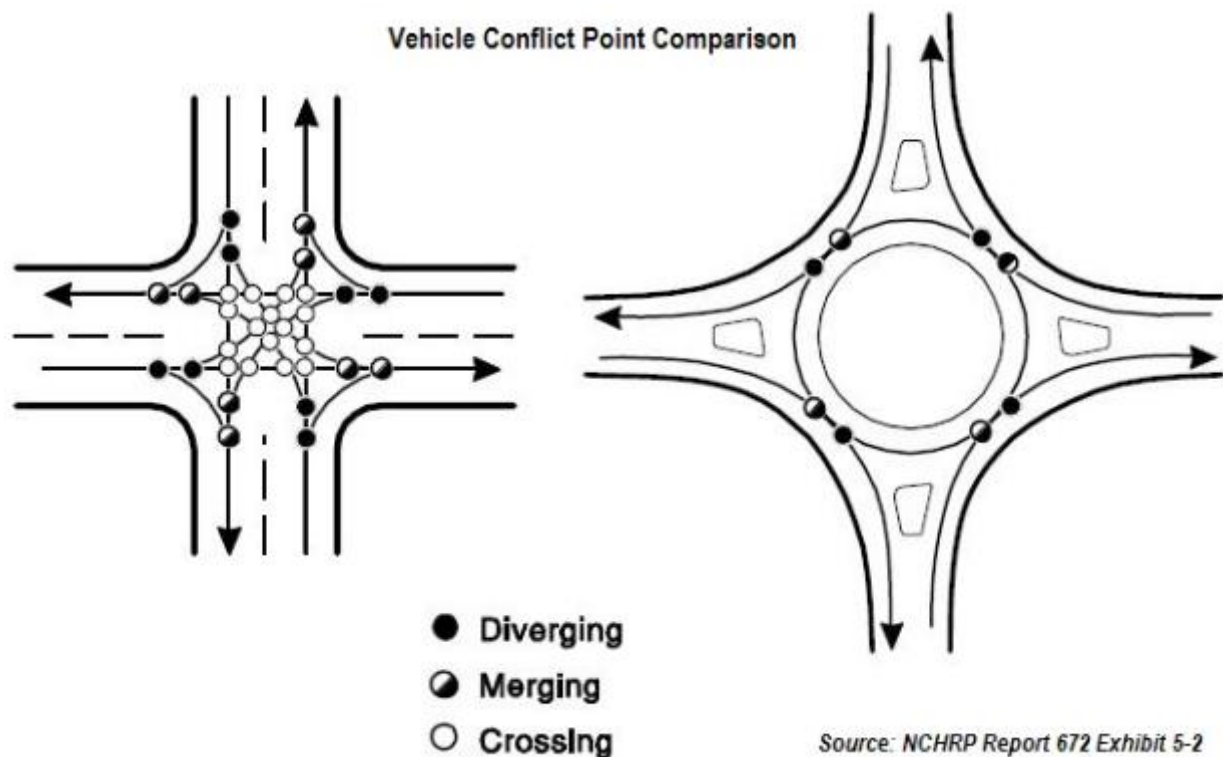

Additionally, the geometric characteristics of roundabouts promote reduced operating speeds, regardless of time of day or level of congestion. Reductions in entering and circulating speeds allow for improved reaction times for users and lowers the frequency and severity of collisions. Lowered vehicle speed is also

beneficial to other road users, such as pedestrians and cyclists. Roundabouts also provide deflection for entering vehicles, which reduces the angle of impact during collisions.

Collision modification factors (CMFs) from the AASHTO Highway Safety Manual provide a measure of the safety effectiveness of a particular design treatment or element. The CMF's for converting to roundabouts from stop-controlled and signalized intersections are as follows:

- CMF for Converting Stop-Controlled to Single Lane Roundabout = 0.29 (71% reduction)
- CMF for Converting Signalized to Roundabout = 0.52 (48% reduction).

The above values indicate that single lane roundabouts provide superior safety performance compared to both stop controlled and signalized treatments, resulting in 48%-71% fewer collisions on average. Additionally, there is a further reduction in the frequency of severe collisions given that roundabouts effectively eliminate head-on and right-angle crashes and reduce traffic speeds.

Operation

The low operating speeds at roundabouts result in improved gap acceptance for drivers. This means that a driver entering a roundabout does not require as large of a gap in circulating traffic to enter because the circulating traffic is not moving as fast. Additionally, unlike other types of intersections, roundabouts do not require vehicles to stop unnecessarily when no other vehicles are present. When queues are present, the traffic within these queues typically continues to move, which is usually more bearable for drivers than a stopped queue.

Environment

Roundabouts reduce fuel consumption and emissions by reducing delays and idling times for vehicles. These intersections allow traffic to travel without having to come to unnecessary stops, thus reducing accelerations and decelerations that lead to higher fuel consumption. Additionally, roundabouts are more sustainable than traffic signals as they consume less energy and require minimal maintenance.

Economic

Although upfront costs of roundabouts can be greater than those of traditional intersections, their long-term cost savings benefits are undeniable. Roundabouts require minimal maintenance, reduce travel times and reduce collision frequencies and severities, all of which have associated economic benefits. By reducing maintenance requirements, life-cycle costs associated with roundabouts are often less than those associated with conventional intersections. Travel time reductions reduce costs associated with fuel consumption as well as offer time savings for users. Finally, roundabouts provide societal cost benefits by reducing the frequency and severity of collisions.

Cooper Boulevard Proposed Roundabout Locations

Three (3) intersections were considered as potential roundabout locations along Cooper Boulevard. The Study Team reviewed the existing ROW to determine if roundabouts would be feasible at the study intersections, which included the following:

- Cooper Boulevard at Memorial Drive;
- Cooper Boulevard at Roe Avenue; and
- Cooper Boulevard at Airport Boulevard.

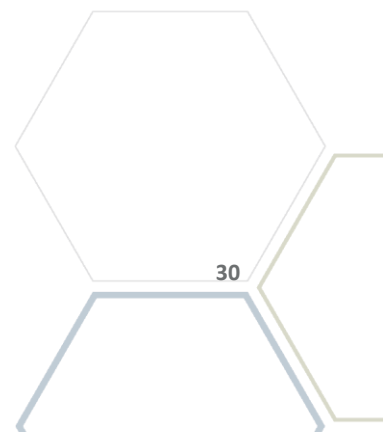

Memorial Drive at Cooper Boulevard

The proposed roundabout at Memorial Drive at Cooper Boulevard would have single lane approaches on each leg, with 4.2m entry widths. The roundabout would have an inscribed diameter of 40.0m. A crosswalk and raised sidewalks with ramps would be present on the west and south legs. The adjacent property driveway in the northwest corner of the intersection would require relocating further west so that it does not conflict with the splitter island. It does not appear that property acquisition would be required but this would be confirmed during more detailed design.

The intersection poses desirable conditions for the Town’s first roundabout, given it would be a single lane roundabout with relatively balanced traffic volumes and square geometry. A concept drawing for the proposed roundabout is provided in **Figure 7** below and in **Appendix D**. The geometry proposed includes a central truck apron that would allow for the turning movement of tractor trailers.

Figure 7 - Memorial Drive at Cooper Boulevard Roundabout Concept



Roe Avenue at Cooper Boulevard

The proposed roundabout at this location would have multi-lane approaches on the east and north legs as well as a right turn by-pass lane on the south lane. With the exception of the southbound entry, the roundabout would have a single circulating lane which simplifies its operation. The single lane entry widths would be 4.2m and the roundabout would have an inscribed diameter of 40.0m. A crosswalk and raised sidewalks with ramps would be present at each approach. Edinburgh Avenue at Elizabeth Drive intersection poses a challenge due to its proximity, but eastbound queuing at the roundabout is expected to reduce compared to a signalized option and therefore, queue backups and conflicts at Edinburgh/Elizabeth would be expected to reduce. Minor property acquisition is expected in the northeast and southeast corners.

A concept drawing for the proposed roundabout is provided in **Figure 8** below and in **Appendix D**. The geometry proposed includes a central truck apron that would allow for the turning movement of tractor trailers.

Figure 8 - Roe Avenue at Cooper Boulevard Roundabout Concept

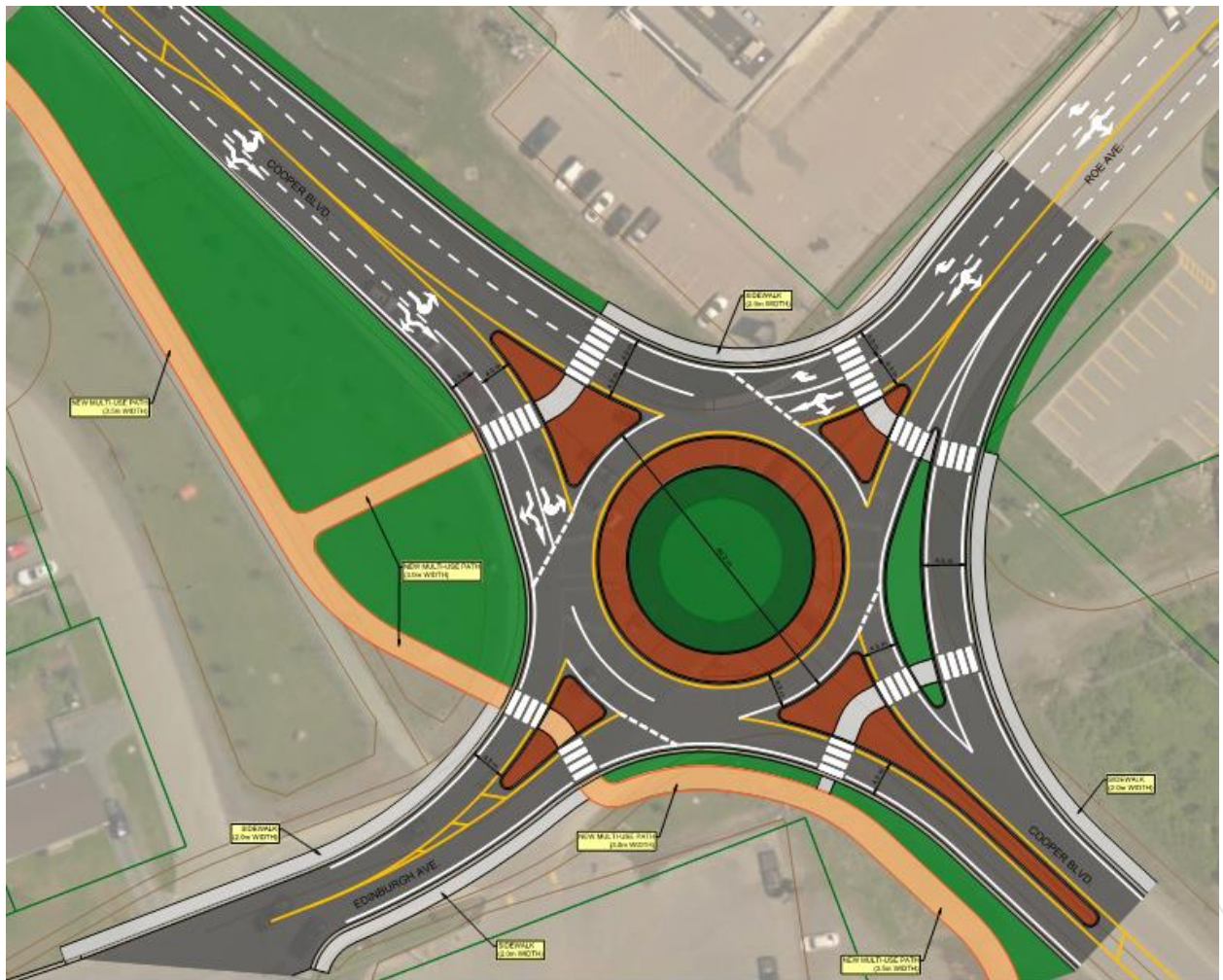

Airport Boulevard at Cooper Boulevard

The proposed roundabout at this location would have single lane entries on all approaches plus right turn by-pass lanes on the south and north of Cooper Boulevard. All lanes would have 4.2m entry widths. The roundabout would have an inscribed diameter of 40.0m. A crosswalk and raised sidewalks with ramps would be present on the west and south legs. The angle of Airport Boulevard requires property acquisition along the west side of Cooper Blvd; however, there is a possibility Cooper Blvd can be realigned to the east at this intersection which would remain within existing ROW. A more detailed design would confirm ROW requirements for both options.

A roundabout would address the skewed intersection angle at this location and improve operations and safety. A concept drawing for the proposed roundabout is provided in **Figure 9** below and in **Appendix D**. The geometry proposed includes a central truck apron that would allow for the turning movement of tractor trailers.

Figure 9 - Airport Boulevard at Cooper Boulevard Roundabout Concept

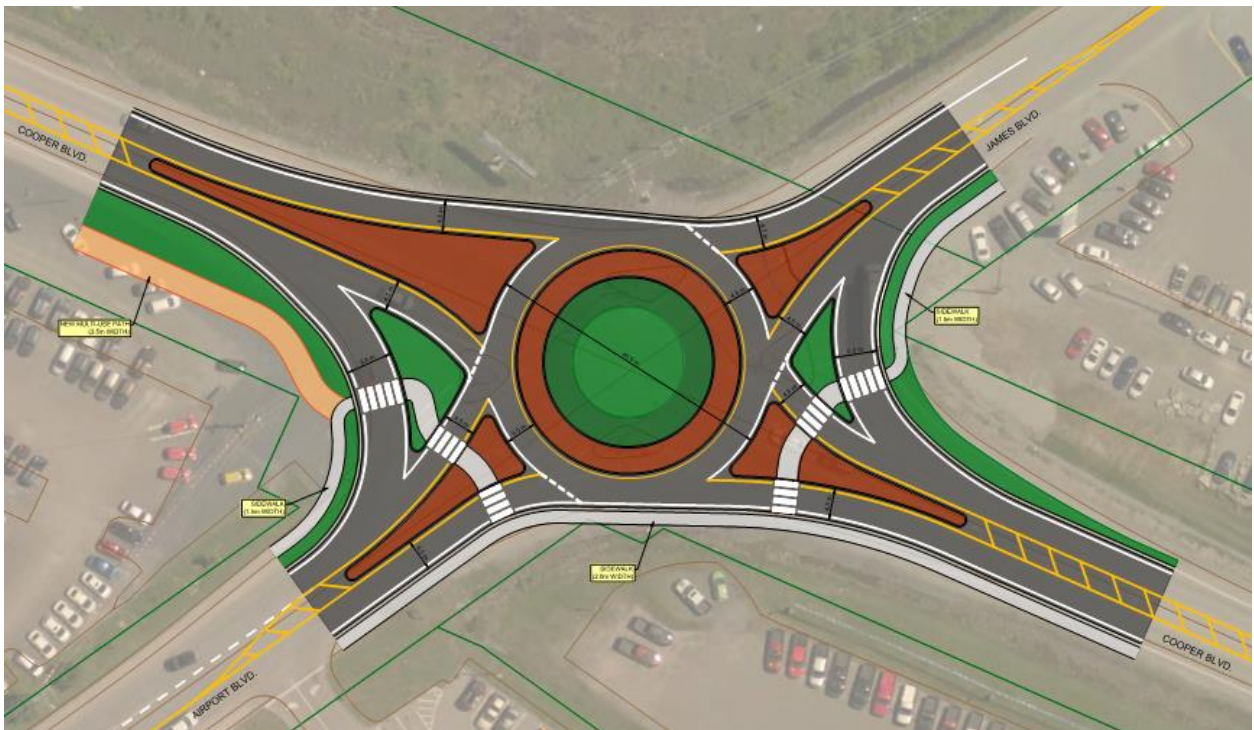

5.4 PEDESTRIAN AND CYCLING FACILITIES

Cooper Boulevard has limited pedestrian and cycling facilities. A 1.65m wide monolithic sidewalk runs along the west side of Cooper Boulevard from Edinburgh Avenue to Memorial Drive. The remaining sections of Cooper Boulevard only have gravel shoulders. A multi-use trail runs along the west Cooper Boulevard from Edinburgh Avenue to north of Raynham Avenue, but ATV's are permitted on this trail which is not compatible with active transportation uses. The existing trail and sidewalk facilities along Cooper Boulevard are summarized in **Table 10**. Pedestrian crossings on Cooper Boulevard are provided

at Raynham Avenue (with an RRFB treatment) and at the Roe Avenue and Airport Boulevard signalized intersections.

Table 10 - Location of Pedestrian and Cycling Facilities along Cooper Boulevard

Corridor Segment	West Side Facility	East Side Facility
Magee Rd to Raynham Ave (1,230m)	ATV and multi-use trail (425m)	No facility
Raynham Ave to Memorial Dr (940m)	ATV and multi-use trail	No facility
Memorial Dr to Roe Ave (508)	ATV and multi-use trail and 1.7m Sidewalk	No facility
Roe Ave to Airport Blvd (660m)	No facility	No facility
Airport Blvd to TCH 1 (1,280m)	ATV and multi-use trail (885m)	ATV and multi-use trail (200m beginning at Laurel Rd)

The following are recommended to accommodate active transportation (AT) users and improve pedestrian comfort and safety:

- Install a concrete island in the northeast corner of Cooper Boulevard/Raynham Avenue to provide more protection for pedestrians and extend sidewalks with ramps to the crosswalk on both side street approaches;
- Install a sidewalk along the east side of Cooper Boulevard between Catalina Drive and Roe Avenue (200m);
- Install a sidewalk along the west side of Cooper Boulevard between Airport Boulevard and Laurel Road to maintain pedestrian connectivity in this commercial area; and
- Upgrade the existing multi-use trail along the west side of Cooper Boulevard to an Active Transportation trail from Raynham Avenue to Edinburgh Avenue and extend the trail to Airport Boulevard. The trail should have a 3.0-3.5m width and pavement surface. The total distance of new/upgraded trail would be 2.2 km.

The proposed active transportation trail would serve as an important pedestrian and cycling facility to move people from neighbourhoods to nearby destinations by non-auto modes. The volume and speeds on Cooper Boulevard make for uncomfortable experience to walk or cycle along the shoulder. A separated facility is recommended.

ATV's are not compatible with pedestrians and cyclists. Additionally, accommodating ATV crossings at the upgraded intersections along Cooper Boulevard will be challenging and conflicts with vehicle traffic will increase as traffic volumes increase. For these reasons, ATV's should no longer be permitted along the upgrade active transportation trail and the ATV route should be diverted to another location.

5.5 ACCESS REVIEW

Numerous access points have been added along Cooper Boulevard in recent years due to ongoing development on the east side of the corridor. Two new accesses are planned, including the Penney Avenue Extension intersection, north of Raynham Drive, and the Gander Landing Collector A intersection, south of Airport Boulevard. The Penney Avenue access will be a T-intersection with stop control on the minor approach. The Collector A intersection is proposed to be restricted to a right-in/right-out only access to limit conflicts on Cooper Boulevard. Both accesses are planned to be added within a 5 year timeframe.

Any additional future accesses should be limited to be public street accesses only and be spaced at least 200m from the nearest existing access point.

As part of this Transportation Study, the Town asked that the private access to the Loblaws property be reviewed. This access intersects Cooper Boulevard 300m south of Laurel Road and was originally intended to be only for delivery vehicles. However, according to Town staff the access is being used regularly by customers as a short into the development site for those arriving from the TCH. The acute angle of the intersection presents a safety concern and traffic speeds entering the parking lot may be high. The following are recommended regarding this access:

- Place a No-Left Turn sign at the exit on Cooper Boulevard;
- Place speed humps on the entrance to the parking lot (beyond the truck loading bays) to reduce the speed of general traffic entering the parking lot.

A future acceleration lane on Cooper Boulevard for trucks entering southbound from the driveway access may be considered should trucks have difficulty entering the traffic stream in the future.

5.6 CORRIDOR OPTIONS AND IMPLEMENTATION PLAN

Two Corridor Options were developed to accommodate 10-year transportation demands. Option 1 includes signalization of Cooper Boulevard/Memorial Drive and Cooper Boulevard/Catalina Drive as well as significant upgrades to the signalized intersections of Cooper Boulevard/Roe Avenue and Cooper Boulevard/Airport Boulevard. Option 2 includes roundabouts at Cooper Boulevard/Memorial Drive, Cooper Boulevard/Roe Avenue, and Cooper Boulevard/Airport Boulevard, while signalizing Cooper Boulevard/Catalina Drive. Both options include the recommended pedestrian improvements along the corridor as well as capacity improvements at some remaining intersections.

Both proposed options would require significant capital investment and many of the improvements are only required in 10 years if development builds out on the timelines planned. In the short term, smaller improvements can be made to address existing deficiencies and recommendations.

A summarized list of the improvement options for the short term, for Corridor Option 1, and for Corridor Option 2 are compiled in **Table 11** below. Functional plan drawings for all improvements are provided in **Appendix D**.

Table 11 - Improvement Options

Intersection	Short Term Improvement	Long Term Improvement – Option 1	Long Term Improvement – Option 2
Magee Rd at Cooper Blvd	None required.	None required.	None required.
Penney Ave at Cooper Blvd	Pedestrian facility improvements (via Crandall Pedestrian Traffic Study 2018): Enhanced crosswalk markings with RA-4 signage on north leg of Cooper Blvd.	None required.	None required.
Mitchell St at Cooper Blvd	None required.	None required.	None required.
Raynham Ave/Briggs St at Cooper Blvd	Install concrete islands at northeast corner and extend sidewalks with ramps.	-Install Westbound Left Turn Lane with 100m storage. -Install Eastbound Right Turn Lane with 50m of storage.	Install same improvements as Option 1.
Memorial Dr at Cooper Blvd	None required.	-Install Traffic Signal with: -Northbound dedicated Left Turn Lane, Thru lane, and Thru/Right lane. - Southbound Left Turn lane, and Thru/Right channelized lane. - Eastbound Right Turn channelized lane (20m) and Thru/Left Turn lane. - Westbound Left Turn lane (35m) and Thru/Right channelized lane. -Begin 3 lane cross section on Cooper, south of Memorial (1 SB, 2 NB).	Install a single lane roundabout.
Roe Ave at Cooper Blvd	Optimize traffic signal timing.	Upgrade existing signalized intersection: -Expand intersection for truck turning movements. -Install Northbound dedicated Left Turn lane, Thru lane, and Thru/Right channelized lane. -Install Southbound dedicated Left Turn Lane (min. 50m of storage), Thru Lane, and Thru/Right channelized lane. -Begin 4 lane cross section on Cooper, south of Roe.	Install a roundabout with right turn bypass lane on the south leg and multilane entries on the east and north legs.
Catalina Dr at Cooper Blvd	TSWA performed every 2-3 years.	-Install Traffic Signal with: - Northbound Thru and Thru/Right lane. - Southbound Thru and Thru/Left lane. -Westbound Right Turn Lane extended to 75m.	Install same improvements as Option 1.
Airport Blvd at Cooper Blvd	Optimize traffic signal timings.	Upgrade existing signalized intersection: -Expand intersection for truck turning movements. - Add southbound right turn lane. - Add second northbound thru lane and extend northbound left turn lane -Extend Eastbound Left Turn lane to 50m storage reconfigure accesses to the McDonalds property to have one right-out access on Airport Boulevard. -Add Westbound Channelized Right Turn Lane with 100m storage. -Return to 2 lane cross-section on Cooper south of Airport Blvd.	Install a single lane roundabout with one lane approaches on Airport Blvd, and right turn bypass lanes on Cooper Blvd.
Laurel Rd at Cooper Blvd	None required.	None required.	None required.
Collector A at Cooper Blvd	Right turn in/out only access built by developer.	None required.	None required.
TCH 1 at Cooper Blvd	None required.	-Install dedicated Southbound Right Turn lane with 150m of storage.	Install same improvements as Option 1.
Active Transportation Improvements		-Construct multi-use (active transportation) pathway along the west side of Cooper Blvd from Airport Blvd to Raynham Drive (with possible future extension to Penney Avenue). -Construct sidewalk along the east side of Cooper Boulevard from Catalina Drive to Roe Avenue; -Construct sidewalk along the west side of Cooper Boulevard from Laurel Road to Airport Boulevard.	Install same improvements as Option 1.

5.7 IMPROVEMENT OPTIONS OPERATIONAL CONDITIONS



Option 1 Results



An LOS analysis was completed for Option 1 improvements in the 10-year horizon period using the traffic volumes displayed in **Figure 5**. Option 1 improves the overall traffic operations along Cooper Boulevard compared to the Do-Nothing Scenario. Notable observations from the analysis results are summarized below. Analysis results for intersections with proposed mitigation measures are provided in **Table 12**.

- The **Cooper Blvd @ Raynham Ave** intersection would operate at an overall LOS C during the AM peak hour and LOS D with 48.9 seconds of delay during the PM peak hour. During the AM peak the westbound left movements operate at LOS F with 252.8 seconds of delay and a v/c ratio of 1.26 and a 95th percentile queue length of 69.0m. During the PM peak the eastbound through/left and right turn movements operate at LOS E with 41.6 seconds of delay, the westbound left operate at LOS F with 783.9 seconds of delay, a v/c ratio of 2.20, and a 95th percentile queue length of 72.0m. The westbound shared through/right operates at LOS E with 47.0 seconds of delay and a v/c ratio of 0.34. This intersection should be monitored over time for a traffic signal warrant.
- The **Cooper Blvd @ Memorial Dr** intersection would operate at an overall LOS B during both peak hours. The southbound through/right movements operate at LOS B with 19.1 seconds of delay and a v/c ratio of 0.85 in the AM peak hour and LOS C with 23.5 seconds of delay and a v/c ratio of 0.75 in the PM peak hour.
- The **Cooper Blvd @ Roe Avenue** intersection would operate at an overall LOS B during the AM peak hour and LOS C during the PM peak hour. All individual turning movements operate at LOS D or better.
- The **Cooper Blvd @ Catalina Drive** intersection would operate at an overall LOS A during the AM peak hour and LOS B during the PM peak hour. All individual turning movements operate at LOS D or better.
- The **Cooper Blvd @ Airport Blvd** intersection will operate at an overall LOS B during the AM peak hour and LOS C during the PM peak hour. All individual turning movements operate at LOS D or better.
- The **Cooper Blvd @ Trans Canada Highway 1** intersection will operate at an overall LOS A in the AM peak hour and LOS F in the PM peak period with 155.2 seconds of delay. During the PM peak the southbound left/right movements operate at LOS F with 267.1 seconds of delay and a v/c ratio of 1.60. The southbound 95th percentile queue length is 382m. Should traffic volumes increase as expected, significant additional improvements may be required at this intersection in the long term to address delays on Cooper Blvd, such as signalization or a roundabout. This would require discussions with NL TPW.

The LOS results, including average delay, volume to capacity (v/c) ratios, and the 95th percentile queue lengths for the 10-year horizon are summarized in **Table 12**. The Synchro LOS reports are provided in **Appendix B**.

Table 12 – Future Option 1 Improvement LOS Results to Improved Intersections

Intersection			Overall LOS & Delay (sec/veh)	Turning Movement LOS											
				Average Delay (seconds per vehicle) [Volume to Capacity Ratio (v/c)] 95 th Percentile Queue (m)											
North South Street @ East West Street	Traffic Control	Time Period		Eastbound			Westbound			Northbound			Southbound		
			L ←	T ↑	R →	L ←	T ↑	R →	L ←	T ↑	R →	L ←	T ↑	R →	
Cooper Blvd @ Raynham Ave		AM Peak	LOS C 30.5	Shared	C 17.3 [0.49] 22	C 17.3 [0.49] 22	F 252.8 [1.26] 69	C 17.9 [0.14] 4	Shared	A 8.7 [0.10] 3	Free Flow [0.08]	Free Flow [0.03]	A 7.5 [0.01] <1	A 0.0 [0.29] <1	Shared
		PM Peak	LOS D 48.9	Shared	E 41.6 [0.70] 39	E 41.6 [0.70] 39	F 783.9 [2.20] 72	E 47.0 [0.34] 11	Shared	A 8.9 [0.27] 9	Free Flow [0.28]	Free Flow [0.08]	A 8.3 [0.01] <1	A 0.0 [0.18] <1	Shared
Cooper Blvd @ Memorial Dr		AM Peak	LOS B 16.2	Shared	D 39.3 [0.25] 20	B 13.5 [0.56] 21	C 34.8 [0.35] 26	C 23.0 [0.07] 9	Shared	B 16.6 [0.56] 9	A 5.4 [0.19] 17	Shared	A 3.1 [0.06] 4	B 19.1 [0.85] 161	Shared
		PM Peak	LOS B 14.1	Shared	C 30.5 [0.17] 15	A 9.7 [0.43] 17	C 21.6 [0.22] 20	B 13.3 [0.11] 12	Shared	A 9.7 [0.51] 25	A 10.0 [0.49] 87	Shared	A 5.6 [0.04] 3	C 23.5 [0.75] 104	Shared
Cooper Blvd @ Roe Ave		AM Peak	LOS B 18.1	B 19.9 [0.09] 10	D 40.5 [0.58] 48	A 3.7 [0.22] 5	C 22.6 [0.30] 23	C 30.9 [0.26] 28	A 3.2 [0.19] 5	A 9.9 [0.18] 12	B 14.4 [0.28] 33	Shared	B 10.7 [0.37] 32	B 18.5 [0.51] 83	Shared
		PM Peak	LOS C 22.9	B 19.1 [0.31] 24	D 40.9 [0.58] 47	A 0.9 [0.16] <1	C 25.4 [0.66] 63	C 30.7 [0.48] 59	A 6.0 [0.46] 19	B 13.0 [0.19] 17	C 26.7 [0.69] 100	Shared	B 16.0 [0.39] 22	C 21.3 [0.38] 51	Shared

Intersection			Overall LOS & Delay (sec/veh)	Turning Movement LOS Average Delay (seconds per vehicle) [Volume to Capacity Ratio (v/c)] 95 th Percentile Queue (m)											
				Eastbound			Westbound			Northbound			Southbound		
North South Street @ East West Street	Traffic Control	Time Period		L	T	R	L	T	R	L	T	R	L	T	R
Cooper Blvd @ Catalina Rd		AM Peak	LOS A 6.9	-	-	-	D 40.2 [0.47] 31	-	B 10.6 [0.50] 17	-	A 1.8 [0.26] 13	Shared	Shared	A 6.2 [0.58] 53	-
		PM Peak	LOS B 12.8	-	-	-	D 46.7 [0.73] 72	-	B 12.2 [0.61] 34	-	A 6.8 [0.44] 63	Shared	Shared	B 10.3 [0.60] 69	-
Cooper Blvd @ Airport Blvd		AM Peak	LOS B 19.9	C 25.7 [0.60] 52	C 30.5 [0.51] 55	Shared	B 18.6 [0.15] 13	D 39.3 [0.49] 39	A 0.0 [0.49] <1	B 10.9 [0.13] 13	C 22.8 [0.49] 82	Shared	B 12.4 [0.24] 20	C 21.6 [0.42] 73	A 3.9 [0.38] 17
		PM Peak	LOS C 28.4	D 45.6 [0.88] 93	C 32.0 [0.52] 55	Shared	C 23.2 [0.58] 50	D 54.3 [0.83] 93	A 0.2 [0.14] <1	B 13.4 [0.11] 10	D 37.5 [0.78] 127	Shared	B 18.9 [0.49] 27	C 27.4 [0.59] 103	A 4.3 [0.43] 19
Cooper Blvd @ Trans Canada Highway 1		AM Peak	LOS A 7.4	A 8.1 [0.23] 7	Free Flow [0.04]	-	-	Free Flow [0.06]	A 0.0 [0.11] <1	-	-	-	C 15.4 [0.37] 14	-	C 15.4 [0.37] 14
		PM Peak	LOS F 155.2	A 8.2 [0.25] 8	Free Flow [0.08]	-	-	Free Flow [0.06]	A 0.0 [0.12] <1	-	-	-	F 267.1 [1.60] 382	-	F 267.1 [1.60] 382

Option 2 (Roundabout) Results

Memorial Drive at Cooper Boulevard Roundabout:

A roundabout installation with one lane approaches would perform at a LOS A during the AM and PM peak hours. All approaches would operate at LOS C or better in the AM peak period and minimal queueing. All approaches would operate at LOS A in the PM peak period with minimal queueing. Delays are expected to be lower than the signalized option. VISSIM analysis results are shown in the table below. VISSIM LOS results are also provided in **Appendix B**.

Table 13 - Memorial Drive at Cooper Boulevard VISSIM LOS Results

Approach	AM Peak					PM Peak				
	Max Queue (m)	Veh Delay (s)	LOS	Int. Delay	Int. LOS	Max Queue (m)	Veh Delay (s)	LOS	Int. Delay	Int. LOS
Memorial EB	62.81	18.44	C	6.66	A	17.27	1.90	A	2.35	A
Cooper NB	33.31	2.69	A			58.15	5.08	A		
Cooper SB	125.29	1.81	A			26.90	2.05	A		
Memorial WB	11.50	5.97	A			13.42	2.33	A		

Roe Avenue at Cooper Boulevard Roundabout:

A roundabout with two lanes entering on the north leg and east leg, and a bypass turn lane on the south leg are proposed at this intersection. The roundabout would perform at a LOS B in the AM peak and LOS C in the PM peak hour. Delays are comparable to the signalized option. Arcady analysis results are shown in the table below. Arcady LOS results are also provided in **Appendix B**.

Table 14 - Roe Avenue at Cooper Boulevard Arcady LOS Results

Approach	AM Peak					PM Peak				
	95 th %ile Queue (m)	Veh Delay (s/veh)	LOS	Int. Delay	Int. LOS	95 th %ile Queue (m)	Veh Delay (s/veh)	LOS	Int. Delay	Int. LOS
Cooper NB	13	6.0	A	12.8	B	264	46.8	E	24.7	C
Cooper SB	90	18.3	C			24	8.8	A		
Roe WB	12	4.4	A			78	16.7	C		
Edinburgh EB	18	11.7	B			20	10.1	B		

Airport Boulevard at Cooper Boulevard Roundabout:

A single lane roundabout is proposed with a 40.0m inscribed diameter and a bypass right turn lane on the north and south legs on Cooper Boulevard. The roundabout would perform at a LOS A in the AM peak and LOS A in the PM peak hour. Delays are expected to be lower than the signalized option. Arcady analysis results are shown in the table below. Arcady LOS results are also provided in **Appendix B**.

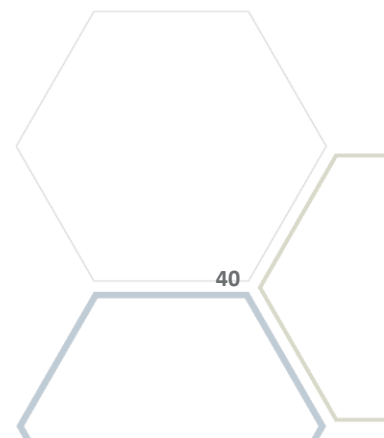

Table 15 - Airport Boulevard at Cooper Boulevard Arcady LOS Results

Approach	AM Peak					PM Peak				
	95 th %ile Queue (m)	Veh Delay (s/veh)	LOS	Int. Delay	Int. LOS	95 th %ile Queue (m)	Veh Delay (s/veh)	LOS	Int. Delay	Int. LOS
Cooper NB	8	2.6	A	4.2	A	8	2.8	A	8.0	A
Cooper SB	16	2.7	A			9	3.6	A		
James WB	9	5.6	A			74	17.3	C		
Airport EB	14	7.5	B			22	11.0	B		

In summary, the Option 2 Roundabouts result in lower overall delays than the signalized option while avoiding the need to widen Cooper Boulevard to four lanes. Further comparison of roundabouts versus traffic signals are outlined in the following section.

5.8 TRAFFIC SIGNAL VERSE ROUNDABOUT COMPARISON

A side by side comparison of a traffic signal and a roundabout options for Cooper Boulevard is provided in **Table 16**. This is a general compilation of the pros/cons for each intersection type.

Table 16 – Traffic Signal and Roundabout Comparison

TRAFFIC SIGNAL	
PROS	CONS
Traffic signals typically have lower upfront capital cost than roundabouts.	Widening of Cooper Boulevard to four lanes is required to provide long term capacity.
Traffic signal can be coordinated with adjacent signals along the corridor to optimize Cooper Boulevard traffic flow.	Signalized intersections have higher accident rates than roundabouts.
Signal timings can be optimized to adjust to traffic changes.	Traffic signals require ongoing maintenance by qualified personnel.
ROUNDABOUT	
PROS	CONS
A roundabout would result in lower overall delays at the selected intersections than traffic signals.	Greater capital cost upfront than traffic signals, although some of this difference will be offset by not needing to widen Cooper Blvd.
Single lane roundabouts are safer than traffic signals for both vehicles and pedestrians.	Driver education will be required given this would be the Town’s first roundabout.
Roundabouts have lower maintenance costs in the future than traffic signals.	
Roundabouts are a “greener” option as they result in lower fuel consumption due to idling, etc.	
Roundabouts can have a calming effect on corridor traffic speeds and can provide a “gateway” treatment to urbanized areas.	

5.9 PRELIMINARY CONSTRUCTION COST ESTIMATES

Class D construction cost estimates were prepared for the Option 1 and Option 2 infrastructure improvements. These are considered planning level estimates and include a 20% contingency. Additional assumptions made in the preparation of these estimates include:

- The Option 1 upgrades to Cooper/Memorial, Cooper/Roe, Cooper/Catalina, and Cooper/Airport included a complete asphalt resurfacing of the intersection area and approaches;
- Signal equipment would be replaced in its entirety;
- Underground sanitary and water services would not be impacted;
- Right-of-way acquisition is not included in the estimates;
- Engineering costs are not included.

A breakdown of Option 1 costs is provided in **Appendix E**. Costs for Option 2 roundabouts were based on ballpark construction costs for similar sized roundabouts from past experience.

Table 17 – Preliminary Class Construction Cost Estimates

PROJECT LOCATION	OPTION 1 ESTIMATE	OPTION 2 ESTIMATE
Cooper Boulevard/Raynham Avenue	\$30,100	\$30,100
Cooper Boulevard/Memorial Drive	\$837,800	\$760,000
Cooper Boulevard/Roe Avenue	\$915,100	\$1,000,000
Cooper Boulevard/Catalina Drive	\$737,900	\$737,900
Cooper Boulevard/Airport Boulevard	\$888,600	\$1,000,000
Cooper Boulevard/TCH	\$209,900	\$209,900
AT Trail (Airport Blvd to Raynham Ave)	\$428,000	\$428,000
Subtotal	\$4,047,400	\$4,165,900

Note: Cost estimates do not include HST

6.0 CONCLUSION

The conclusions of this Transportation Study are summarized as follows:

- Under existing traffic volumes, all intersections within the Study Area are operating efficiently overall, as characterized by acceptable levels of service and volume-to-capacity ratios.
- Significant development is planned adjacent to Cooper Boulevard within the next 10 years. If the expected build-out is reached, this development could generate more than 1,000 vehicle trips in the AM peak hour and more than 2,000 vehicle trips in the PM peak hour. This will significantly increase traffic pressures along the Cooper Boulevard corridor. Additionally, as more residential and commercial uses are added, pedestrian and cycling demands will also increase.
- Under future 2030 traffic conditions, if no infrastructure improvements are made, many operational deficiencies along the corridor can be expected, including high delays, poor levels of service, and long queues at most Study Area intersections.
- Traffic signals were found to be warranted at the Cooper Boulevard/Memorial Drive and Cooper Boulevard/Catalina Drive intersections by year 2030 (or before).
- Two Corridor Options were developed to accommodate 10-year transportation demands. Option 1 includes signalization of Cooper Boulevard at Memorial Drive and Catalina Drive as well as significant upgrades to the signalized intersections of Cooper Boulevard/Roe Avenue and Cooper Boulevard/Airport Boulevard. Option 2 includes roundabouts at Memorial Drive, Roe Avenue, and Airport Boulevard, while still signalizing Cooper Boulevard/Catalina Drive. Both options include pedestrian improvements along the corridor as well as capacity improvements at some remaining intersections.
- Under both Corridor Options, all Study Area intersections would operate at LOS D or better during AM and PM peak hours, with exception of the Cooper Boulevard/TCH intersection which would still operate at LOS F in the PM peak hour. This intersection should be monitored over time and further improvements considered in consultation with NL TPW, when required.
- The Option 2 roundabouts are expected to operate with lower delays than the signalized conditions. Roundabouts are also safer than traffic signals for vehicles and pedestrians and can have a “calming” effect on a corridor when placed in series. Although roundabouts typically have higher upfront capital costs than traffic signals, this is offset by savings in delays and collisions and lower long-term maintenance requirements.
- Planning level construction cost estimates were prepared. It is estimated that Option 1 would cost \$4.05 million to implement while Option 2 would cost \$4.17 million (excluding engineering costs, right-of-way, and HST).
- Option 2, although slightly higher in cost, provides the best operational and safety performance over the longer term, and therefore is the recommended option.
- It is recommended that the Town proceed with short term improvement options listed and advance preliminary design and right-of-way acquisition for the major intersection upgrades listed in Option 2.

- Included in Option 2 is a 2.15 km long active transportation trail along the west side of Cooper Boulevard from Airport Boulevard to Raynham Drive. This trail would replace the existing ATV trail. Since ATV's are not compatible with pedestrians and cyclists and ATV crossings at the upgraded intersections would increase conflicts with vehicle traffic, ATV's should no longer be permitted along the upgraded active transportation trail. The ATV route should be diverted to another location.

APPENDIX A – TRAFFIC COUNTS

Traffic Count Summary

Traffic Movement Counts

Intersection: Cooper Blvd at Magee Rd
 Date: 12-03-19
 Time: 7:30 to 9:30

Sheet number: TOTALS

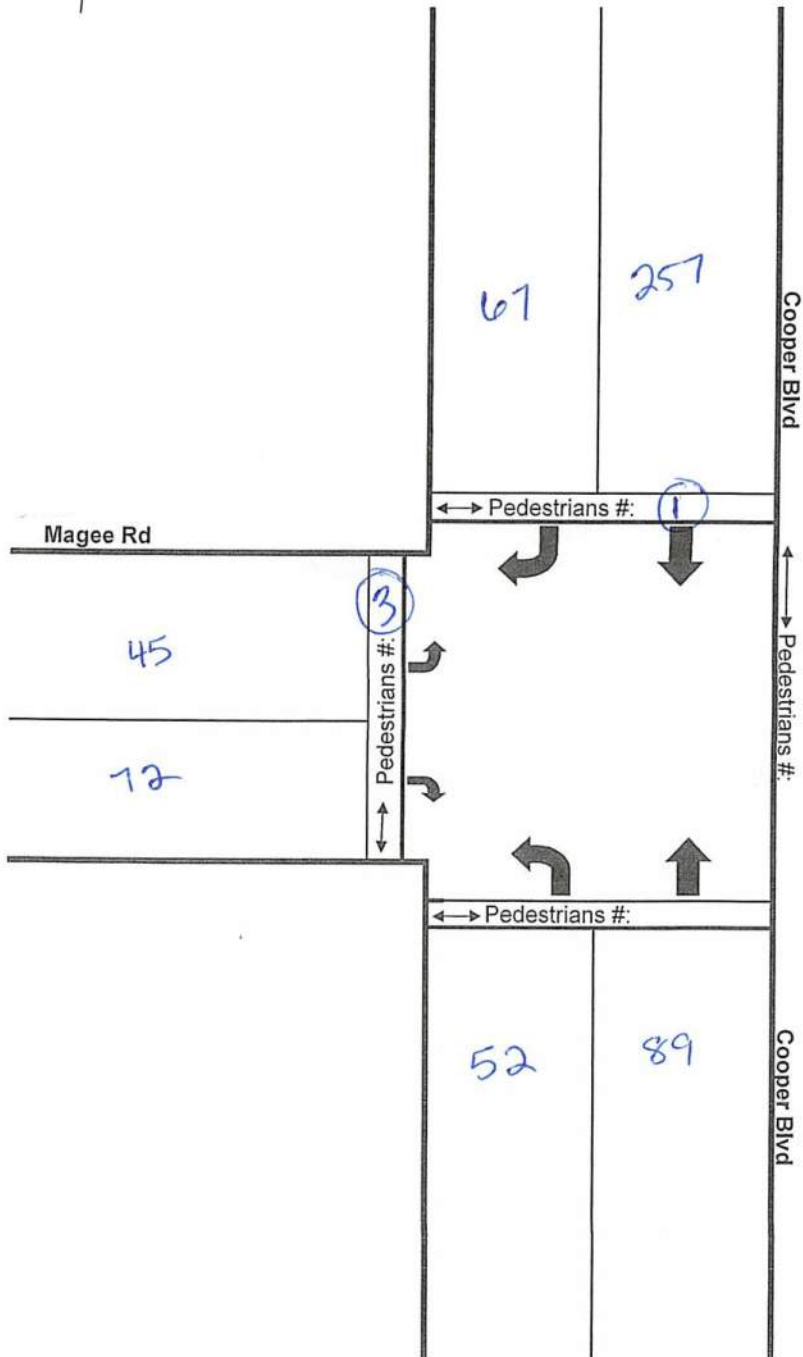

Traffic Count Summary

Traffic Movement Counts

Intersection: Cooper Blvd at Magee Rd
 Date: 12-03-19
 Time: 11:30 am to 1:30 pm

Sheet number: TOTALS

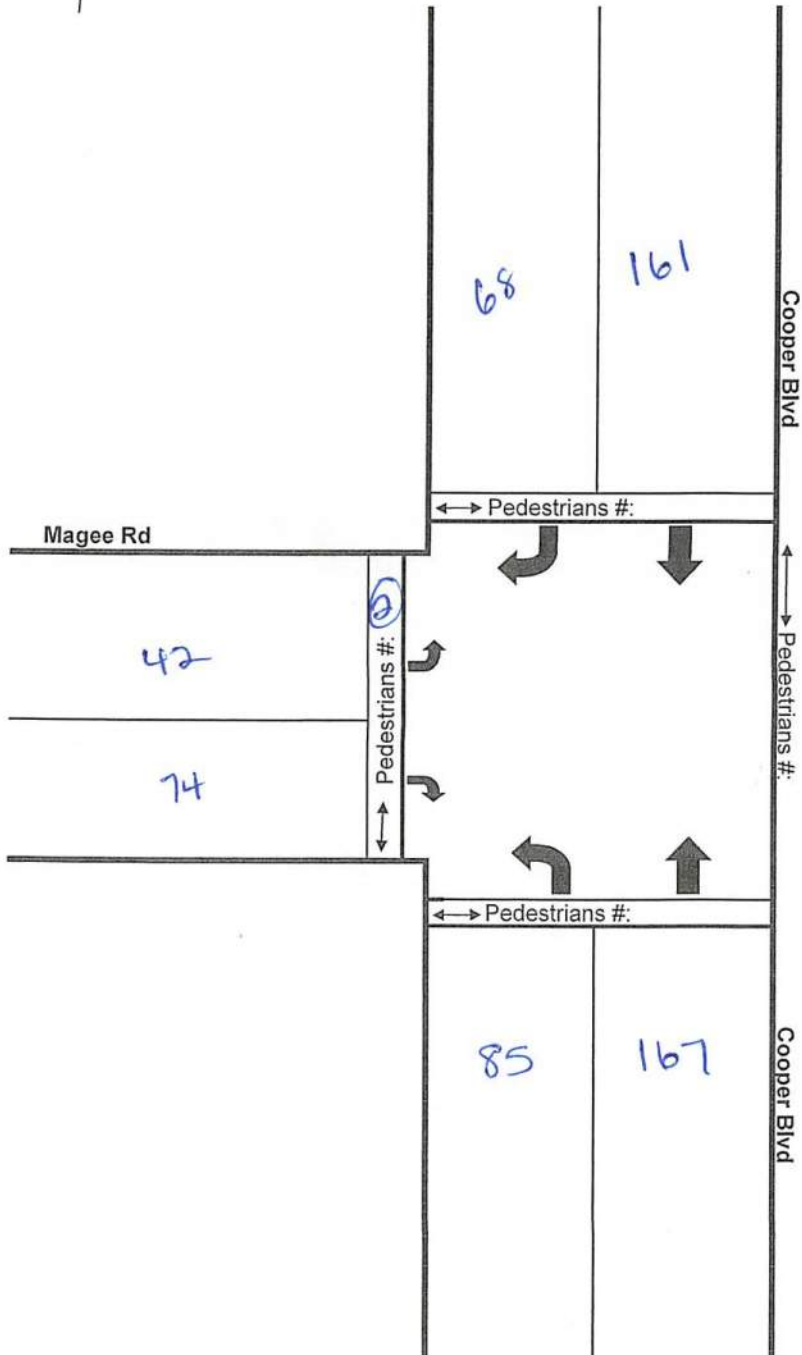

Traffic Count Summary

Traffic Movement Counts

Intersection: Cooper Blvd at Magee Rd
 Date: 12-03-19
 Time: 4:00 pm to 6:00 pm

Sheet number: TOTALS

Craig
Not totalled

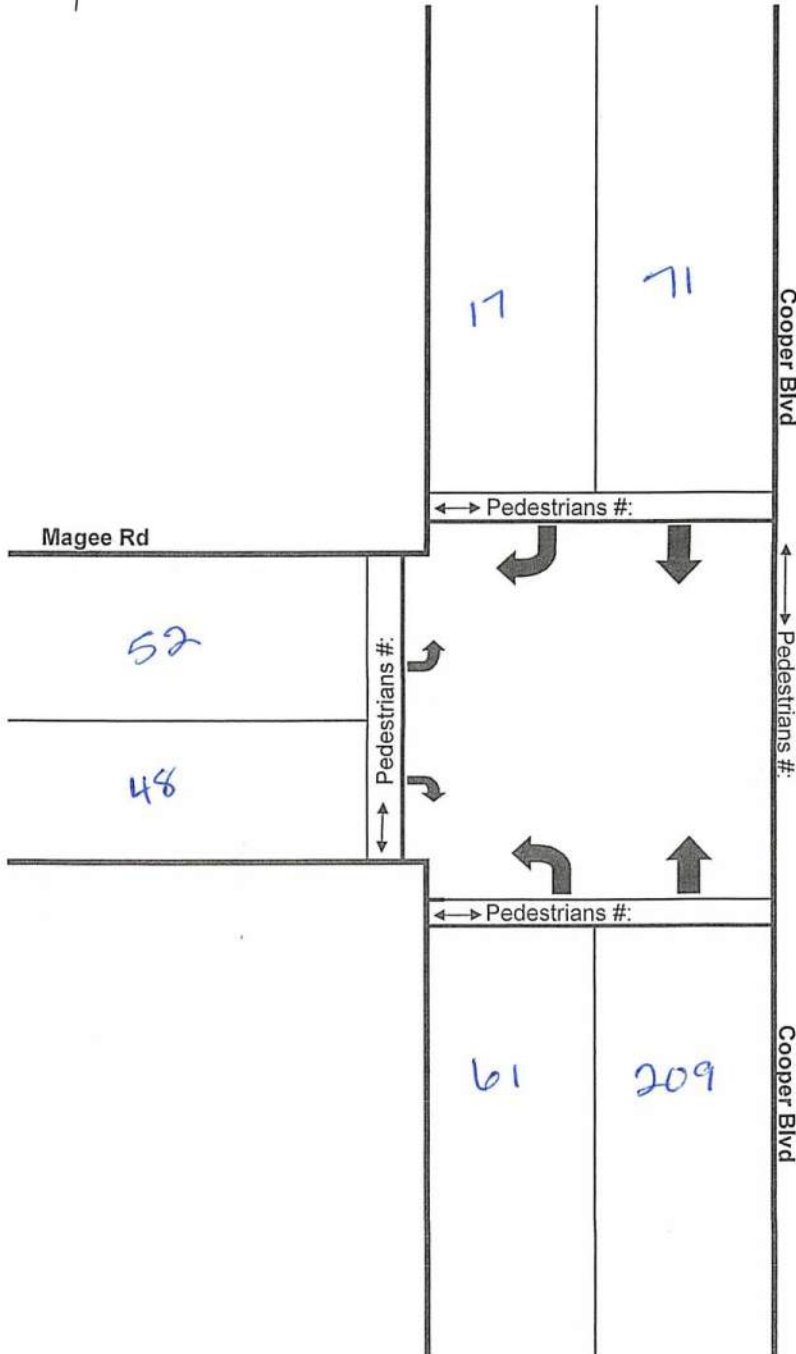

Traffic Count Summary

Traffic Movement Counts

Intersection: Cooper Blvd at Mitchell Rd
 Date: 12-03-19
 Time: 7:30 to 9:30

Sheet number: TOTALS

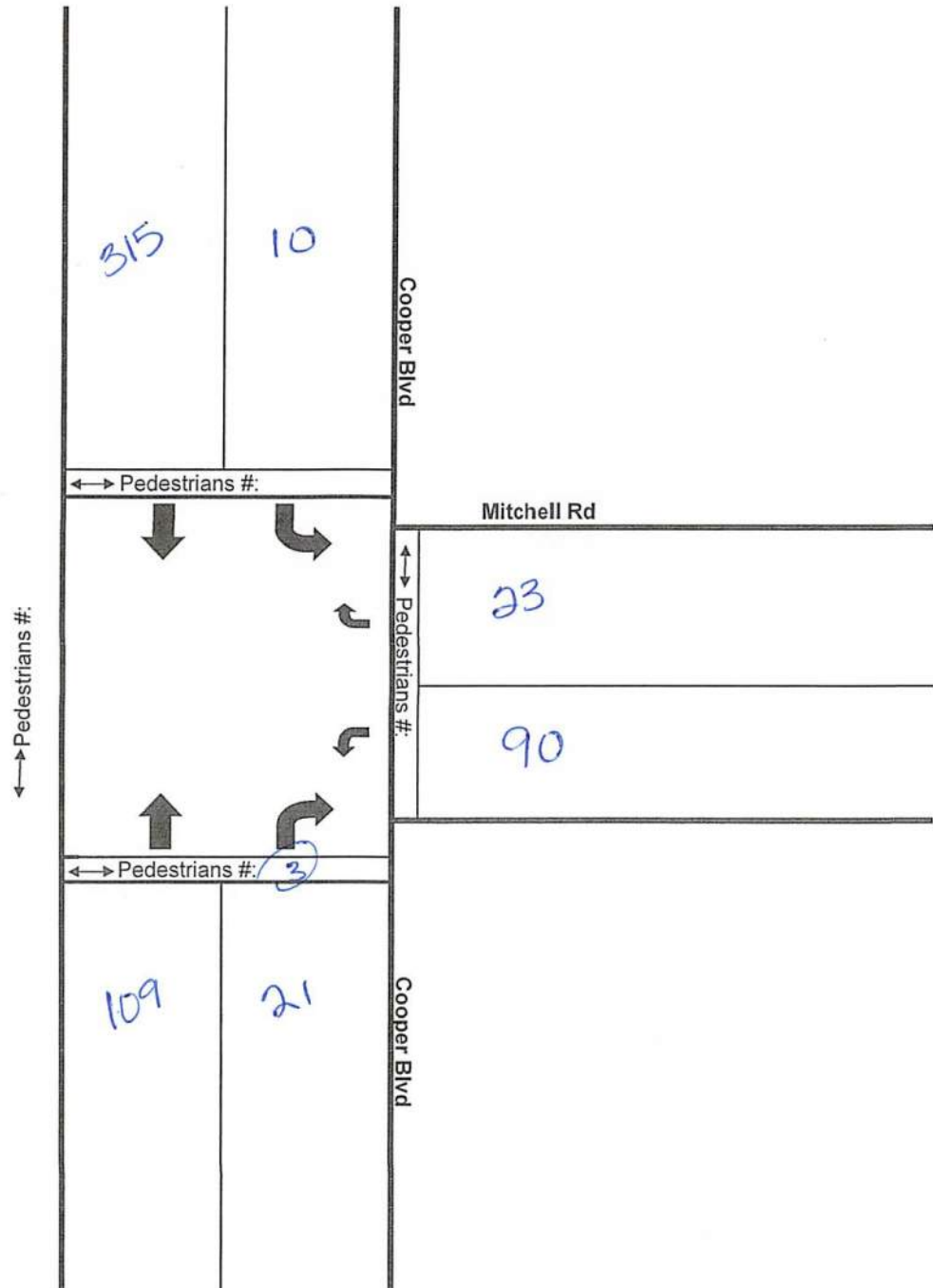

Traffic Count Summary Traffic Movement Counts

Intersection: Cooper Blvd at Mitchell Rd
 Date: 12-03-19
 Time: 11:30 am to 1:30 pm

Sheet number: TOTALS

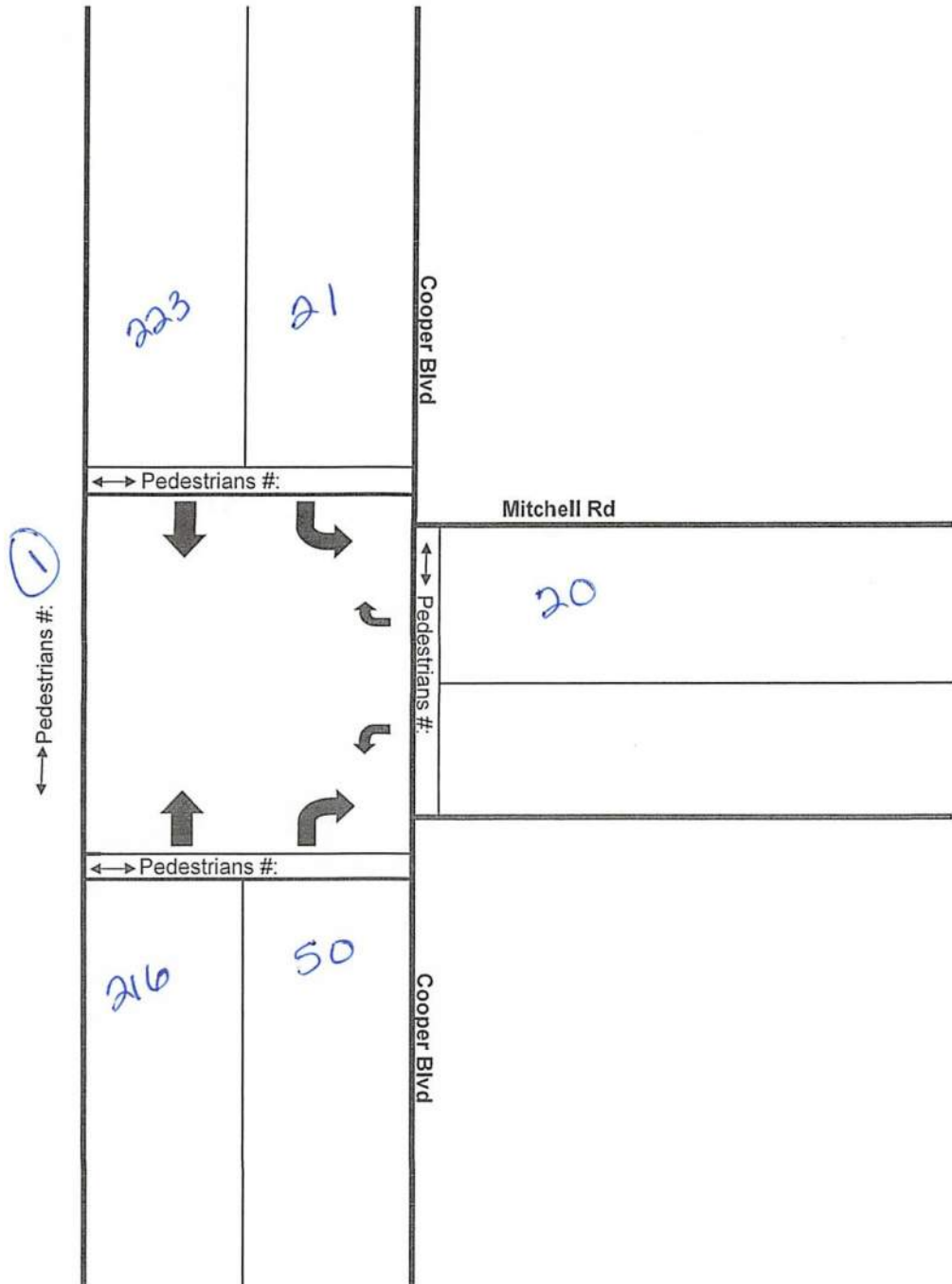

Traffic Count Summary Traffic Movement Counts



Intersection: Cooper Blvd at Mitchell Rd
 Date: 12-03-19
 Time: 4:00 to 6:00

Sheet number: TOTALS

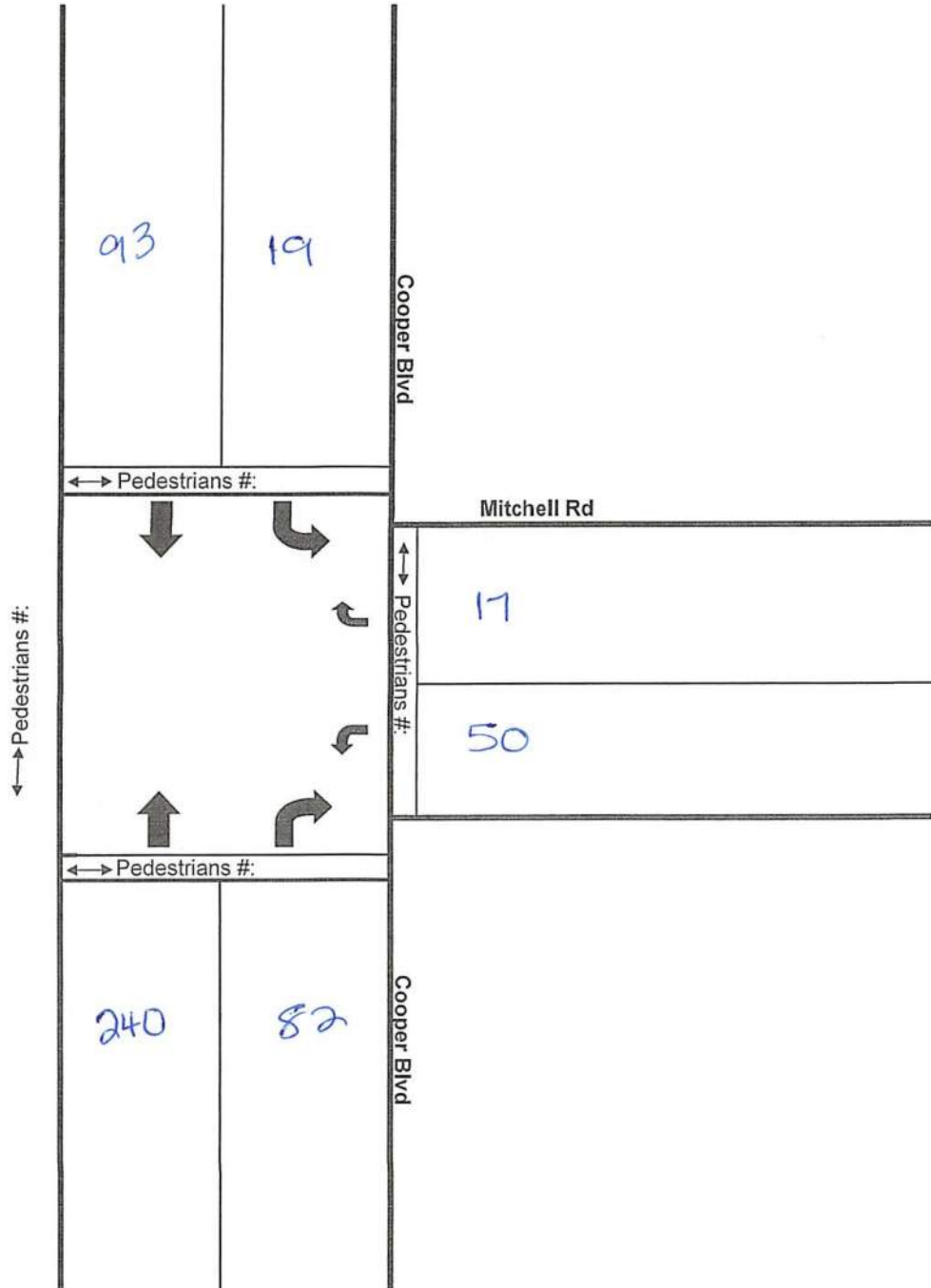

Traffic Count Summary Traffic Movement Counts



Intersection: Cooper Blvd at Roe Ave (northbound/westbound only)

Sheet number: TOTALS

Date: 12-04-19

Time: 7:30 to 9:30

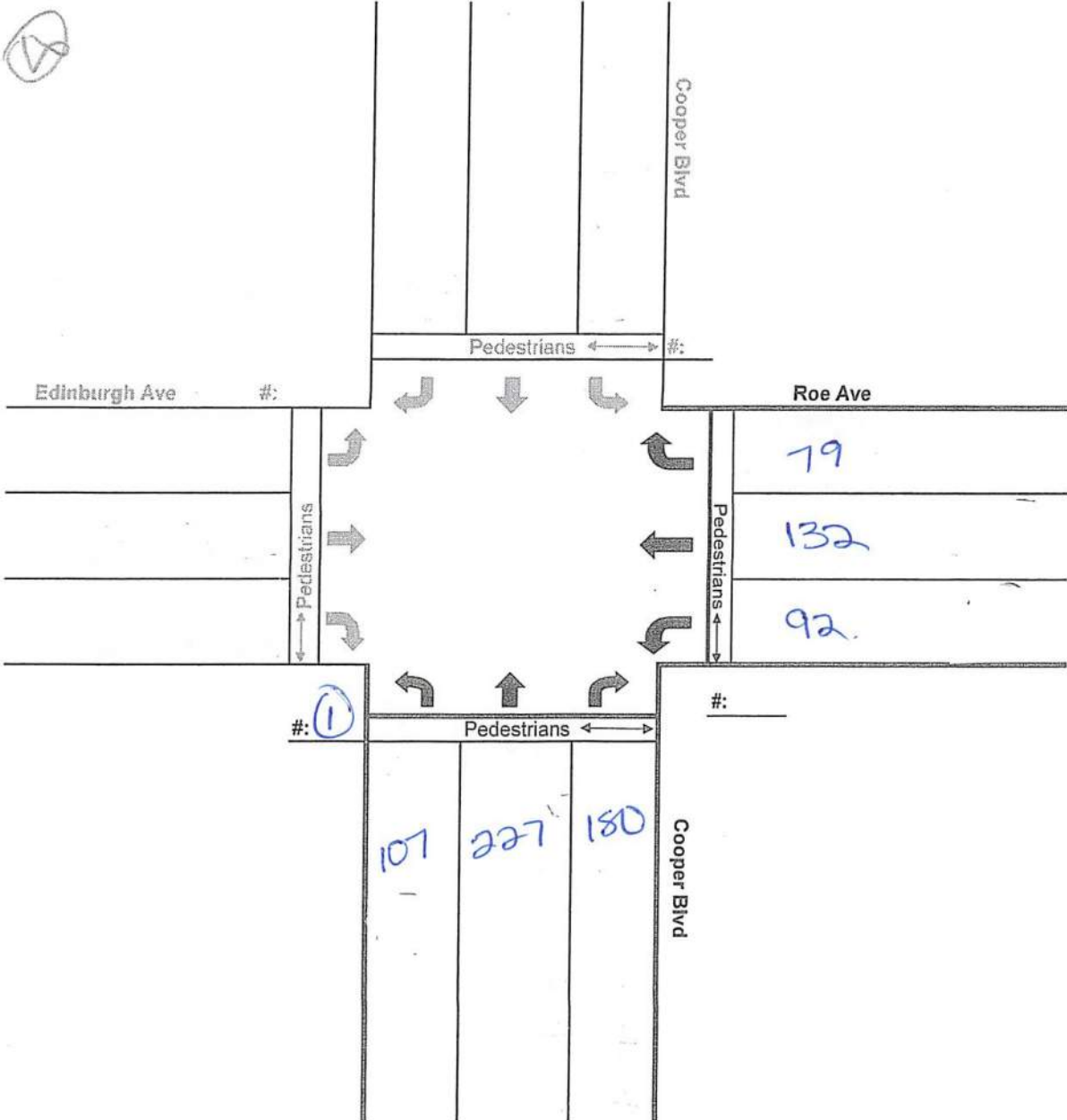

Traffic Count Summary Traffic Movement Counts



Intersection: Cooper Blvd at Roe Ave (northbound/westbound only)

Date: 12-04-19
Time: 11:30 to 1:30

Sheet number: TOTALS

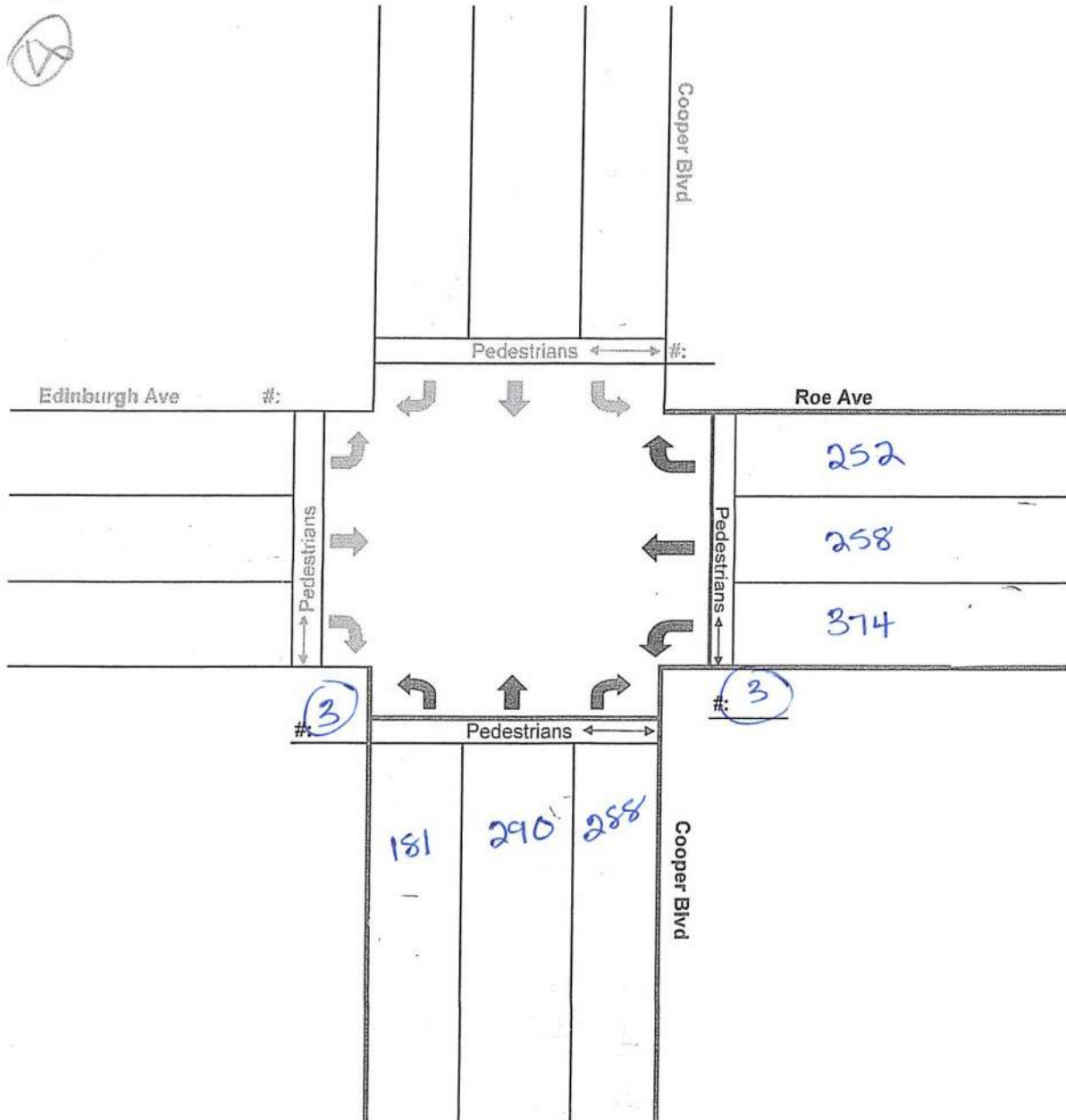

Traffic Count Summary Traffic Movement Counts



Intersection: Cooper Blvd at Roe Ave (northbound/westbound only)

Date: 12-04-19

Time: 4:00 to 6:00

Sheet number: TOTALS

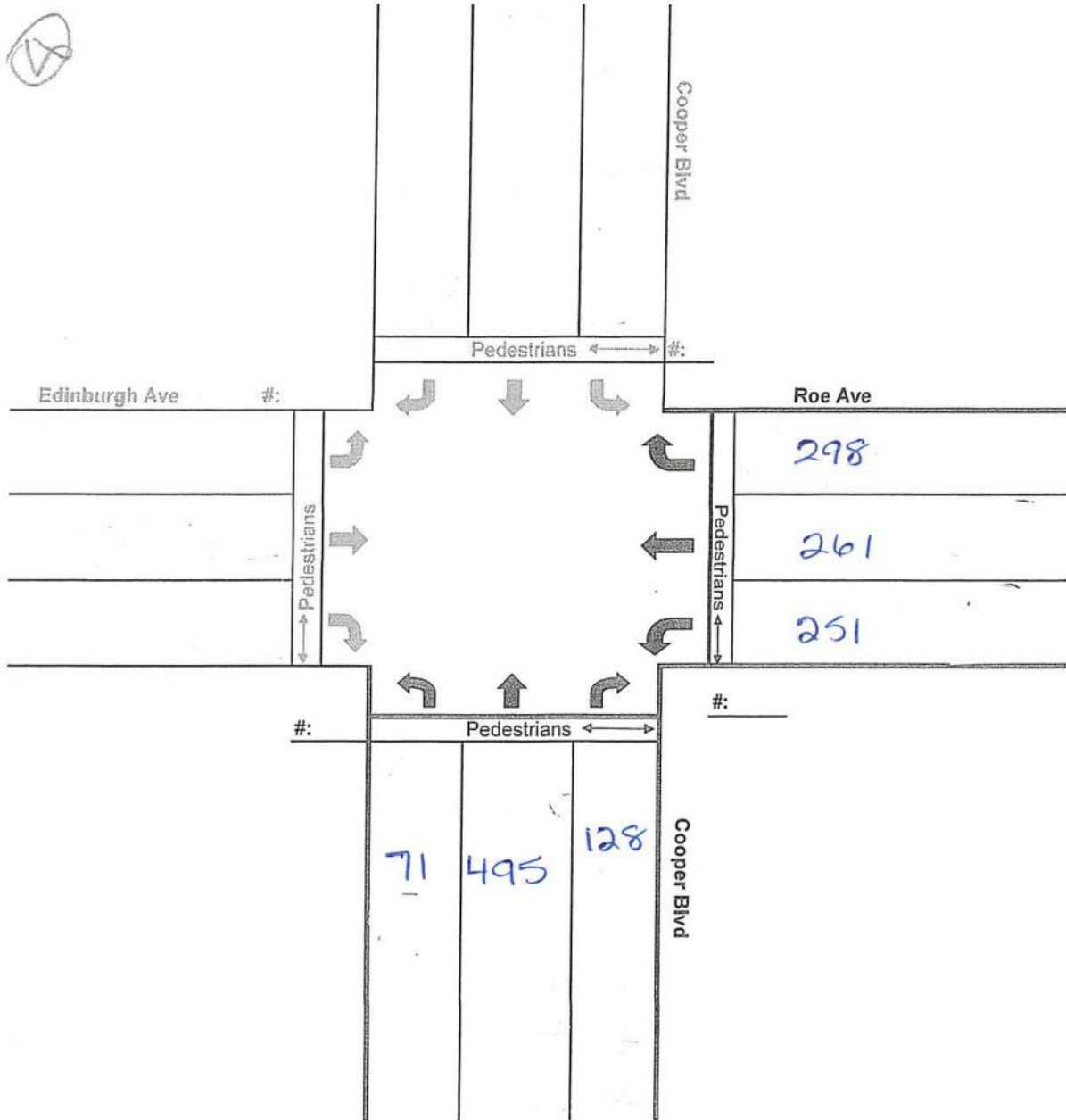

Traffic Count Summary

Traffic Movement Counts



Intersection: Cooper Blvd at Roe Ave (eastbound/southbound only) *Paviment*

Sheet number: TOTALS

Date: 12-04-19
 Time: 7:30 am to 9:30 am

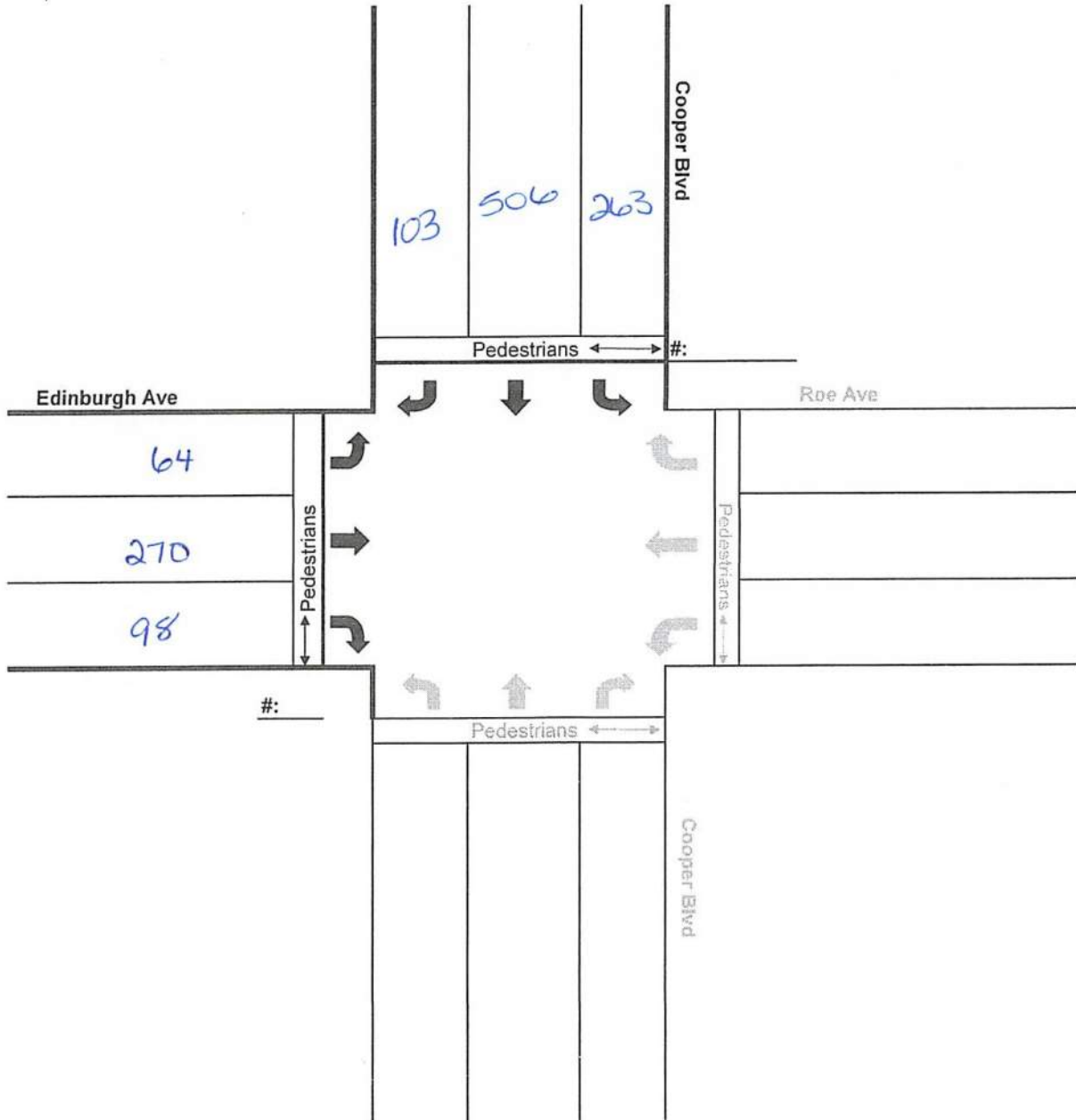

Traffic Count Summary Traffic Movement Counts



Intersection: Cooper Blvd at Roe Ave (eastbound/southbound only)

Sheet number: TOTALS

Date: 12-04-19
Time: 11:30am to 1:30pm

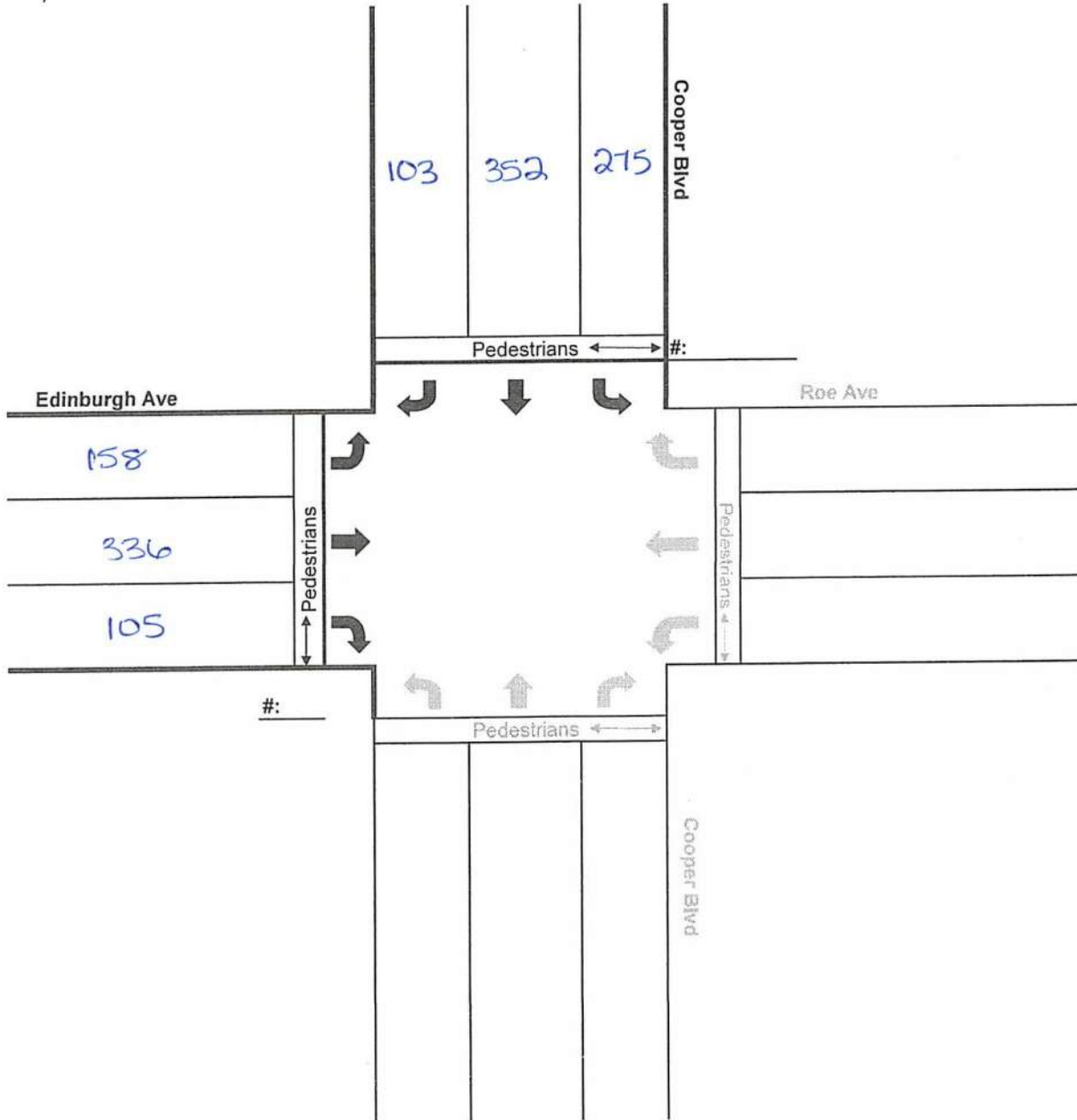

Traffic Count Summary

Traffic Movement Counts



Intersection: Cooper Blvd at Roe Ave (eastbound/southbound only)

Sheet number: TOTALS

Date: 12-04-19
 Time: 4:00pm to 6:00pm

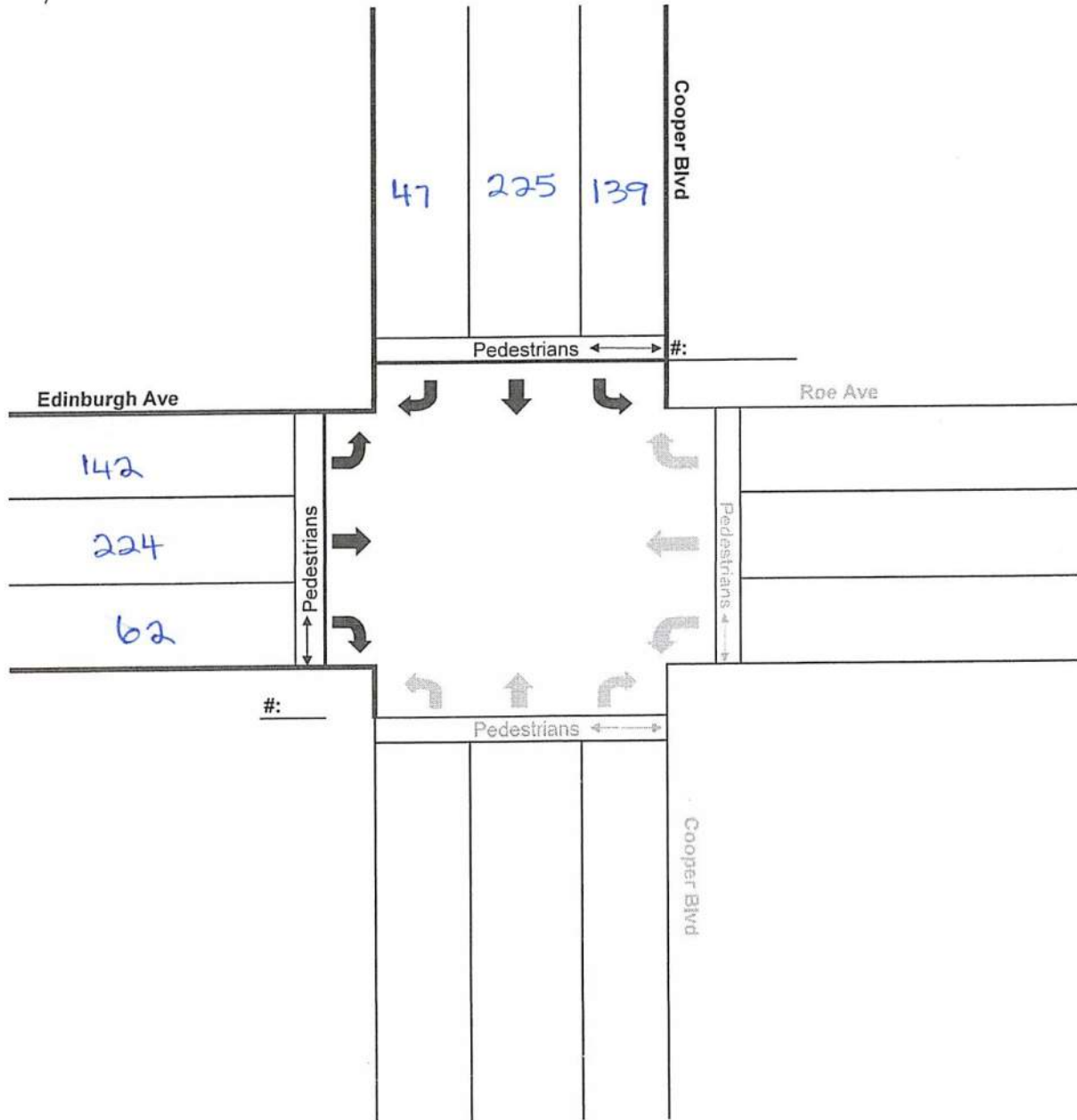

Traffic Count Summary

Traffic Movement Counts

Intersection: Cooper Blvd at Catalina Rd Jodean
 Date: Dec 3, 2019
 Time: 7:30am to 9:30am

Sheet number: Totals

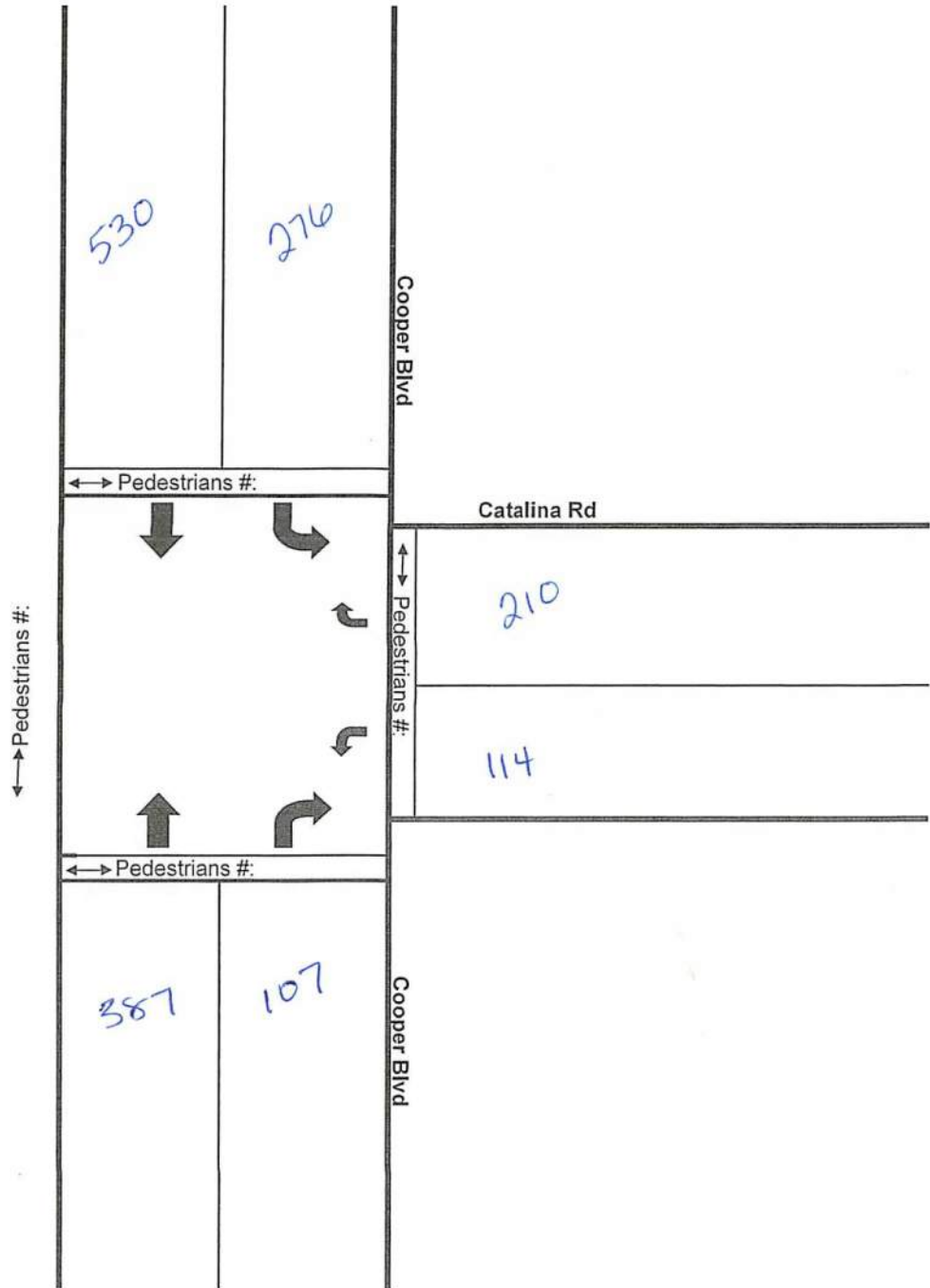

Traffic Count Summary

Traffic Movement Counts

Intersection: Cooper Blvd at Catalina Rd Craig
 Date: 12-03-19
 Time: 11:30 am to 1:30 pm

Sheet number: Totals

Not totaled

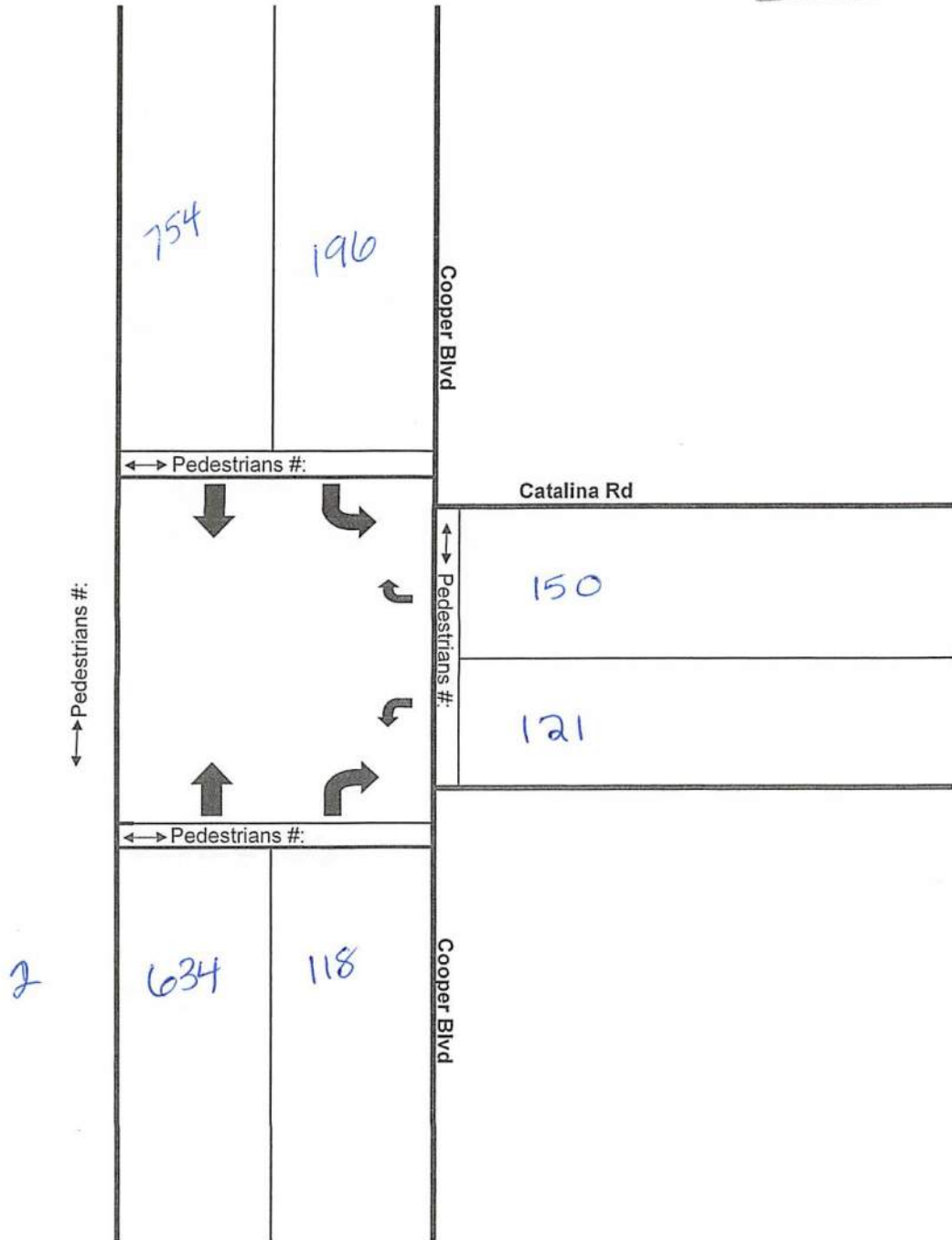

Traffic Count Summary

Traffic Movement Counts

Intersection: Cooper Blvd at Catalina Rd 10dean
 Date: 12-03-19
 Time: 4:00pm to 6:00pm

Sheet number: Totals

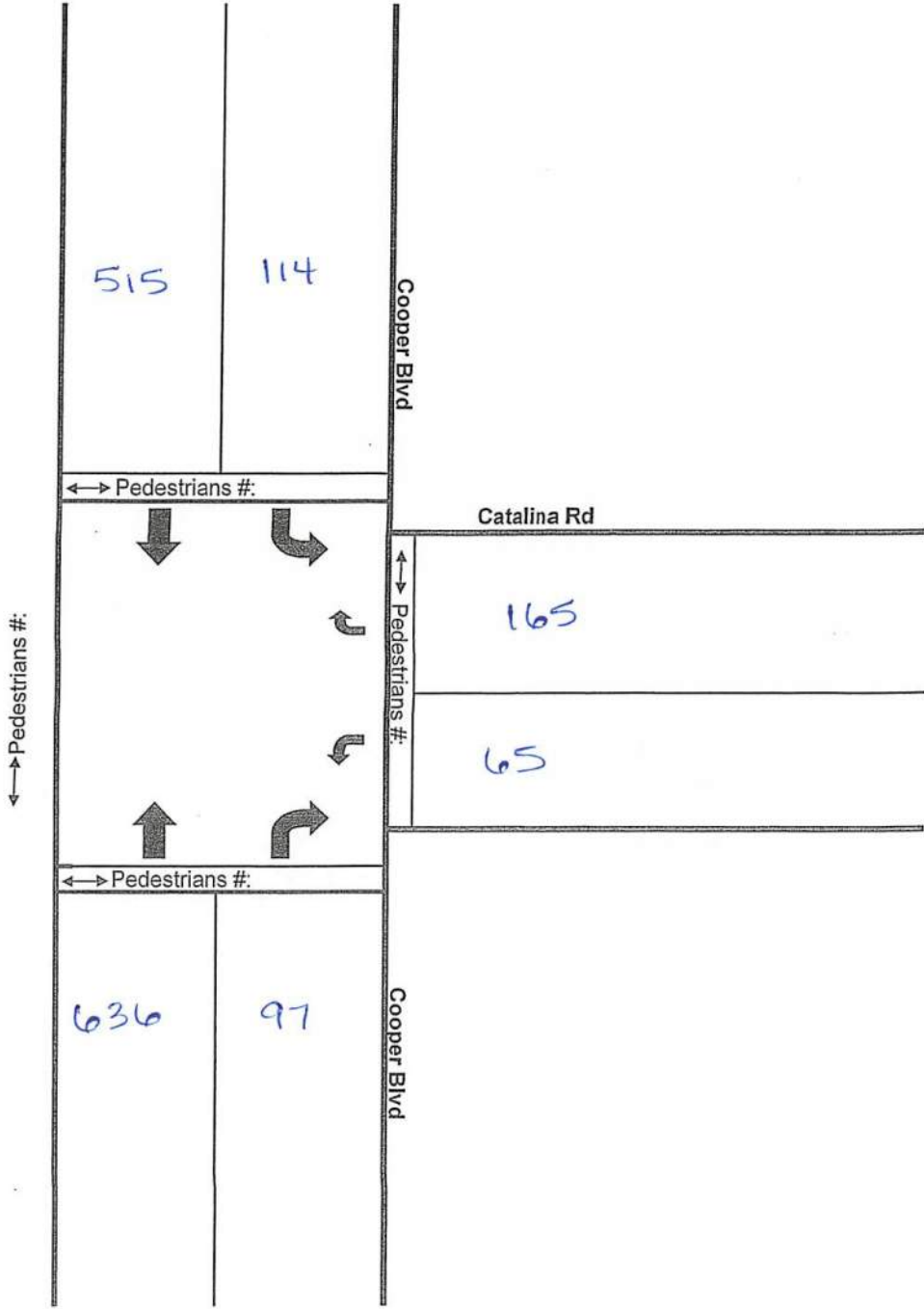

Traffic Count Summary

Traffic Movement Counts



Intersection: Cooper Blvd at Airport Blvd (northbound/westbound only)

Sheet number: TOTALS

Date: 03 Dec 4, 2019
 Time: 7:30am to 9:30am

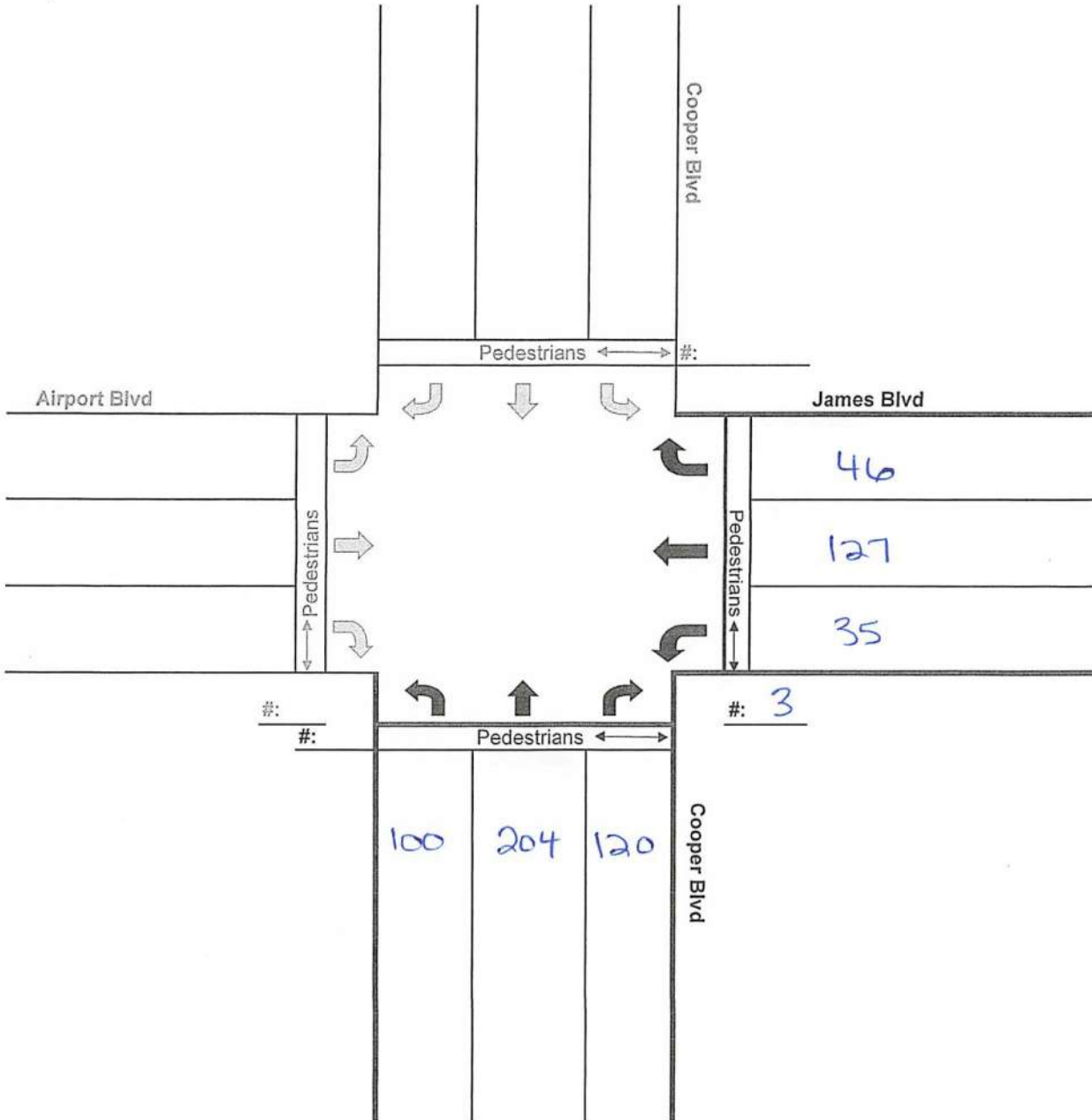

Traffic Count Summary Traffic Movement Counts



Intersection: Cooper Blvd at Airport Blvd (northbound/westbound only)

Sheet number: TOTALS

Date: Dec 3 / 2019
Time: 11:30 to 1:30

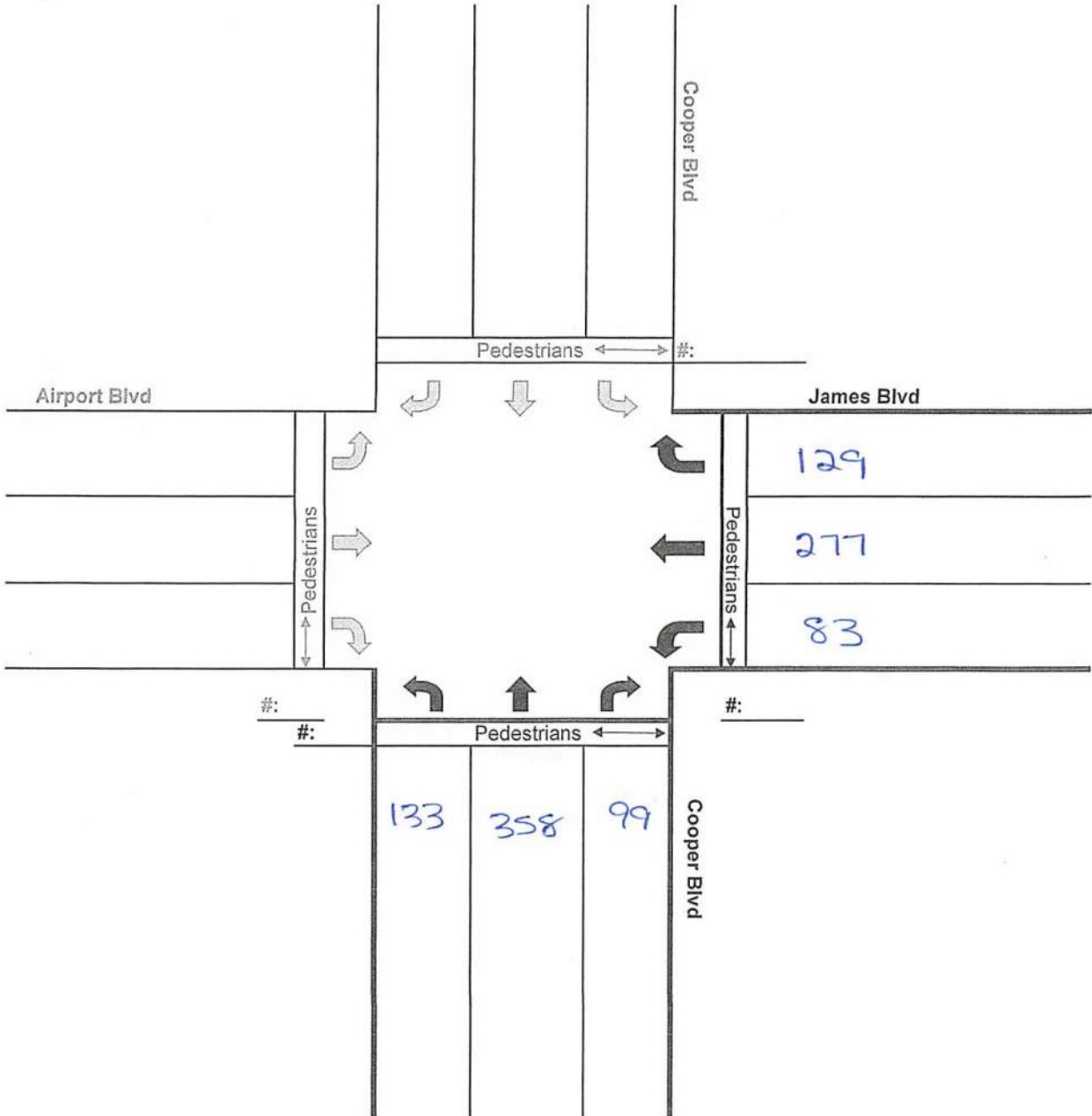

Traffic Count Summary Traffic Movement Counts



Intersection: Cooper Blvd at Airport Blvd (northbound/westbound only)

Sheet number: TOTALS

Date: Dec. 3 / 2019
Time: 4:00 to 6:00

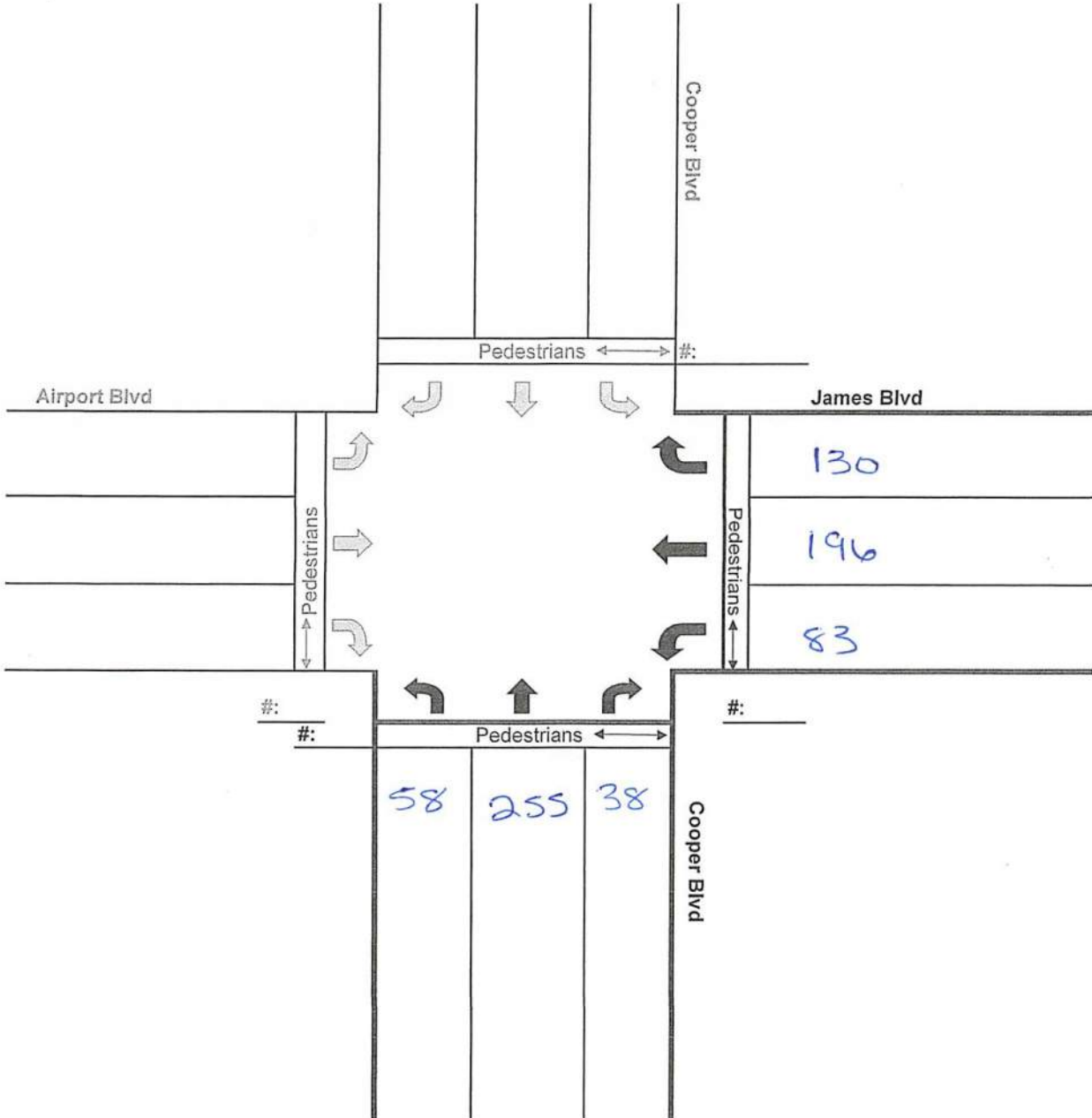

Traffic Count Summary Traffic Movement Counts



Intersection: Cooper Blvd at Airport Blvd (eastbound/southbound only)

Sheet number: TOTALS

Date: 12-03-19
Time: 7:30am to 9:30am

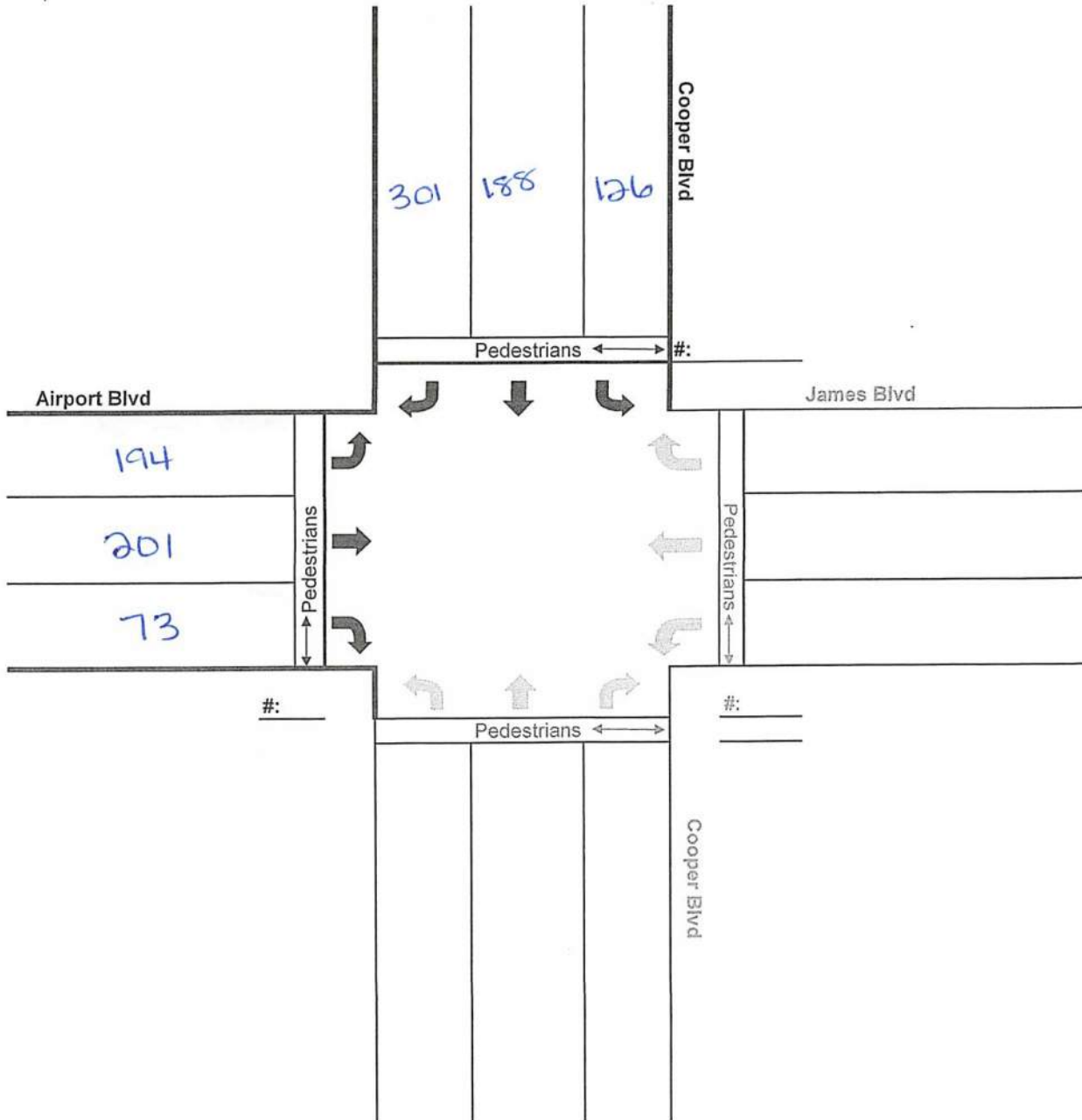

Traffic Count Summary Traffic Movement Counts



Intersection: Cooper Blvd at Airport Blvd (eastbound/southbound only)

Sheet number: TOTALS

Date: 12-03-19

Time: 11:30 am to 1:30 pm

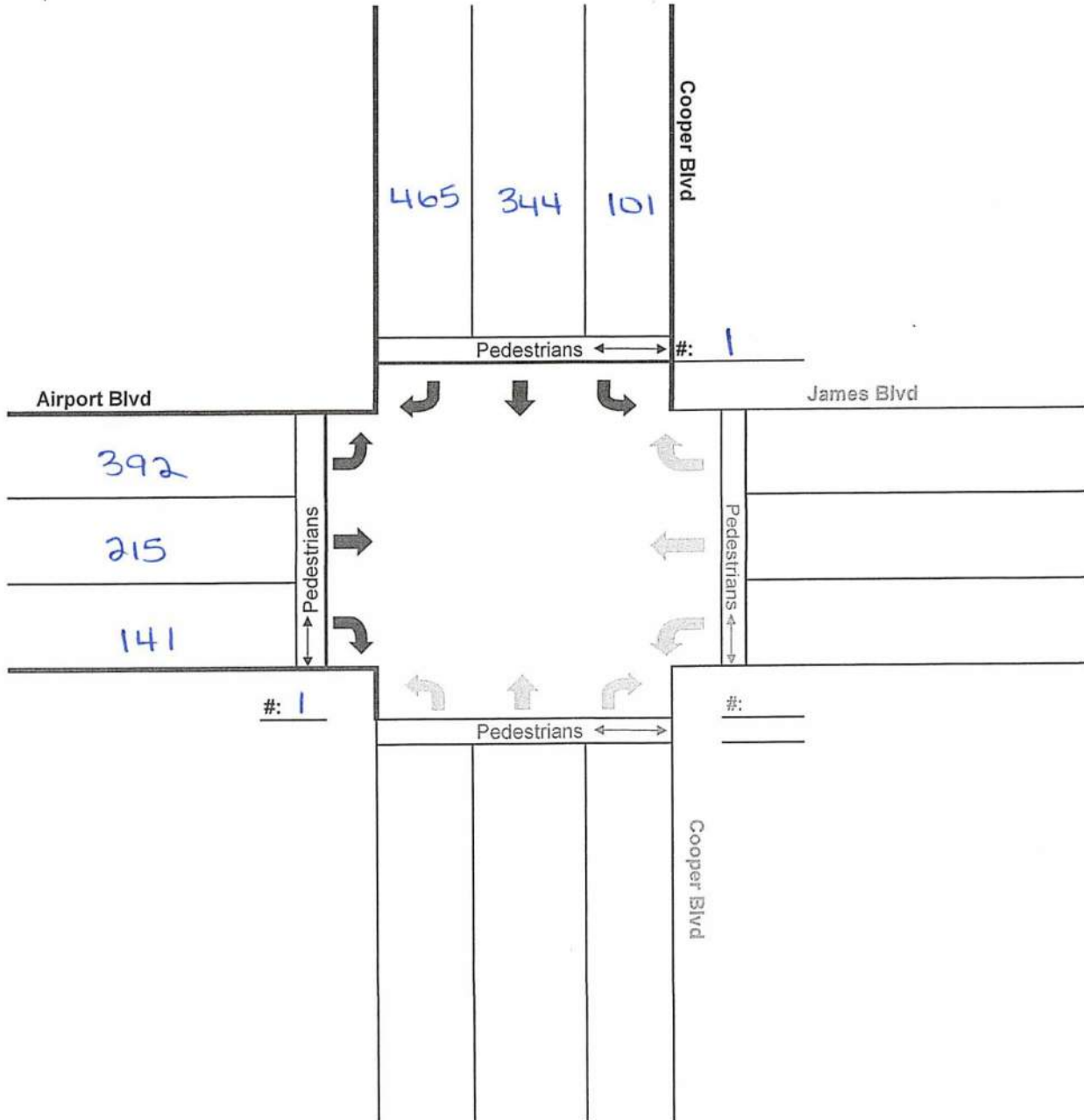

Traffic Count Summary Traffic Movement Counts



Intersection: Cooper Blvd at Airport Blvd (eastbound/southbound only)

Sheet number: TOTALS

Date: 12-03-19

Time: 4:00pm to 6:00pm

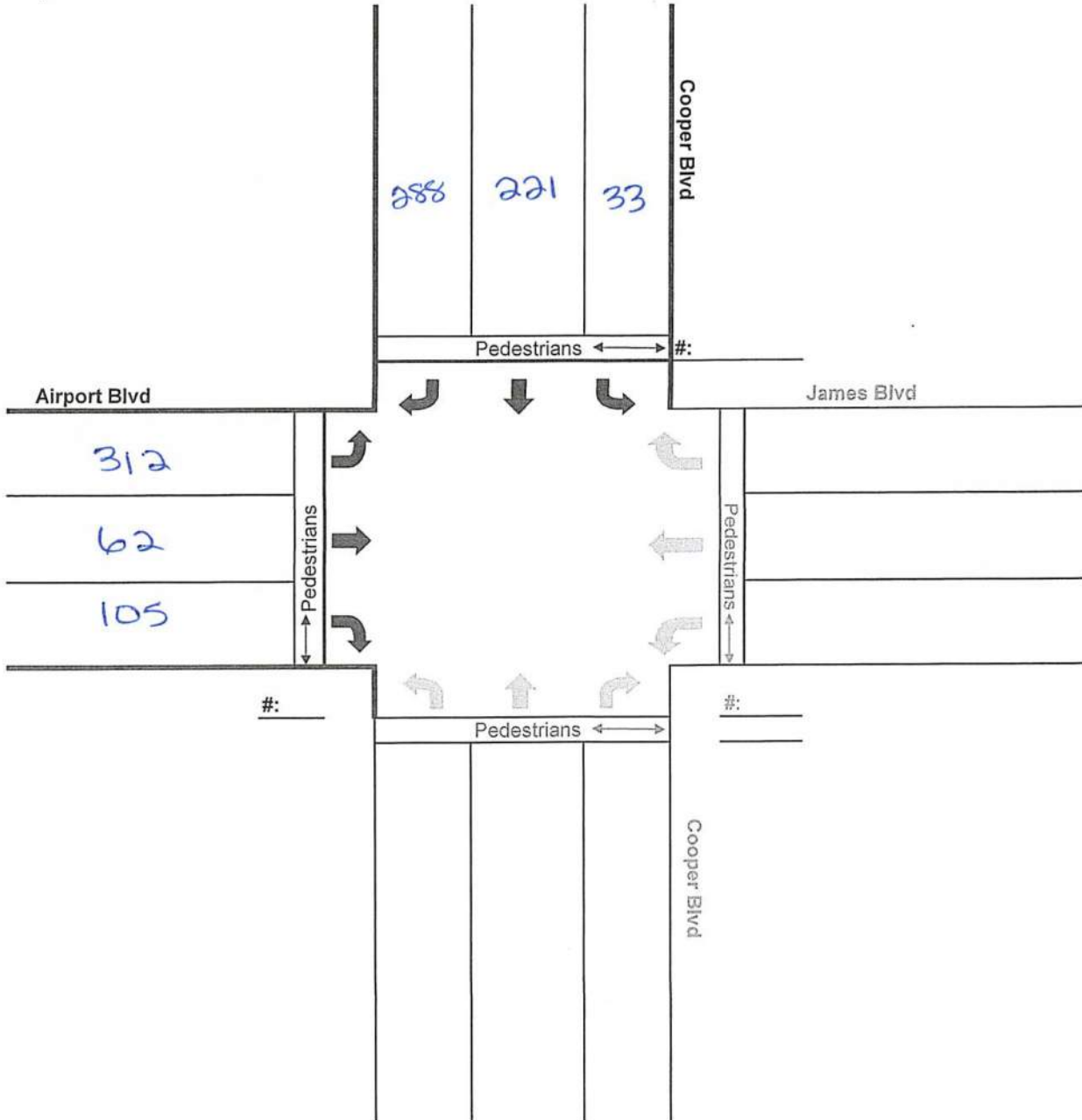

Traffic Count Summary

Traffic Movement Counts



Intersection: Cooper Blvd at Laurel Rd
 Date: Dec 4, 2019
 Time: 7:30 am to 9:30 am

Sheet number: Totals

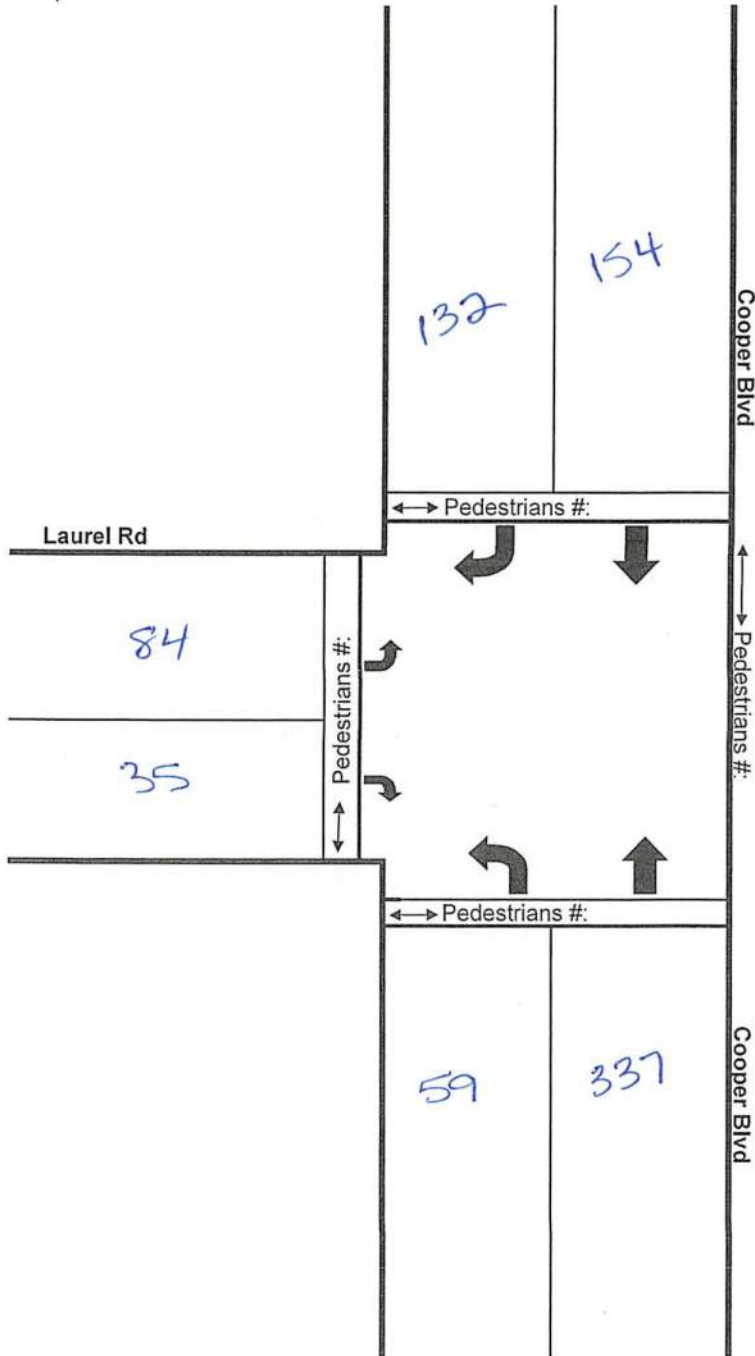

Traffic Count Summary

Traffic Movement Counts



Intersection: Cooper Blvd at Laurel Rd
Date: Dec 4, 2019
Time: 11:30 am to 1:30 pm

Sheet number: Totals

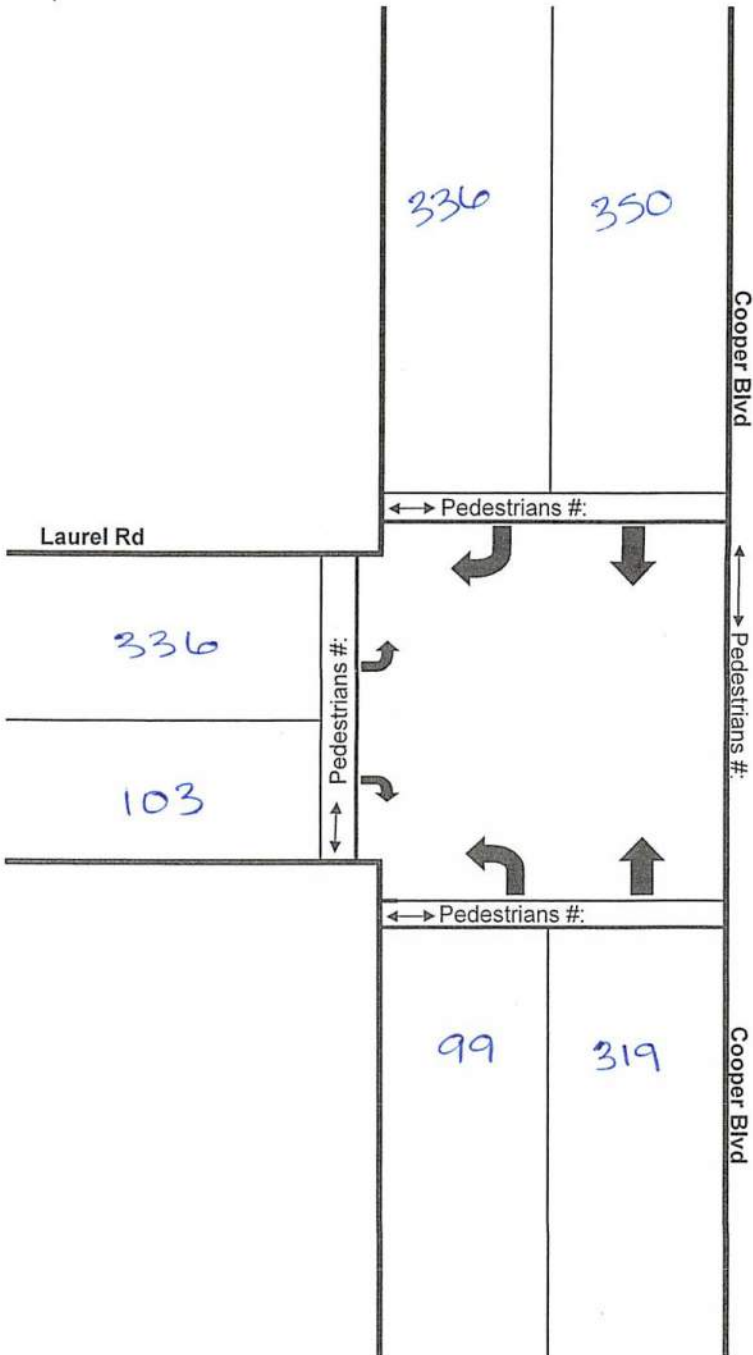

Traffic Count Summary

Traffic Movement Counts



Intersection: Cooper Blvd at Laurel Rd
 Date: Dec 4, 2019
 Time: 4:00pm to 6:00pm

Sheet number: Totals

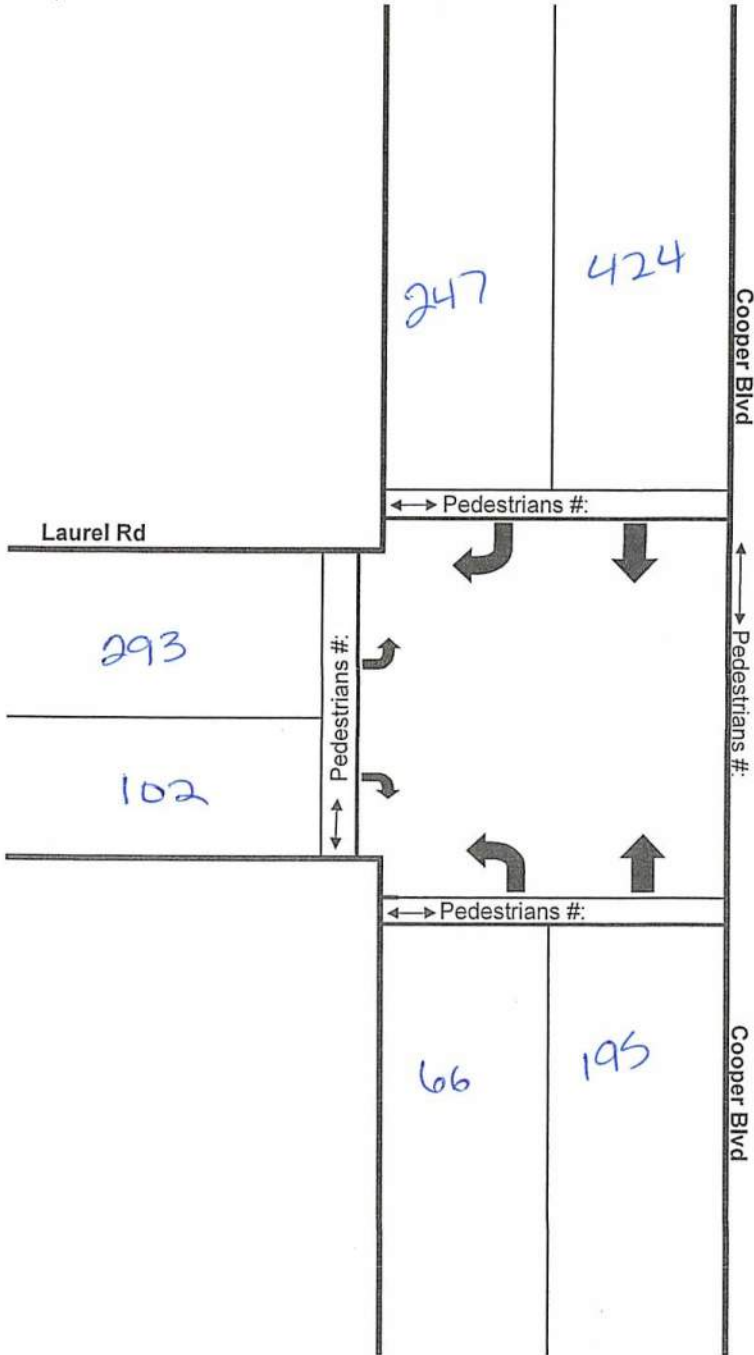

Traffic Count Summary

Traffic Movement Counts



Intersection: Cooper Blvd at TCH1 Jodean Marsh
 Date: Dec. 4, 2019
 Time: 7:30 am to 9:30 am

Sheet number: Totals

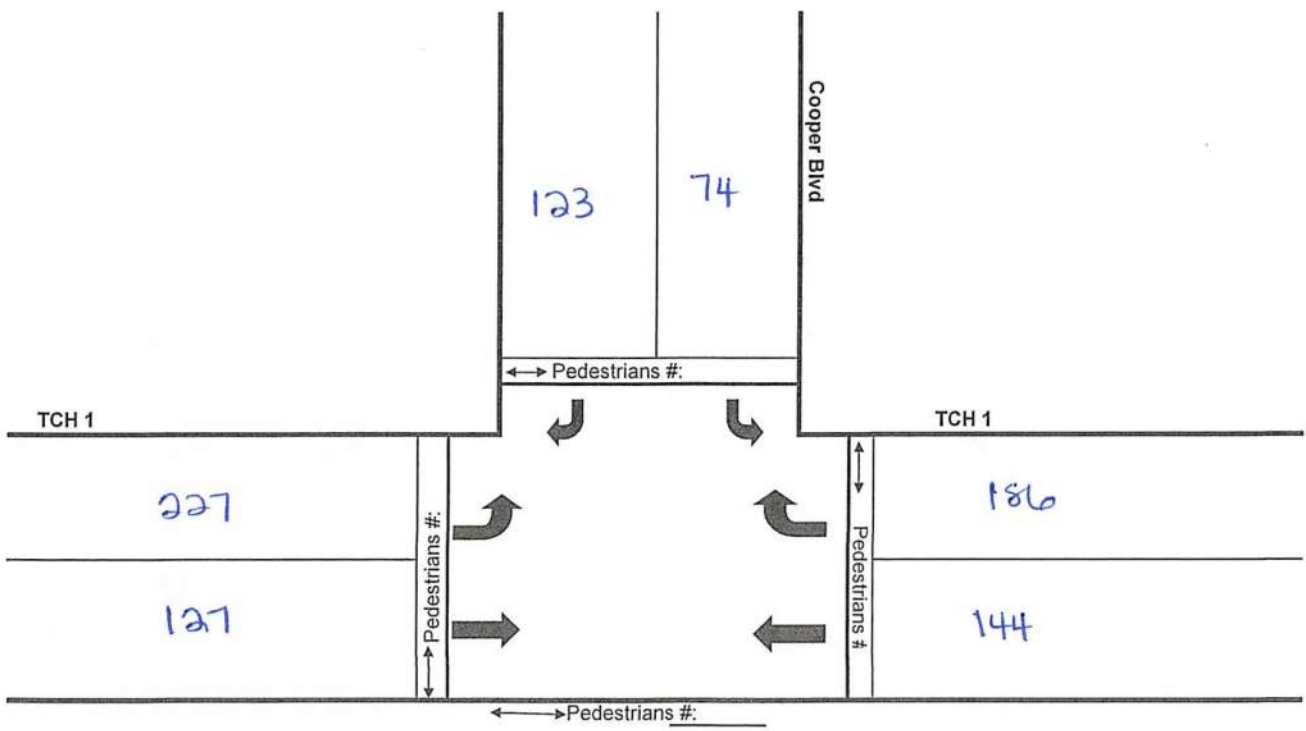

Traffic Count Summary

Traffic Movement Counts



Intersection: Cooper Blvd at TCH1 Jodean marsh
 Date: Dec. 4, 2019
 Time: 11:30am to 1:30pm

Sheet number: Totals

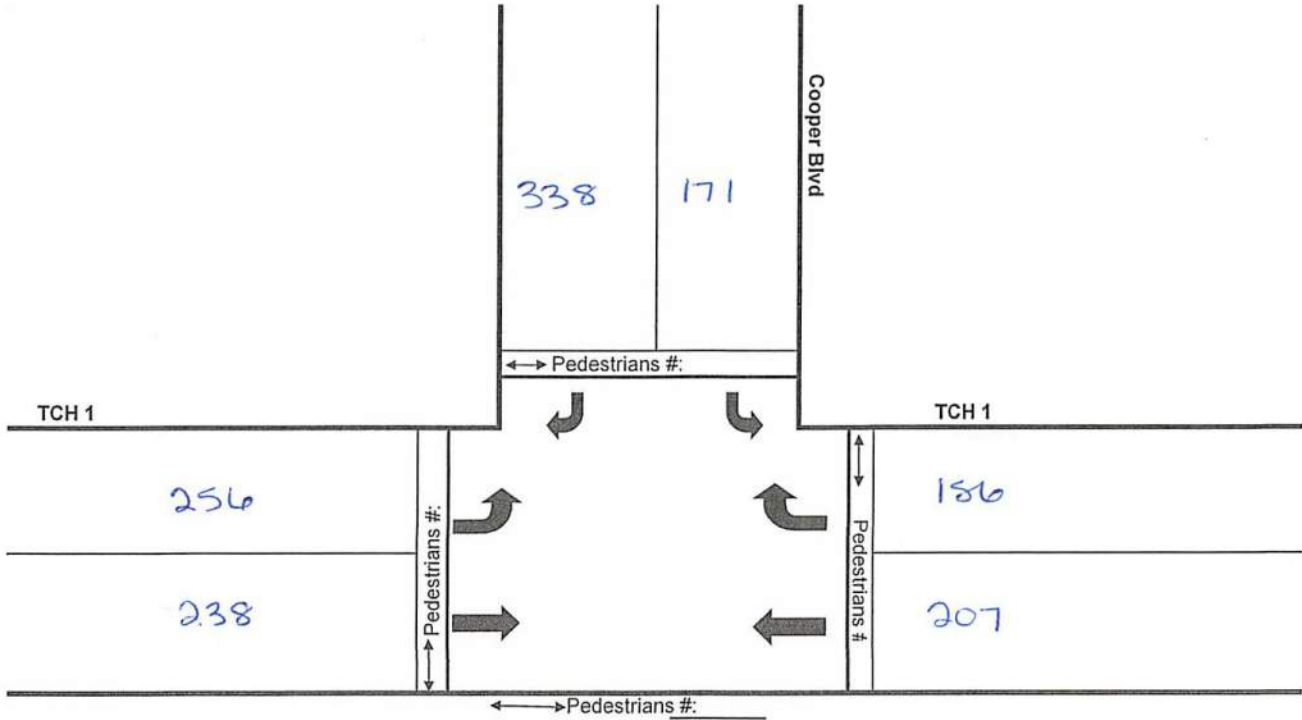

Traffic Count Summary Traffic Movement Counts



Intersection: Cooper Blvd at TCH1 Craig
 Date: Dec 4 2019
 Time: 4:00pm to 6:00pm

Sheet number: Totals

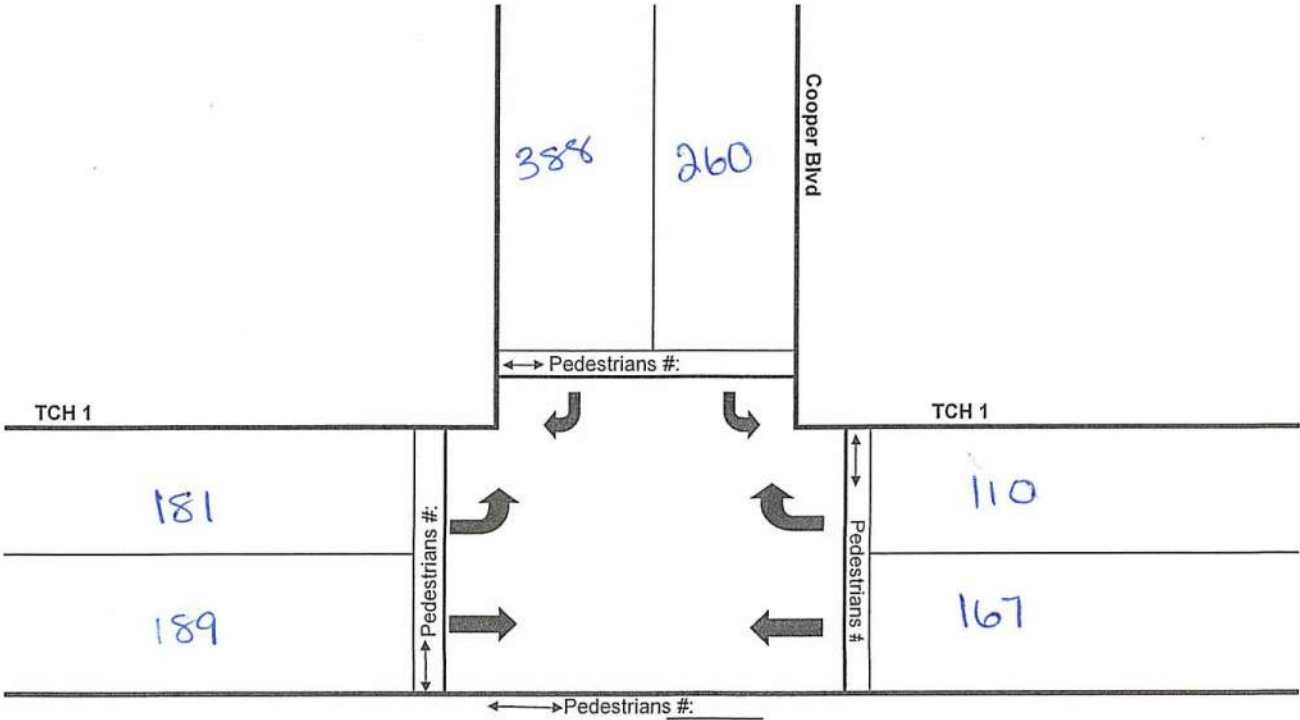

Appendix A
 Saint John Traffic Count
 Intersection Volumes - AM and PM Weekday Peak Hours
 Bayside Drive/Causeway

Traffic Count Summary June 14
 AM and PM Peak Hour Volumes
 Cooper/Raynham

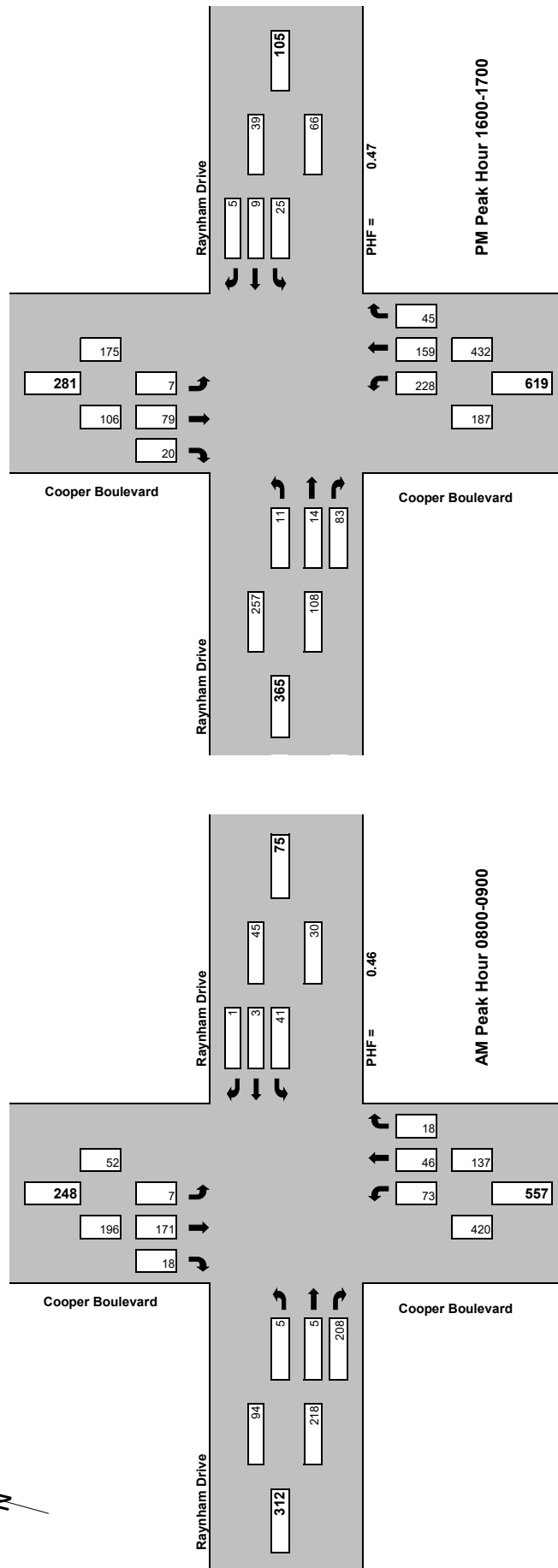
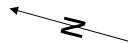

Appendix A
 Saint John Traffic Count
 Intersection Volumes - AM and PM Weekday Peak Hours
 Bayside Drive/Causeway



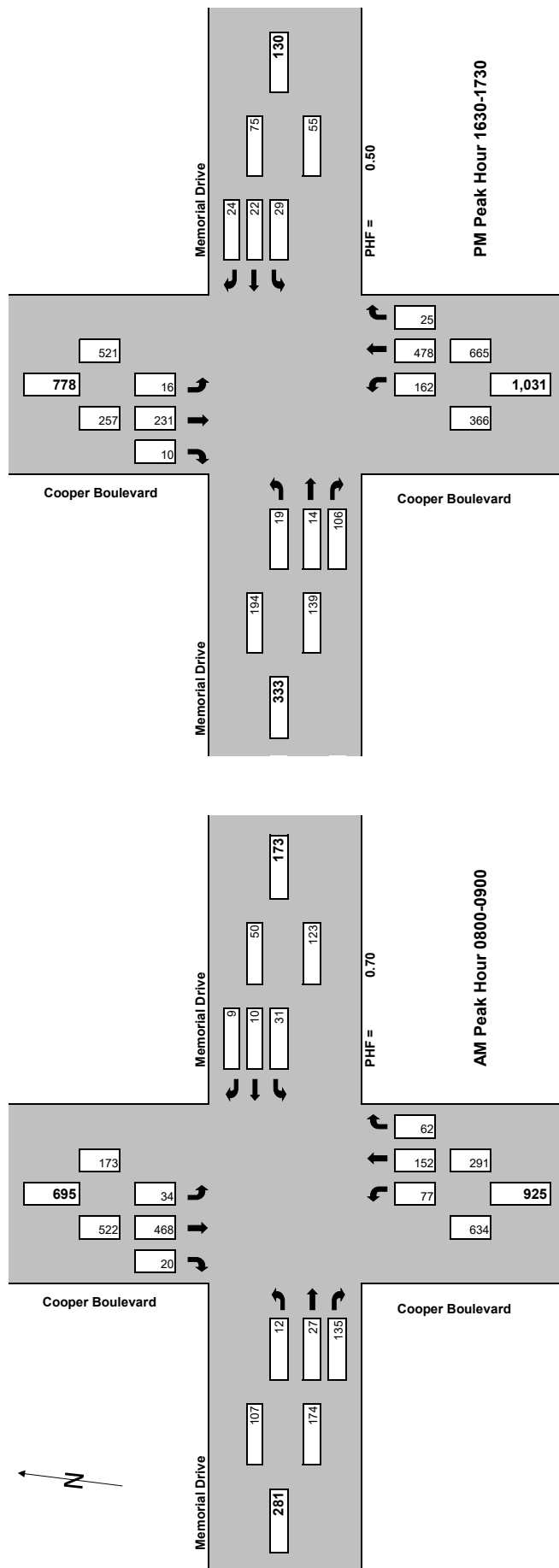







Traffic Count Summary June 14
AM and PM Peak Hour Volumes
Cooper/Memorial



APPENDIX B – SYNCHRO LOS REPORTS























Movement	EBL	EBR	NBL	NBT	SBT	SBR
Lane Configurations						
Traffic Volume (veh/h)	30	35	31	53	125	35
Future Volume (Veh/h)	30	35	31	53	125	35
Sign Control	Stop			Free	Free	
Grade	0%			0%	0%	
Peak Hour Factor	0.92	0.92	0.92	0.92	0.92	0.92
Hourly flow rate (vph)	33	38	34	58	136	38
Pedestrians						
Lane Width (m)						
Walking Speed (m/s)						
Percent Blockage						
Right turn flare (veh)						
Median type				None	None	
Median storage (veh)						
Upstream signal (m)						
pX, platoon unblocked						
vC, conflicting volume	281	155	174			
vC1, stage 1 conf vol						
vC2, stage 2 conf vol						
vCu, unblocked vol	281	155	174			
tC, single (s)	6.4	6.2	4.1			
tC, 2 stage (s)						
tF (s)	3.5	3.3	2.2			
p0 queue free %	95	96	98			
cM capacity (veh/h)	692	891	1403			
Direction, Lane #	EB 1	NB 1	NB 2	SB 1		
Volume Total	71	34	58	174		
Volume Left	33	34	0	0		
Volume Right	38	0	0	38		
cSH	786	1403	1700	1700		
Volume to Capacity	0.09	0.02	0.03	0.10		
Queue Length 95th (m)	2.4	0.6	0.0	0.0		
Control Delay (s)	10.0	7.6	0.0	0.0		
Lane LOS	B	A				
Approach Delay (s)	10.0	2.8		0.0		
Approach LOS	B					
Intersection Summary						
Average Delay			2.9			
Intersection Capacity Utilization			25.8%	ICU Level of Service	A	
Analysis Period (min)			15			

						
Movement	WBL	WBR	NBT	NBR	SBL	SBT
Lane Configurations						
Traffic Volume (veh/h)	68	19	59	11	6	160
Future Volume (Veh/h)	68	19	59	11	6	160
Sign Control	Stop		Free			Free
Grade	0%		0%			0%
Peak Hour Factor	0.92	0.92	0.92	0.92	0.92	0.92
Hourly flow rate (vph)	74	21	64	12	7	174
Pedestrians						
Lane Width (m)						
Walking Speed (m/s)						
Percent Blockage						
Right turn flare (veh)						
Median type	None			None		
Median storage veh						
Upstream signal (m)						
pX, platoon unblocked						
vC, conflicting volume	252	64			64	
vC1, stage 1 conf vol						
vC2, stage 2 conf vol						
vCu, unblocked vol	252	64			64	
tC, single (s)	6.4	6.2			4.1	
tC, 2 stage (s)						
tF (s)	3.5	3.3			2.2	
p0 queue free %	90	98			100	
cM capacity (veh/h)	733	1000			1538	
Direction, Lane #	WB 1	NB 1	NB 2	SB 1	SB 2	
Volume Total	95	64	12	7	174	
Volume Left	74	0	0	7	0	
Volume Right	21	0	12	0	0	
cSH	779	1700	1700	1538	1700	
Volume to Capacity	0.12	0.04	0.01	0.00	0.10	
Queue Length 95th (m)	3.3	0.0	0.0	0.1	0.0	
Control Delay (s)	10.3	0.0	0.0	7.4	0.0	
Lane LOS	B			A		
Approach Delay (s)	10.3	0.0		0.3		
Approach LOS	B					
Intersection Summary						
Average Delay			2.9			
Intersection Capacity Utilization			20.0%	ICU Level of Service	A	
Analysis Period (min)			15			



















Cooper Blvd Corridor Study
3: Cooper Blvd & Raynham Ave

2019 Existing Conditions
Timing Plan: AM Peak

												
Movement	EBL	EBT	EBR	WBL	WBT	WBR	NBL	NBT	NBR	SBL	SBT	SBR
Lane Configurations												
Traffic Volume (veh/h)	5	5	208	41	3	1	73	46	18	7	171	18
Future Volume (Veh/h)	5	5	208	41	3	1	73	46	18	7	171	18
Sign Control		Stop			Stop			Free			Free	
Grade		0%			0%			0%			0%	
Peak Hour Factor	0.92	0.92	0.92	0.92	0.92	0.92	0.92	0.92	0.92	0.92	0.92	0.92
Hourly flow rate (vph)	5	5	226	45	3	1	79	50	20	8	186	20
Pedestrians												
Lane Width (m)												
Walking Speed (m/s)												
Percent Blockage												
Right turn flare (veh)												
Median type												
Median storage veh												
Upstream signal (m)												
pX, platoon unblocked												
vC, conflicting volume	422	420	196	526	430	50	206			50		
vC1, stage 1 conf vol												
vC2, stage 2 conf vol												
vCu, unblocked vol	422	420	196	526	430	50	206			50		
tC, single (s)	7.1	6.5	6.2	7.1	6.5	6.2	4.1			4.1		
tC, 2 stage (s)												
tF (s)	3.5	4.0	3.3	3.5	4.0	3.3	2.2			2.2		
p0 queue free %	99	99	73	86	99	100	94			99		
cM capacity (veh/h)	514	492	845	320	485	1018	1365			1557		
Direction, Lane #	EB 1	WB 1	NB 1	NB 2	NB 3	SB 1	SB 2					
Volume Total	236	49	79	50	20	8	206					
Volume Left	5	45	79	0	0	8	0					
Volume Right	226	1	0	0	20	0	20					
cSH	883	332	1365	1700	1700	1557	1700					
Volume to Capacity	0.27	0.15	0.06	0.03	0.01	0.01	0.12					
Queue Length 95th (m)	8.6	4.1	1.5	0.0	0.0	0.1	0.0					
Control Delay (s)	10.9	17.7	7.8	0.0	0.0	7.3	0.0					
Lane LOS	B	C	A			A						
Approach Delay (s)	10.9	17.7	4.1			0.3						
Approach LOS	B	C										
Intersection Summary												
Average Delay			6.3									
Intersection Capacity Utilization			36.3%		ICU Level of Service				A			
Analysis Period (min)			15									

Cooper Blvd Corridor Study
4: Cooper Blvd & Memorial Dr

2019 Existing Conditions
Timing Plan: AM Peak

												
Movement	EBL	EBT	EBR	WBL	WBT	WBR	NBL	NBT	NBR	SBL	SBT	SBR
Lane Configurations												
Traffic Volume (veh/h)	12	27	135	31	10	9	77	152	62	34	468	20
Future Volume (Veh/h)	12	27	135	31	10	9	77	152	62	34	468	20
Sign Control		Stop			Stop			Free			Free	
Grade		0%			0%			0%			0%	
Peak Hour Factor	0.92	0.92	0.92	0.92	0.92	0.92	0.92	0.92	0.92	0.92	0.92	0.92
Hourly flow rate (vph)	13	29	147	34	11	10	84	165	67	37	509	22
Pedestrians												
Lane Width (m)												
Walking Speed (m/s)												
Percent Blockage												
Right turn flare (veh)												
Median type												
Median storage veh												
Upstream signal (m)												
pX, platoon unblocked												
vC, conflicting volume	932	927	520	964	972	198	531			165		
vC1, stage 1 conf vol												
vC2, stage 2 conf vol												
vCu, unblocked vol	932	927	520	964	972	198	531			165		
tC, single (s)	7.1	6.5	6.2	7.1	6.5	6.2	4.1			4.1		
tC, 2 stage (s)												
tF (s)	3.5	4.0	3.3	3.5	4.0	3.3	2.2			2.2		
p0 queue free %	94	88	74	76	95	99	92			97		
cM capacity (veh/h)	216	240	556	144	226	843	1036			1413		
Direction, Lane #	EB 1	WB 1	NB 1	NB 2	SB 1	SB 2						
Volume Total	189	55	84	232	37	531						
Volume Left	13	34	84	0	37	0						
Volume Right	147	10	0	67	0	22						
cSH	424	186	1036	1700	1413	1700						
Volume to Capacity	0.45	0.30	0.08	0.14	0.03	0.31						
Queue Length 95th (m)	17.9	9.4	2.1	0.0	0.6	0.0						
Control Delay (s)	20.1	32.3	8.8	0.0	7.6	0.0						
Lane LOS	C	D	A		A							
Approach Delay (s)	20.1	32.3	2.3		0.5							
Approach LOS	C	D										
Intersection Summary												
Average Delay			5.9									
Intersection Capacity Utilization			53.6%		ICU Level of Service					A		
Analysis Period (min)			15									

Cooper Blvd Corridor Study
5: Cooper Blvd & Roe Ave

2019 Existing Conditions
Timing Plan: AM Peak

Lane Group	EBL	EBT	EBR	WBL	WBT	WBR	NBL	NBT	NBR	SBL	SBT	SBR
Lane Configurations												
Traffic Volume (vph)	29	129	53	56	73	55	54	117	99	152	280	67
Future Volume (vph)	29	129	53	56	73	55	54	117	99	152	280	67
Satd. Flow (prot)	1770	1863	1583	1770	1863	1583	1770	1863	1583	1770	1863	1583
Flt Permitted	0.706			0.598			0.464			0.645		
Satd. Flow (perm)	1315	1863	1583	1114	1863	1583	864	1863	1583	1201	1863	1583
Satd. Flow (RTOR)			142			142			199			199
Lane Group Flow (vph)	32	140	58	61	79	60	59	127	108	165	304	73
Turn Type	pm+pt	NA	Perm	pm+pt	NA	Perm	pm+pt	NA	NA	pm+pt	NA	NA
Protected Phases	7	4		3	8		5	2		1	6	
Permitted Phases	4		4	8		8	2			6		
Total Split (s)	20.0	34.0	34.0	25.0	39.0	39.0	20.0	40.0		16.0	36.0	
Total Lost Time (s)	6.0	6.0	6.0	6.0	6.0	6.0	6.0	6.0		6.0	6.0	
Act Effct Green (s)	39.0	28.2	28.2	40.1	32.1	32.1	44.4	34.3	0.0	45.1	37.5	0.0
Actuated g/C Ratio	0.37	0.27	0.27	0.38	0.30	0.30	0.42	0.33	0.00	0.43	0.36	0.00
v/c Ratio	0.06	0.28	0.11	0.12	0.14	0.10	0.13	0.21	0.54	0.29	0.46	0.37
Control Delay	18.4	34.3	0.4	19.0	30.9	0.4	18.0	28.8	10.2	19.3	32.3	5.1
Queue Delay	0.0	0.0	0.0	0.0	0.0	0.0	0.0	0.0	0.0	0.0	0.0	0.0
Total Delay	18.4	34.3	0.4	19.0	30.9	0.4	18.0	28.8	10.2	19.3	32.3	5.1
LOS	B	C	A	B	C	A	B	C	B	B	C	A
Approach Delay		23.5			18.1			19.8			24.7	
Approach LOS		C			B			B			C	
Queue Length 50th (m)	4.1	25.6	0.0	7.9	13.9	0.0	7.3	21.2	0.0	21.8	56.5	0.0
Queue Length 95th (m)	10.0	43.5	0.0	16.2	27.0	0.0	15.2	36.9	0.0	36.1	84.6	0.0
Internal Link Dist (m)		98.9			80.2			211.7			510.5	
Turn Bay Length (m)	48.0		10.0	40.0		62.0	97.0		50.0	54.0		50.0
Base Capacity (vph)	547	499	527	573	638	636	516	605	199	569	662	199
Starvation Cap Reductn	0	0	0	0	0	0	0	0	0	0	0	0
Spillback Cap Reductn	0	0	0	0	0	0	0	0	0	0	0	0
Storage Cap Reductn	0	0	0	0	0	0	0	0	0	0	0	0
Reduced v/c Ratio	0.06	0.28	0.11	0.11	0.12	0.09	0.11	0.21	0.54	0.29	0.46	0.37

Intersection Summary

Cycle Length: 115

Actuated Cycle Length: 105.4

Control Type: Actuated-Uncoordinated

Maximum v/c Ratio: 0.54

Intersection Signal Delay: 22.3

Intersection LOS: C









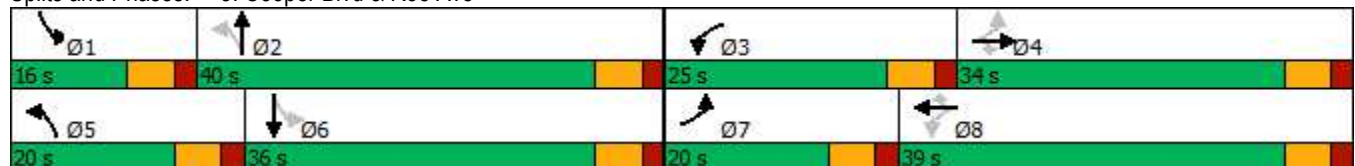

Intersection Capacity Utilization 83.4%

ICU Level of Service E

Analysis Period (min) 15

Splits and Phases: 5: Cooper Blvd & Roe Ave



						
Movement	WBL	WBR	NBT	NBR	SBL	SBT
Lane Configurations						
Traffic Volume (veh/h)	52	107	209	63	138	277
Future Volume (Veh/h)	52	107	209	63	138	277
Sign Control	Stop		Free		Free	
Grade	0%		0%		0%	
Peak Hour Factor	0.92	0.92	0.92	0.92	0.92	0.92
Hourly flow rate (vph)	57	116	227	68	150	301
Pedestrians						
Lane Width (m)						
Walking Speed (m/s)						
Percent Blockage						
Right turn flare (veh)	3					
Median type			None		None	
Median storage veh						
Upstream signal (m)	236					
pX, platoon unblocked						
vC, conflicting volume	862	261			295	
vC1, stage 1 conf vol						
vC2, stage 2 conf vol						
vCu, unblocked vol	862	261			295	
tC, single (s)	6.4	6.2			4.1	
tC, 2 stage (s)						
tF (s)	3.5	3.3			2.2	
p0 queue free %	80	85			88	
cM capacity (veh/h)	287	778			1266	
Direction, Lane #	WB 1	NB 1	SB 1	SB 2		
Volume Total	173	295	150	301		
Volume Left	57	0	150	0		
Volume Right	116	68	0	0		
cSH	871	1700	1266	1700		
Volume to Capacity	0.20	0.17	0.12	0.18		
Queue Length 95th (m)	5.9	0.0	3.2	0.0		
Control Delay (s)	13.8	0.0	8.2	0.0		
Lane LOS	B		A			
Approach Delay (s)	13.8	0.0	2.7			
Approach LOS	B					
Intersection Summary						
Average Delay	3.9					
Intersection Capacity Utilization	35.8%		ICU Level of Service		A	
Analysis Period (min)	15					

Cooper Blvd Corridor Study
7: Cooper Blvd & Airport Blvd

2019 Existing Conditions
Timing Plan: AM Peak

Lane Group	EBL	EBT	EBR	WBL	WBT	WBR	NBL	NBT	NBR	SBL	SBT	SBR
Lane Configurations												
Traffic Volume (vph)	122	82	39	25	81	30	58	128	47	45	112	163
Future Volume (vph)	122	82	39	25	81	30	58	128	47	45	112	163
Satd. Flow (prot)	1770	1773	0	1770	1786	0	1770	1788	0	1770	1697	0
Flt Permitted	0.444			0.673			0.491			0.638		
Satd. Flow (perm)	827	1773	0	1254	1786	0	915	1788	0	1188	1697	0
Satd. Flow (RTOR)		22			17			17			67	
Lane Group Flow (vph)	133	131	0	27	121	0	63	190	0	49	299	0
Turn Type	pm+pt	NA		pm+pt	NA		pm+pt	NA		pm+pt	NA	
Protected Phases	7	4		3	8		5	2		1	6	
Permitted Phases	4			8			2			6		
Total Split (s)	20.0	30.0		20.0	30.0		22.0	30.0		22.0	30.0	
Total Lost Time (s)	6.0	6.0		6.0	6.0		6.0	6.0		6.0	6.0	
Act Effct Green (s)	22.7	19.6		14.8	11.8		36.0	34.0		35.3	31.7	
Actuated g/C Ratio	0.32	0.28		0.21	0.17		0.51	0.48		0.50	0.45	
v/c Ratio	0.33	0.26		0.09	0.39		0.11	0.22		0.07	0.37	
Control Delay	19.7	21.9		17.6	31.5		12.3	19.4		12.0	19.0	
Queue Delay	0.0	0.0		0.0	0.0		0.0	0.0		0.0	0.0	
Total Delay	19.7	21.9		17.6	31.5		12.3	19.4		12.0	19.0	
LOS	B	C		B	C		B	B		B	B	
Approach Delay		20.8			28.9			17.6			18.0	
Approach LOS		C			C			B			B	
Queue Length 50th (m)	14.1	11.4		2.7	14.9		4.8	19.9		3.7	27.6	
Queue Length 95th (m)	26.6	30.6		7.8	32.1		12.7	41.3		10.6	59.2	
Internal Link Dist (m)		87.0			101.4			173.0			438.1	
Turn Bay Length (m)	21.0			50.0			78.0			82.0		
Base Capacity (vph)	502	686		525	670		719	870		804	798	
Starvation Cap Reductn	0	0		0	0		0	0		0	0	
Spillback Cap Reductn	0	0		0	0		0	0		0	0	
Storage Cap Reductn	0	0		0	0		0	0		0	0	
Reduced v/c Ratio	0.26	0.19		0.05	0.18		0.09	0.22		0.06	0.37	

Intersection Summary

Cycle Length: 102

Actuated Cycle Length: 70.6

Control Type: Actuated-Uncoordinated

Maximum v/c Ratio: 0.39

Intersection Signal Delay: 20.2

Intersection LOS: C

Intersection Capacity Utilization 56.8%

ICU Level of Service B

Analysis Period (min) 15

Splits and Phases: 7: Cooper Blvd & Airport Blvd

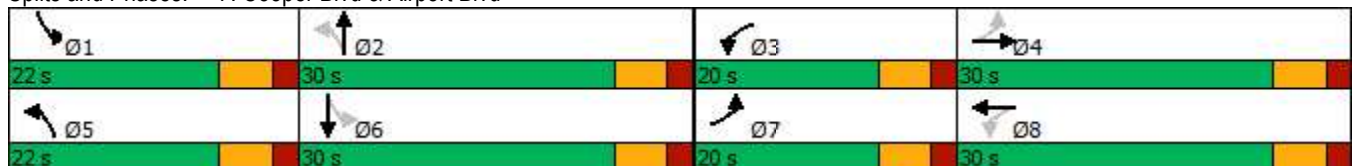













Movement	EBL	EBR	NBL	NBT	SBT	SBR
Lane Configurations						
Traffic Volume (veh/h)	48	21	29	162	77	75
Future Volume (Veh/h)	48	21	29	162	77	75
Sign Control	Stop			Free	Free	
Grade	0%			0%	0%	
Peak Hour Factor	0.92	0.92	0.92	0.92	0.92	0.92
Hourly flow rate (vph)	52	23	32	176	84	82
Pedestrians						
Lane Width (m)						
Walking Speed (m/s)						
Percent Blockage						
Right turn flare (veh)						
Median type				None	None	
Median storage veh						
Upstream signal (m)				197		
pX, platoon unblocked						
vC, conflicting volume	324	84	84			
vC1, stage 1 conf vol						
vC2, stage 2 conf vol						
vCu, unblocked vol	324	84	84			
tC, single (s)	6.4	6.2	4.1			
tC, 2 stage (s)						
tF (s)	3.5	3.3	2.2			
p0 queue free %	92	98	98			
cM capacity (veh/h)	656	975	1513			
Direction, Lane #	EB 1	NB 1	NB 2	SB 1	SB 2	
Volume Total	75	32	176	84	82	
Volume Left	52	32	0	0	0	
Volume Right	23	0	0	0	82	
cSH	729	1513	1700	1700	1700	
Volume to Capacity	0.10	0.02	0.10	0.05	0.05	
Queue Length 95th (m)	2.7	0.5	0.0	0.0	0.0	
Control Delay (s)	10.5	7.4	0.0	0.0	0.0	
Lane LOS	B	A				
Approach Delay (s)	10.5	1.1		0.0		
Approach LOS	B					
Intersection Summary						
Average Delay			2.3			
Intersection Capacity Utilization			19.1%	ICU Level of Service	A	
Analysis Period (min)			15			



Movement	EBL	EBT	WBT	WBR	SBL	SBR
Lane Configurations						
Traffic Volume (veh/h)	128	59	84	89	28	61
Future Volume (Veh/h)	128	59	84	89	28	61
Sign Control		Free	Free		Stop	
Grade		0%	0%		0%	
Peak Hour Factor	0.92	0.92	0.92	0.92	0.92	0.92
Hourly flow rate (vph)	139	64	91	97	30	66
Pedestrians						
Lane Width (m)						
Walking Speed (m/s)						
Percent Blockage						
Right turn flare (veh)						
Median type		None	None			
Median storage (veh)						
Upstream signal (m)						
pX, platoon unblocked						
vC, conflicting volume	91				433	91
vC1, stage 1 conf vol						
vC2, stage 2 conf vol						
vCu, unblocked vol	91				433	91
tC, single (s)	4.1				6.4	6.2
tC, 2 stage (s)						
tF (s)	2.2				3.5	3.3
p0 queue free %	91				94	93
cM capacity (veh/h)	1504				526	967
Direction, Lane #	EB 1	EB 2	WB 1	WB 2	SB 1	
Volume Total	139	64	91	97	96	
Volume Left	139	0	0	0	30	
Volume Right	0	0	0	97	66	
cSH	1504	1700	1700	1700	766	
Volume to Capacity	0.09	0.04	0.05	0.06	0.13	
Queue Length 95th (m)	2.4	0.0	0.0	0.0	3.4	
Control Delay (s)	7.6	0.0	0.0	0.0	10.4	
Lane LOS	A				B	
Approach Delay (s)	5.2		0.0		10.4	
Approach LOS					B	
Intersection Summary						
Average Delay			4.2			
Intersection Capacity Utilization			25.7%		ICU Level of Service	A
Analysis Period (min)			15			























Movement	EBL	EBR	NBL	NBT	SBT	SBR
Lane Configurations						
Traffic Volume (veh/h)	34	35	43	121	44	8
Future Volume (Veh/h)	34	35	43	121	44	8
Sign Control	Stop			Free	Free	
Grade	0%			0%	0%	
Peak Hour Factor	0.92	0.92	0.92	0.92	0.92	0.92
Hourly flow rate (vph)	37	38	47	132	48	9
Pedestrians						
Lane Width (m)						
Walking Speed (m/s)						
Percent Blockage						
Right turn flare (veh)						
Median type				None	None	
Median storage (veh)						
Upstream signal (m)						
pX, platoon unblocked						
vC, conflicting volume	278	52	57			
vC1, stage 1 conf vol						
vC2, stage 2 conf vol						
vCu, unblocked vol	278	52	57			
tC, single (s)	6.4	6.2	4.1			
tC, 2 stage (s)						
tF (s)	3.5	3.3	2.2			
p0 queue free %	95	96	97			
cM capacity (veh/h)	690	1015	1547			
Direction, Lane #	EB 1	NB 1	NB 2	SB 1		
Volume Total	75	47	132	57		
Volume Left	37	47	0	0		
Volume Right	38	0	0	9		
cSH	823	1547	1700	1700		
Volume to Capacity	0.09	0.03	0.08	0.03		
Queue Length 95th (m)	2.4	0.8	0.0	0.0		
Control Delay (s)	9.8	7.4	0.0	0.0		
Lane LOS	A	A				
Approach Delay (s)	9.8	1.9	0.0			
Approach LOS	A					
Intersection Summary						
Average Delay	3.5					
Intersection Capacity Utilization	19.7%			ICU Level of Service	A	
Analysis Period (min)	15					

						
Movement	WBL	WBR	NBT	NBR	SBL	SBT
Lane Configurations						
Traffic Volume (veh/h)	24	11	143	40	14	56
Future Volume (Veh/h)	24	11	143	40	14	56
Sign Control	Stop		Free		Free	
Grade	0%		0%		0%	
Peak Hour Factor	0.92	0.92	0.92	0.92	0.92	0.92
Hourly flow rate (vph)	26	12	155	43	15	61
Pedestrians						
Lane Width (m)						
Walking Speed (m/s)						
Percent Blockage						
Right turn flare (veh)						
Median type			None		None	
Median storage veh)						
Upstream signal (m)						
pX, platoon unblocked						
vC, conflicting volume	246	155			155	
vC1, stage 1 conf vol						
vC2, stage 2 conf vol						
vCu, unblocked vol	246	155			155	
tC, single (s)	6.4	6.2			4.1	
tC, 2 stage (s)						
tF (s)	3.5	3.3			2.2	
p0 queue free %	96	99			99	
cM capacity (veh/h)	735	891			1425	
Direction, Lane #	WB 1	NB 1	NB 2	SB 1	SB 2	
Volume Total	38	155	43	15	61	
Volume Left	26	0	0	15	0	
Volume Right	12	0	43	0	0	
cSH	778	1700	1700	1425	1700	
Volume to Capacity	0.05	0.09	0.03	0.01	0.04	
Queue Length 95th (m)	1.2	0.0	0.0	0.3	0.0	
Control Delay (s)	9.9	0.0	0.0	7.6	0.0	
Lane LOS	A		A			
Approach Delay (s)	9.9	0.0		1.5		
Approach LOS	A					
Intersection Summary						
Average Delay			1.6			
Intersection Capacity Utilization			21.6%		ICU Level of Service	A
Analysis Period (min)			15			



















Cooper Blvd Corridor Study
3: Cooper Blvd & Raynham Ave

2019 Existing Conditions
Timing Plan: AM Peak

												
Movement	EBL	EBT	EBR	WBL	WBT	WBR	NBL	NBT	NBR	SBL	SBT	SBR
Lane Configurations												
Traffic Volume (veh/h)	11	14	83	25	9	5	228	159	45	7	79	20
Future Volume (Veh/h)	11	14	83	25	9	5	228	159	45	7	79	20
Sign Control		Stop			Stop			Free			Free	
Grade		0%			0%			0%			0%	
Peak Hour Factor	0.92	0.92	0.92	0.92	0.92	0.92	0.92	0.92	0.92	0.92	0.92	0.92
Hourly flow rate (vph)	12	15	90	27	10	5	248	173	49	8	86	22
Pedestrians												
Lane Width (m)												
Walking Speed (m/s)												
Percent Blockage												
Right turn flare (veh)												
Median type												
Median storage veh												
Upstream signal (m)												
pX, platoon unblocked												
vC, conflicting volume	787	782	97	824	793	173	108			173		
vC1, stage 1 conf vol												
vC2, stage 2 conf vol												
vCu, unblocked vol	787	782	97	824	793	173	108			173		
tC, single (s)	7.1	6.5	6.2	7.1	6.5	6.2	4.1			4.1		
tC, 2 stage (s)												
tF (s)	3.5	4.0	3.3	3.5	4.0	3.3	2.2			2.2		
p0 queue free %	95	94	91	88	96	99	83			99		
cM capacity (veh/h)	259	270	959	220	266	871	1483			1404		
Direction, Lane #	EB 1	WB 1	NB 1	NB 2	NB 3	SB 1	SB 2					
Volume Total	117	42	248	173	49	8	108					
Volume Left	12	27	248	0	0	8	0					
Volume Right	90	5	0	0	49	0	22					
cSH	1149	253	1483	1700	1700	1404	1700					
Volume to Capacity	0.10	0.17	0.17	0.10	0.03	0.01	0.06					
Queue Length 95th (m)	2.7	4.7	4.8	0.0	0.0	0.1	0.0					
Control Delay (s)	11.7	22.0	7.9	0.0	0.0	7.6	0.0					
Lane LOS	B	C	A			A						
Approach Delay (s)	11.7	22.0	4.2			0.5						
Approach LOS	B	C										
Intersection Summary												
Average Delay			5.8									
Intersection Capacity Utilization			34.8%		ICU Level of Service				A			
Analysis Period (min)			15									

Cooper Blvd Corridor Study
4: Cooper Blvd & Memorial Dr

2019 Existing Conditions
Timing Plan: AM Peak

												
Movement	EBL	EBT	EBR	WBL	WBT	WBR	NBL	NBT	NBR	SBL	SBT	SBR
Lane Configurations												
Traffic Volume (veh/h)	19	14	106	29	22	24	162	478	25	16	231	10
Future Volume (Veh/h)	19	14	106	29	22	24	162	478	25	16	231	10
Sign Control		Stop			Stop			Free			Free	
Grade		0%			0%			0%			0%	
Peak Hour Factor	0.92	0.92	0.92	0.92	0.92	0.92	0.92	0.92	0.92	0.92	0.92	0.92
Hourly flow rate (vph)	21	15	115	32	24	26	176	520	27	17	251	11
Pedestrians												
Lane Width (m)												
Walking Speed (m/s)												
Percent Blockage												
Right turn flare (veh)												
Median type												
Median storage veh												
Upstream signal (m)												
pX, platoon unblocked												
vC, conflicting volume	1174	1162	256	1178	1182	534	262			520		
vC1, stage 1 conf vol												
vC2, stage 2 conf vol												
vCu, unblocked vol	1174	1162	256	1178	1182	534	262			520		
tC, single (s)	7.1	6.5	6.2	7.1	6.5	6.2	4.1			4.1		
tC, 2 stage (s)												
tF (s)	3.5	4.0	3.3	3.5	4.0	3.3	2.2			2.2		
p0 queue free %	83	91	85	73	85	95	86			98		
cM capacity (veh/h)	126	166	782	118	161	546	1302			1046		
Direction, Lane #	EB 1	WB 1	NB 1	NB 2	SB 1	SB 2						
Volume Total	151	82	176	547	17	262						
Volume Left	21	32	176	0	17	0						
Volume Right	115	26	0	27	0	11						
cSH	374	176	1302	1700	1046	1700						
Volume to Capacity	0.40	0.47	0.14	0.32	0.02	0.15						
Queue Length 95th (m)	15.2	17.7	3.7	0.0	0.4	0.0						
Control Delay (s)	21.0	42.3	8.2	0.0	8.5	0.0						
Lane LOS	C	E	A		A							
Approach Delay (s)	21.0	42.3	2.0		0.5							
Approach LOS	C	E										
Intersection Summary												
Average Delay			6.7									
Intersection Capacity Utilization			49.4%		ICU Level of Service					A		
Analysis Period (min)			15									

Cooper Blvd Corridor Study
5: Cooper Blvd & Roe Ave

2019 Existing Conditions
Timing Plan: AM Peak

Lane Group	EBL	EBT	EBR	WBL	WBT	WBR	NBL	NBT	NBR	SBL	SBT	SBR
Lane Configurations												
Traffic Volume (vph)	100	126	33	141	173	193	47	258	63	67	109	23
Future Volume (vph)	100	126	33	141	173	193	47	258	63	67	109	23
Satd. Flow (prot)	1770	1863	1583	1770	1863	1583	1770	1863	1583	1770	1863	1583
Flt Permitted	0.576			0.661			0.657			0.464		
Satd. Flow (perm)	1073	1863	1583	1231	1863	1583	1224	1863	1583	864	1863	1583
Satd. Flow (RTOR)			142			210			199			199
Lane Group Flow (vph)	109	137	36	153	188	210	51	280	68	73	118	25
Turn Type	pm+pt	NA	Perm	pm+pt	NA	Perm	pm+pt	NA	NA	pm+pt	NA	NA
Protected Phases	7	4		3	8		5	2		1	6	
Permitted Phases	4		4	8		8	2			6		
Total Split (s)	20.0	34.0	34.0	25.0	39.0	39.0	20.0	36.0		20.0	36.0	
Total Lost Time (s)	6.0	6.0	6.0	6.0	6.0	6.0	6.0	6.0		6.0	6.0	
Act Effct Green (s)	42.2	28.1	28.1	42.4	28.3	28.3	39.0	31.3	0.0	36.9	30.2	0.0
Actuated g/C Ratio	0.41	0.27	0.27	0.41	0.27	0.27	0.38	0.30	0.00	0.36	0.29	0.00
v/c Ratio	0.20	0.27	0.07	0.26	0.37	0.36	0.10	0.50	0.34	0.19	0.22	0.13
Control Delay	18.0	32.5	0.2	18.5	33.9	6.2	18.3	34.2	4.6	19.5	30.2	1.3
Queue Delay	0.0	0.0	0.0	0.0	0.0	0.0	0.0	0.0	0.0	0.0	0.0	0.0
Total Delay	18.0	32.5	0.2	18.5	33.9	6.2	18.3	34.2	4.6	19.5	30.2	1.3
LOS	B	C	A	B	C	A	B	C	A	B	C	A
Approach Delay		22.8			19.1			27.1			23.2	
Approach LOS		C			B			C			C	
Queue Length 50th (m)	13.4	23.6	0.0	19.3	33.4	0.0	6.3	49.8	0.0	9.2	19.6	0.0
Queue Length 95th (m)	24.5	41.4	0.0	33.0	54.6	17.7	13.9	79.5	0.0	18.3	35.2	0.0
Internal Link Dist (m)		98.9			80.2			211.7			510.5	
Turn Bay Length (m)	48.0		10.0	40.0		62.0	97.0		50.0	54.0		50.0
Base Capacity (vph)	534	508	535	665	599	651	573	565	199	468	546	199
Starvation Cap Reductn	0	0	0	0	0	0	0	0	0	0	0	0
Spillback Cap Reductn	0	0	0	0	0	0	0	0	0	0	0	0
Storage Cap Reductn	0	0	0	0	0	0	0	0	0	0	0	0
Reduced v/c Ratio	0.20	0.27	0.07	0.23	0.31	0.32	0.09	0.50	0.34	0.16	0.22	0.13

Intersection Summary

Cycle Length: 115

Actuated Cycle Length: 103

Control Type: Actuated-Uncoordinated

Maximum v/c Ratio: 0.50

Intersection Signal Delay: 22.6

Intersection LOS: C









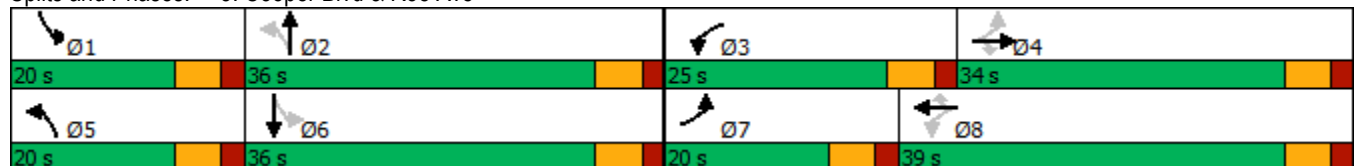

Intersection Capacity Utilization 83.3%

ICU Level of Service E

Analysis Period (min) 15

Splits and Phases: 5: Cooper Blvd & Roe Ave



						
Movement	WBL	WBR	NBT	NBR	SBL	SBT
Lane Configurations						
Traffic Volume (veh/h)	34	90	388	51	54	313
Future Volume (Veh/h)	34	90	388	51	54	313
Sign Control	Stop		Free		Free	
Grade	0%		0%		0%	
Peak Hour Factor	0.92	0.92	0.92	0.92	0.92	0.92
Hourly flow rate (vph)	37	98	422	55	59	340
Pedestrians						
Lane Width (m)						
Walking Speed (m/s)						
Percent Blockage						
Right turn flare (veh)	3					
Median type			None		None	
Median storage veh						
Upstream signal (m)						236
pX, platoon unblocked	0.97					
vC, conflicting volume	908	450			477	
vC1, stage 1 conf vol						
vC2, stage 2 conf vol						
vCu, unblocked vol	889	450			477	
tC, single (s)	6.4	6.2			4.1	
tC, 2 stage (s)						
tF (s)	3.5	3.3			2.2	
p0 queue free %	87	84			95	
cM capacity (veh/h)	288	610			1085	
Direction, Lane #	WB 1	NB 1	SB 1	SB 2		
Volume Total	135	477	59	340		
Volume Left	37	0	59	0		
Volume Right	98	55	0	0		
cSH	840	1700	1085	1700		
Volume to Capacity	0.16	0.28	0.05	0.20		
Queue Length 95th (m)	4.6	0.0	1.4	0.0		
Control Delay (s)	14.0	0.0	8.5	0.0		
Lane LOS	B		A			
Approach Delay (s)	14.0	0.0	1.3			
Approach LOS	B					
Intersection Summary						
Average Delay			2.4			
Intersection Capacity Utilization			40.2%	ICU Level of Service	A	
Analysis Period (min)	15					

Cooper Blvd Corridor Study
7: Cooper Blvd & Airport Blvd

2019 Existing Conditions
Timing Plan: AM Peak

Lane Group	EBL	EBT	EBR	WBL	WBT	WBR	NBL	NBT	NBR	SBL	SBT	SBR
Lane Configurations												
Traffic Volume (vph)	175	34	55	52	135	77	36	155	26	21	135	154
Future Volume (vph)	175	34	55	52	135	77	36	155	26	21	135	154
Satd. Flow (prot)	1770	1690	0	1770	1760	0	1770	1824	0	1770	1714	0
Flt Permitted	0.364			0.694			0.416			0.634		
Satd. Flow (perm)	678	1690	0	1293	1760	0	775	1824	0	1181	1714	0
Satd. Flow (RTOR)		60			26			8			52	
Lane Group Flow (vph)	190	97	0	57	231	0	39	196	0	23	314	0
Turn Type	pm+pt	NA		pm+pt	NA		pm+pt	NA		pm+pt	NA	
Protected Phases	7	4		3	8		5	2		1	6	
Permitted Phases	4			8			2			6		
Total Split (s)	20.0	30.0		20.0	30.0		22.0	30.0		22.0	30.0	
Total Lost Time (s)	6.0	6.0		6.0	6.0		6.0	6.0		6.0	6.0	
Act Effct Green (s)	32.5	25.3		21.8	14.7		29.9	27.2		29.1	24.9	
Actuated g/C Ratio	0.42	0.33		0.28	0.19		0.39	0.35		0.38	0.32	
v/c Ratio	0.42	0.16		0.14	0.65		0.10	0.30		0.05	0.53	
Control Delay	18.2	12.4		15.9	35.8		15.6	22.5		15.3	24.7	
Queue Delay	0.0	0.0		0.0	0.0		0.0	0.0		0.0	0.0	
Total Delay	18.2	12.4		15.9	35.8		15.6	22.5		15.3	24.7	
LOS	B	B		B	D		B	C		B	C	
Approach Delay		16.2			31.9			21.4			24.1	
Approach LOS		B			C			C			C	
Queue Length 50th (m)	20.3	4.7		5.6	31.9		3.5	18.3		2.0	36.5	
Queue Length 95th (m)	35.5	16.7		12.9	56.9		10.5	49.2		7.2	72.8	
Internal Link Dist (m)		87.0			101.4			173.0			438.1	
Turn Bay Length (m)	21.0			50.0			78.0			82.0		
Base Capacity (vph)	490	611		578	582		534	649		616	588	
Starvation Cap Reductn	0	0		0	0		0	0		0	0	
Spillback Cap Reductn	0	0		0	0		0	0		0	0	
Storage Cap Reductn	0	0		0	0		0	0		0	0	
Reduced v/c Ratio	0.39	0.16		0.10	0.40		0.07	0.30		0.04	0.53	

Intersection Summary

Cycle Length: 102

Actuated Cycle Length: 77.1

Control Type: Actuated-Uncoordinated

Maximum v/c Ratio: 0.65

Intersection Signal Delay: 23.5

Intersection LOS: C

Intersection Capacity Utilization 63.9%

ICU Level of Service B

Analysis Period (min) 15

Splits and Phases: 7: Cooper Blvd & Airport Blvd

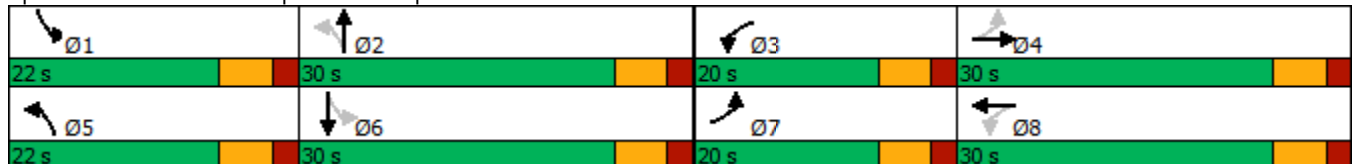



Movement	EBL	EBR	NBL	NBT	SBT	SBR
Lane Configurations						
Traffic Volume (veh/h)	179	65	38	108	231	149
Future Volume (Veh/h)	179	65	38	108	231	149
Sign Control	Stop			Free	Free	
Grade	0%			0%	0%	
Peak Hour Factor	0.92	0.92	0.92	0.92	0.92	0.92
Hourly flow rate (vph)	195	71	41	117	251	162
Pedestrians						
Lane Width (m)						
Walking Speed (m/s)						
Percent Blockage						
Right turn flare (veh)						
Median type				None	None	
Median storage veh						
Upstream signal (m)					197	
pX, platoon unblocked						
vC, conflicting volume	450	251	251			
vC1, stage 1 conf vol						
vC2, stage 2 conf vol						
vCu, unblocked vol	450	251	251			
tC, single (s)	6.4	6.2	4.1			
tC, 2 stage (s)						
tF (s)	3.5	3.3	2.2			
p0 queue free %	64	91	97			
cM capacity (veh/h)	549	788	1314			
Direction, Lane #	EB 1	NB 1	NB 2	SB 1	SB 2	
Volume Total	266	41	117	251	162	
Volume Left	195	41	0	0	0	
Volume Right	71	0	0	0	162	
cSH	597	1314	1700	1700	1700	
Volume to Capacity	0.45	0.03	0.07	0.15	0.10	
Queue Length 95th (m)	18.3	0.8	0.0	0.0	0.0	
Control Delay (s)	15.8	7.8	0.0	0.0	0.0	
Lane LOS	C	A				
Approach Delay (s)	15.8	2.0		0.0		
Approach LOS	C					
Intersection Summary						
Average Delay			5.4			
Intersection Capacity Utilization			39.4%	ICU Level of Service	A	
Analysis Period (min)			15			



Movement	EBL	EBT	WBT	WBR	SBL	SBR
Lane Configurations						
Traffic Volume (veh/h)	98	118	91	74	143	208
Future Volume (Veh/h)	98	118	91	74	143	208
Sign Control		Free	Free		Stop	
Grade		0%	0%		0%	
Peak Hour Factor	0.92	0.92	0.92	0.92	0.92	0.92
Hourly flow rate (vph)	107	128	99	80	155	226
Pedestrians						
Lane Width (m)						
Walking Speed (m/s)						
Percent Blockage						
Right turn flare (veh)						
Median type		None	None			
Median storage (veh)						
Upstream signal (m)						
pX, platoon unblocked						
vC, conflicting volume	99				441	99
vC1, stage 1 conf vol						
vC2, stage 2 conf vol						
vCu, unblocked vol	99				441	99
tC, single (s)	4.1				6.4	6.2
tC, 2 stage (s)						
tF (s)	2.2				3.5	3.3
p0 queue free %	93				71	76
cM capacity (veh/h)	1494				533	957
Direction, Lane #	EB 1	EB 2	WB 1	WB 2	SB 1	
Volume Total	107	128	99	80	381	
Volume Left	107	0	0	0	155	
Volume Right	0	0	0	80	226	
cSH	1494	1700	1700	1700	723	
Volume to Capacity	0.07	0.08	0.06	0.05	0.53	
Queue Length 95th (m)	1.8	0.0	0.0	0.0	24.9	
Control Delay (s)	7.6	0.0	0.0	0.0	15.4	
Lane LOS	A				C	
Approach Delay (s)	3.5		0.0		15.4	
Approach LOS					C	
Intersection Summary						
Average Delay			8.4			
Intersection Capacity Utilization			39.5%		ICU Level of Service	A
Analysis Period (min)			15			

Cooper Blvd Corridor Study
1: Cooper Blvd & Magee Rd











2030 Projected Conditions
Timing Plan: AM Peak



Movement	EBL	EBR	NBL	NBT	SBT	SBR
Lane Configurations						
Traffic Volume (veh/h)	33	104	59	112	217	39
Future Volume (Veh/h)	33	104	59	112	217	39
Sign Control	Stop			Free	Free	
Grade	0%			0%	0%	
Peak Hour Factor	0.92	0.92	0.92	0.92	0.92	0.92
Hourly flow rate (vph)	36	113	64	122	236	42
Pedestrians						
Lane Width (m)						
Walking Speed (m/s)						
Percent Blockage						
Right turn flare (veh)						
Median type				None	None	
Median storage (veh)						
Upstream signal (m)						
pX, platoon unblocked						
vC, conflicting volume	507	257	278			
vC1, stage 1 conf vol						
vC2, stage 2 conf vol						
vCu, unblocked vol	507	257	278			
tC, single (s)	6.4	6.2	4.1			
tC, 2 stage (s)						
tF (s)	3.5	3.3	2.2			
p0 queue free %	93	86	95			
cM capacity (veh/h)	499	782	1285			
Direction, Lane #	EB 1	NB 1	NB 2	SB 1		
Volume Total	149	64	122	278		
Volume Left	36	64	0	0		
Volume Right	113	0	0	42		
cSH	688	1285	1700	1700		
Volume to Capacity	0.22	0.05	0.07	0.16		
Queue Length 95th (m)	6.6	1.3	0.0	0.0		
Control Delay (s)	11.7	7.9	0.0	0.0		
Lane LOS	B	A				
Approach Delay (s)	11.7	2.7		0.0		
Approach LOS	B					
Intersection Summary						
Average Delay			3.7			
Intersection Capacity Utilization			35.4%	ICU Level of Service	A	
Analysis Period (min)			15			

Cooper Blvd Corridor Study
2: Cooper Blvd & Mitchell St

2030 Projected Conditions
Timing Plan: AM Peak





















						
Movement	WBL	WBR	NBT	NBR	SBL	SBT
Lane Configurations						
Traffic Volume (veh/h)	75	21	144	12	7	322
Future Volume (Veh/h)	75	21	144	12	7	322
Sign Control	Stop		Free		Free	
Grade	0%		0%		0%	
Peak Hour Factor	0.92	0.92	0.92	0.92	0.92	0.92
Hourly flow rate (vph)	82	23	157	13	8	350
Pedestrians						
Lane Width (m)						
Walking Speed (m/s)						
Percent Blockage						
Right turn flare (veh)						
Median type	None			None		
Median storage veh						
Upstream signal (m)						
pX, platoon unblocked						
vC, conflicting volume	523	157			157	
vC1, stage 1 conf vol						
vC2, stage 2 conf vol						
vCu, unblocked vol	523	157			157	
tC, single (s)	6.4	6.2			4.1	
tC, 2 stage (s)						
tF (s)	3.5	3.3			2.2	
p0 queue free %	84	97			99	
cM capacity (veh/h)	511	889			1423	
Direction, Lane #	WB 1	NB 1	NB 2	SB 1	SB 2	
Volume Total	105	157	13	8	350	
Volume Left	82	0	0	8	0	
Volume Right	23	0	13	0	0	
cSH	564	1700	1700	1423	1700	
Volume to Capacity	0.19	0.09	0.01	0.01	0.21	
Queue Length 95th (m)	5.4	0.0	0.0	0.1	0.0	
Control Delay (s)	12.8	0.0	0.0	7.5	0.0	
Lane LOS	B			A		
Approach Delay (s)	12.8	0.0		0.2		
Approach LOS	B					
Intersection Summary						
Average Delay			2.2			
Intersection Capacity Utilization			29.1%	ICU Level of Service	A	
Analysis Period (min)	15					



Movement	EBL	EBR	NBL	NBT	SBT	SBR
Lane Configurations						
Traffic Volume (veh/h)	15	115	25	122	387	10
Future Volume (Veh/h)	15	115	25	122	387	10
Sign Control	Stop			Free	Free	
Grade	0%			0%	0%	
Peak Hour Factor	0.92	0.92	0.92	0.92	0.92	0.92
Hourly flow rate (vph)	16	125	27	133	421	11
Pedestrians						
Lane Width (m)						
Walking Speed (m/s)						
Percent Blockage						
Right turn flare (veh)						
Median type				None	None	
Median storage (veh)						
Upstream signal (m)						
pX, platoon unblocked						
vC, conflicting volume	614	426	432			
vC1, stage 1 conf vol						
vC2, stage 2 conf vol						
vCu, unblocked vol	614	426	432			
tC, single (s)	6.4	6.2	4.1			
tC, 2 stage (s)						
tF (s)	3.5	3.3	2.2			
p0 queue free %	96	80	98			
cM capacity (veh/h)	445	628	1128			
Direction, Lane #	EB 1	NB 1	SB 1			
Volume Total	141	160	432			
Volume Left	16	27	0			
Volume Right	125	0	11			
cSH	600	1128	1700			
Volume to Capacity	0.24	0.02	0.25			
Queue Length 95th (m)	7.3	0.6	0.0			
Control Delay (s)	12.8	1.6	0.0			
Lane LOS	B	A				
Approach Delay (s)	12.8	1.6	0.0			
Approach LOS	B					
Intersection Summary						
Average Delay			2.8			
Intersection Capacity Utilization			42.4%	ICU Level of Service	A	
Analysis Period (min)			15			



















Cooper Blvd Corridor Study
3: Cooper Blvd & Raynham Ave

2030 Projected Conditions
Timing Plan: AM Peak

												
Movement	EBL	EBT	EBR	WBL	WBT	WBR	NBL	NBT	NBR	SBL	SBT	SBR
Lane Configurations												
Traffic Volume (veh/h)	6	15	262	116	29	11	95	130	43	11	436	20
Future Volume (Veh/h)	6	15	262	116	29	11	95	130	43	11	436	20
Sign Control		Stop			Stop			Free			Free	
Grade		0%			0%			0%			0%	
Peak Hour Factor	0.92	0.92	0.92	0.92	0.92	0.92	0.92	0.92	0.92	0.92	0.92	0.92
Hourly flow rate (vph)	7	16	285	126	32	12	103	141	47	12	474	22
Pedestrians												
Lane Width (m)												
Walking Speed (m/s)												
Percent Blockage												
Right turn flare (veh)												
Median type												
Median storage veh												
Upstream signal (m)												
pX, platoon unblocked												
vC, conflicting volume	872	856	485	996	867	141	496			141		
vC1, stage 1 conf vol												
vC2, stage 2 conf vol												
vCu, unblocked vol	872	856	485	996	867	141	496			141		
tC, single (s)	7.1	6.5	6.2	7.1	6.5	6.2	4.1			4.1		
tC, 2 stage (s)												
tF (s)	3.5	4.0	3.3	3.5	4.0	3.3	2.2			2.2		
p0 queue free %	97	94	51	0	88	99	90			99		
cM capacity (veh/h)	223	264	582	100	261	907	1068			1442		
Direction, Lane #	EB 1	WB 1	NB 1	NB 2	NB 3	SB 1	SB 2					
Volume Total	308	170	103	141	47	12	496					
Volume Left	7	126	103	0	0	12	0					
Volume Right	285	12	0	0	47	0	22					
cSH	629	122	1068	1700	1700	1442	1700					
Volume to Capacity	0.49	1.39	0.10	0.08	0.03	0.01	0.29					
Queue Length 95th (m)	21.6	92.2	2.6	0.0	0.0	0.2	0.0					
Control Delay (s)	17.3	285.4	8.7	0.0	0.0	7.5	0.0					
Lane LOS	C	F	A			A						
Approach Delay (s)	17.3	285.4	3.1			0.2						
Approach LOS	C	F										
Intersection Summary												
Average Delay			42.9									
Intersection Capacity Utilization			59.0%		ICU Level of Service				B			
Analysis Period (min)			15									

Cooper Blvd Corridor Study
4: Cooper Blvd & Memorial Dr

2030 Projected Conditions
Timing Plan: AM Peak

												
Movement	EBL	EBT	EBR	WBL	WBT	WBR	NBL	NBT	NBR	SBL	SBT	SBR
Lane Configurations												
Traffic Volume (veh/h)	13	30	181	66	11	10	99	289	82	38	888	22
Future Volume (Veh/h)	13	30	181	66	11	10	99	289	82	38	888	22
Sign Control		Stop			Stop			Free			Free	
Grade		0%			0%			0%			0%	
Peak Hour Factor	0.92	0.92	0.92	0.92	0.92	0.92	0.92	0.92	0.92	0.92	0.92	0.92
Hourly flow rate (vph)	14	33	197	72	12	11	108	314	89	41	965	24
Pedestrians												
Lane Width (m)												
Walking Speed (m/s)												
Percent Blockage												
Right turn flare (veh)												
Median type												
Median storage veh												
Upstream signal (m)												
pX, platoon unblocked												
vC, conflicting volume	1595	1589	977	1638	1646	358	989			314		
vC1, stage 1 conf vol												
vC2, stage 2 conf vol												
vCu, unblocked vol	1595	1589	977	1638	1646	358	989			314		
tC, single (s)	7.1	6.5	6.2	7.1	6.5	6.2	4.1			4.1		
tC, 2 stage (s)												
tF (s)	3.5	4.0	3.3	3.5	4.0	3.3	2.2			2.2		
p0 queue free %	78	63	35	0	85	98	85			97		
cM capacity (veh/h)	65	88	304	17	81	686	699			1246		
Direction, Lane #	EB 1	WB 1	NB 1	NB 2	SB 1	SB 2						
Volume Total	244	95	108	403	41	989						
Volume Left	14	72	108	0	41	0						
Volume Right	197	11	0	89	0	24						
cSH	197	22	699	1700	1246	1700						
Volume to Capacity	1.24	4.29	0.15	0.24	0.03	0.58						
Queue Length 95th (m)	103.5	Err	4.4	0.0	0.8	0.0						
Control Delay (s)	191.0	Err	11.1	0.0	8.0	0.0						
Lane LOS	F	F	B		A							
Approach Delay (s)	191.0	Err	2.3		0.3							
Approach LOS	F	F										
Intersection Summary												
Average Delay			530.9									
Intersection Capacity Utilization			85.2%		ICU Level of Service					E		
Analysis Period (min)			15									

Cooper Blvd Corridor Study
5: Cooper Blvd & Roe Ave

2030 Projected Conditions
Timing Plan: AM Peak

Lane Group	EBL	EBT	EBR	WBL	WBT	WBR	NBL	NBT	NBR	SBL	SBT	SBR
Lane Configurations												
Traffic Volume (vph)	32	160	73	90	87	72	68	264	109	203	710	74
Future Volume (vph)	32	160	73	90	87	72	68	264	109	203	710	74
Satd. Flow (prot)	1770	1863	1583	1770	1863	1583	1770	1863	1583	1770	1863	1583
Flt Permitted	0.695			0.466			0.083			0.430		
Satd. Flow (perm)	1295	1863	1583	868	1863	1583	155	1863	1583	801	1863	1583
Satd. Flow (RTOR)			126			126			126			126
Lane Group Flow (vph)	35	174	79	98	95	78	74	287	118	221	772	80
Turn Type	pm+pt	NA	Perm	pm+pt	NA	Perm	pm+pt	NA	Perm	pm+pt	NA	Perm
Protected Phases	7	4		3	8		5	2		1	6	
Permitted Phases	4		4	8		8	2		2	6		6
Total Split (s)	20.0	34.0	34.0	25.0	39.0	39.0	16.0	53.0	53.0	18.0	55.0	55.0
Total Lost Time (s)	6.0	6.0	6.0	6.0	6.0	6.0	6.0	6.0	6.0	6.0	6.0	6.0
Act Effct Green (s)	42.0	28.0	28.0	44.4	36.0	36.0	55.1	47.0	47.0	62.5	53.0	53.0
Actuated g/C Ratio	0.34	0.22	0.22	0.36	0.29	0.29	0.44	0.38	0.38	0.50	0.43	0.43
v/c Ratio	0.07	0.42	0.17	0.24	0.18	0.14	0.43	0.41	0.17	0.45	0.97	0.11
Control Delay	24.9	45.0	2.2	26.9	38.0	1.8	24.1	30.9	4.4	19.9	63.0	1.2
Queue Delay	0.0	0.0	0.0	0.0	0.0	0.0	0.0	0.0	0.0	0.0	0.0	0.0
Total Delay	24.9	45.0	2.2	26.9	38.0	1.8	24.1	30.9	4.4	19.9	63.0	1.2
LOS	C	D	A	C	D	A	C	C	A	B	E	A
Approach Delay		30.8			23.6			23.3			49.5	
Approach LOS		C			C			C			D	
Queue Length 50th (m)	5.6	38.8	0.0	16.4	20.3	0.0	9.3	54.3	0.0	30.3	~211.3	0.0
Queue Length 95th (m)	12.9	61.4	3.1	29.1	36.1	2.9	17.9	79.7	11.2	46.4	#295.8	2.7
Internal Link Dist (m)		98.9			80.2			211.7			510.5	
Turn Bay Length (m)	48.0		10.0	40.0		62.0	97.0		50.0	54.0		50.0
Base Capacity (vph)	490	418	453	467	583	582	200	702	675	495	792	745
Starvation Cap Reductn	0	0	0	0	0	0	0	0	0	0	0	0
Spillback Cap Reductn	0	0	0	0	0	0	0	0	0	0	0	0
Storage Cap Reductn	0	0	0	0	0	0	0	0	0	0	0	0
Reduced v/c Ratio	0.07	0.42	0.17	0.21	0.16	0.13	0.37	0.41	0.17	0.45	0.97	0.11

Intersection Summary

Cycle Length: 130
 Actuated Cycle Length: 124.6
 Control Type: Actuated-Uncoordinated
 Maximum v/c Ratio: 0.97
 Intersection Signal Delay: 37.7
 Intersection LOS: D
 Intersection Capacity Utilization 96.1%
 ICU Level of Service F
 Analysis Period (min) 15
 ~ Volume exceeds capacity, queue is theoretically infinite.
 Queue shown is maximum after two cycles.
 # 95th percentile volume exceeds capacity, queue may be longer.
 Queue shown is maximum after two cycles.

Splits and Phases: 5: Cooper Blvd & Roe Ave

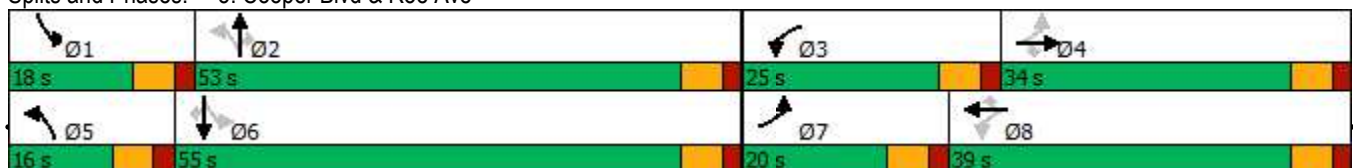



Movement	WBL	WBR	NBT	NBR	SBL	SBT
Lane Configurations						
Traffic Volume (veh/h)	96	160	332	282	271	655
Future Volume (Veh/h)	96	160	332	282	271	655
Sign Control	Stop		Free		Free	
Grade	0%		0%		0%	
Peak Hour Factor	0.92	0.92	0.92	0.92	0.92	0.92
Hourly flow rate (vph)	104	174	361	307	295	712
Pedestrians						
Lane Width (m)						
Walking Speed (m/s)						
Percent Blockage						
Right turn flare (veh)	3					
Median type			None		None	
Median storage (veh)						
Upstream signal (m)	236					
pX, platoon unblocked	0.63					
vC, conflicting volume	1816	514			668	
vC1, stage 1 conf vol						
vC2, stage 2 conf vol						
vCu, unblocked vol	2005	514			668	
tC, single (s)	6.4	6.2			4.1	
tC, 2 stage (s)						
tF (s)	3.5	3.3			2.2	
p0 queue free %	0	69			68	
cM capacity (veh/h)	28	560			922	
Direction, Lane #	WB 1	NB 1	SB 1	SB 2		
Volume Total	278	668	295	712		
Volume Left	104	0	295	0		
Volume Right	174	307	0	0		
cSH	69	1700	922	1700		
Volume to Capacity	4.02	0.39	0.32	0.42		
Queue Length 95th (m)	Err	0.0	11.1	0.0		
Control Delay (s)	Err	0.0	10.7	0.0		
Lane LOS	F		B			
Approach Delay (s)	Err	0.0	3.1			
Approach LOS	F					
Intersection Summary						
Average Delay			1424.9			
Intersection Capacity Utilization			65.0%		ICU Level of Service C	
Analysis Period (min)	15					

Cooper Blvd Corridor Study
7: Cooper Blvd & Airport Blvd

2030 Projected Conditions
Timing Plan: AM Peak

Lane Group	EBL	EBT	EBR	WBL	WBT	WBR	NBL	NBT	NBR	SBL	SBT	SBR
Lane Configurations												
Traffic Volume (vph)	239	165	43	14	126	64	64	319	26	102	331	284
Future Volume (vph)	239	165	43	14	126	64	64	319	26	102	331	284
Satd. Flow (prot)	1770	1805	0	1770	1768	0	1770	1842	0	1770	1734	0
Flt Permitted	0.407			0.617			0.113			0.392		
Satd. Flow (perm)	758	1805	0	1149	1768	0	210	1842	0	730	1734	0
Satd. Flow (RTOR)		12			23			4			44	
Lane Group Flow (vph)	260	226	0	15	207	0	70	375	0	111	669	0
Turn Type	pm+pt	NA		pm+pt	NA		pm+pt	NA		pm+pt	NA	
Protected Phases	7	4		3	8		5	2		1	6	
Permitted Phases	4			8			2			6		
Total Split (s)	12.0	32.0		10.0	30.0		22.0	41.0		22.0	41.0	
Total Lost Time (s)	6.0	6.0		6.0	6.0		6.0	6.0		6.0	6.0	
Act Effct Green (s)	26.2	25.1		18.8	14.7		41.4	35.5		43.3	36.4	
Actuated g/C Ratio	0.30	0.29		0.22	0.17		0.48	0.41		0.50	0.42	
v/c Ratio	0.86	0.42		0.05	0.64		0.29	0.49		0.23	0.88	
Control Delay	55.4	28.0		22.3	40.0		13.7	23.3		11.4	38.7	
Queue Delay	0.0	0.0		0.0	0.0		0.0	0.0		0.0	0.0	
Total Delay	55.4	28.0		22.3	40.0		13.7	23.3		11.4	38.7	
LOS	E	C		C	D		B	C		B	D	
Approach Delay		42.7			38.8			21.8			34.8	
Approach LOS		D			D			C			C	
Queue Length 50th (m)	37.4	29.8		1.9	30.8		5.3	48.1		8.5	102.1	
Queue Length 95th (m)	#84.3	60.4		6.5	55.1		13.2	87.9		19.0	#200.1	
Internal Link Dist (m)		87.0			101.4			173.0			438.1	
Turn Bay Length (m)	21.0			50.0			78.0			82.0		
Base Capacity (vph)	302	575		280	516		408	762		594	759	
Starvation Cap Reductn	0	0		0	0		0	0		0	0	
Spillback Cap Reductn	0	0		0	0		0	0		0	0	
Storage Cap Reductn	0	0		0	0		0	0		0	0	
Reduced v/c Ratio	0.86	0.39		0.05	0.40		0.17	0.49		0.19	0.88	

Intersection Summary

Cycle Length: 105

Actuated Cycle Length: 86

Control Type: Actuated-Uncoordinated

Maximum v/c Ratio: 0.88

Intersection Signal Delay: 34.2

Intersection LOS: C

Intersection Capacity Utilization 84.4%

ICU Level of Service E

Analysis Period (min) 15

95th percentile volume exceeds capacity, queue may be longer.

Queue shown is maximum after two cycles.

Splits and Phases: 7: Cooper Blvd & Airport Blvd

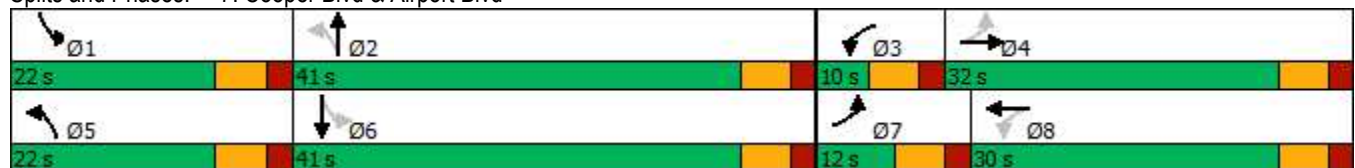

Cooper Blvd Corridor Study
8: Cooper Blvd & Laurel Rd

2030 Projected Conditions
Timing Plan: AM Peak



Movement	EBL	EBR	NBL	NBT	SBT	SBR
Lane Configurations						
Traffic Volume (veh/h)	67	23	32	317	225	136
Future Volume (Veh/h)	67	23	32	317	225	136
Sign Control	Stop			Free	Free	
Grade	0%			0%	0%	
Peak Hour Factor	0.92	0.92	0.92	0.92	0.92	0.92
Hourly flow rate (vph)	73	25	35	345	245	148
Pedestrians						
Lane Width (m)						
Walking Speed (m/s)						
Percent Blockage						
Right turn flare (veh)						
Median type				None	None	
Median storage veh						
Upstream signal (m)					197	
pX, platoon unblocked						
vC, conflicting volume	660	245	245			
vC1, stage 1 conf vol						
vC2, stage 2 conf vol						
vCu, unblocked vol	660	245	245			
tC, single (s)	6.4	6.2	4.1			
tC, 2 stage (s)						
tF (s)	3.5	3.3	2.2			
p0 queue free %	82	97	97			
cM capacity (veh/h)	417	794	1321			
Direction, Lane #	EB 1	NB 1	NB 2	SB 1	SB 2	
Volume Total	98	35	345	245	148	
Volume Left	73	35	0	0	0	
Volume Right	25	0	0	0	148	
cSH	474	1321	1700	1700	1700	
Volume to Capacity	0.21	0.03	0.20	0.14	0.09	
Queue Length 95th (m)	6.2	0.7	0.0	0.0	0.0	
Control Delay (s)	14.6	7.8	0.0	0.0	0.0	
Lane LOS	B	A				
Approach Delay (s)	14.6	0.7		0.0		
Approach LOS	B					
Intersection Summary						
Average Delay			2.0			
Intersection Capacity Utilization			30.3%	ICU Level of Service	A	
Analysis Period (min)			15			













Movement	EBL	EBT	WBT	WBR	SBL	SBR
Lane Configurations						
Traffic Volume (veh/h)	319	65	93	173	86	195
Future Volume (Veh/h)	319	65	93	173	86	195
Sign Control		Free	Free		Stop	
Grade		0%	0%		0%	
Peak Hour Factor	0.92	0.92	0.92	0.92	0.92	0.92
Hourly flow rate (vph)	347	71	101	188	93	212
Pedestrians						
Lane Width (m)						
Walking Speed (m/s)						
Percent Blockage						
Right turn flare (veh)						
Median type		None	None			
Median storage (veh)						
Upstream signal (m)						
pX, platoon unblocked						
vC, conflicting volume	101				866	101
vC1, stage 1 conf vol						
vC2, stage 2 conf vol						
vCu, unblocked vol	101				866	101
tC, single (s)	4.1				6.4	6.2
tC, 2 stage (s)						
tF (s)	2.2				3.5	3.3
p0 queue free %	77				63	78
cM capacity (veh/h)	1491				248	954
Direction, Lane #	EB 1	EB 2	WB 1	WB 2	SB 1	
Volume Total	347	71	101	188	305	
Volume Left	347	0	0	0	93	
Volume Right	0	0	0	188	212	
cSH	1491	1700	1700	1700	511	
Volume to Capacity	0.23	0.04	0.06	0.11	0.60	
Queue Length 95th (m)	7.2	0.0	0.0	0.0	30.9	
Control Delay (s)	8.1	0.0	0.0	0.0	21.9	
Lane LOS	A				C	
Approach Delay (s)	6.8		0.0		21.9	
Approach LOS					C	
Intersection Summary						
Average Delay			9.4			
Intersection Capacity Utilization			47.8%		ICU Level of Service	A
Analysis Period (min)			15			

Cooper Blvd Corridor Study
1: Cooper Blvd & Magee Rd

2030 Projected Conditions
Timing Plan: PM Peak



Movement	EBL	EBR	NBL	NBT	SBT	SBR
Lane Configurations						
Traffic Volume (veh/h)	38	117	157	256	146	9
Future Volume (Veh/h)	38	117	157	256	146	9
Sign Control	Stop			Free	Free	
Grade	0%			0%	0%	
Peak Hour Factor	0.92	0.92	0.92	0.92	0.92	0.92
Hourly flow rate (vph)	41	127	171	278	159	10
Pedestrians						
Lane Width (m)						
Walking Speed (m/s)						
Percent Blockage						
Right turn flare (veh)						
Median type				None	None	
Median storage (veh)						
Upstream signal (m)						
pX, platoon unblocked						
vC, conflicting volume	784	164	169			
vC1, stage 1 conf vol						
vC2, stage 2 conf vol						
vCu, unblocked vol	784	164	169			
tC, single (s)	6.4	6.2	4.1			
tC, 2 stage (s)						
tF (s)	3.5	3.3	2.2			
p0 queue free %	87	86	88			
cM capacity (veh/h)	318	881	1409			
Direction, Lane #	EB 1	NB 1	NB 2	SB 1		
Volume Total	168	171	278	169		
Volume Left	41	171	0	0		
Volume Right	127	0	0	10		
cSH	615	1409	1700	1700		
Volume to Capacity	0.27	0.12	0.16	0.10		
Queue Length 95th (m)	8.8	3.3	0.0	0.0		
Control Delay (s)	13.0	7.9	0.0	0.0		
Lane LOS	B	A				
Approach Delay (s)	13.0	3.0	0.0			
Approach LOS	B					
Intersection Summary						
Average Delay	4.5					
Intersection Capacity Utilization	36.2%			ICU Level of Service	A	
Analysis Period (min)	15					





















						
Movement	WBL	WBR	NBT	NBR	SBL	SBT
Lane Configurations						
Traffic Volume (veh/h)	27	12	390	44	15	236
Future Volume (Veh/h)	27	12	390	44	15	236
Sign Control	Stop		Free			Free
Grade	0%		0%			0%
Peak Hour Factor	0.92	0.92	0.92	0.92	0.92	0.92
Hourly flow rate (vph)	29	13	424	48	16	257
Pedestrians						
Lane Width (m)						
Walking Speed (m/s)						
Percent Blockage						
Right turn flare (veh)						
Median type			None			None
Median storage veh						
Upstream signal (m)						
pX, platoon unblocked						
vC, conflicting volume	713	424			424	
vC1, stage 1 conf vol						
vC2, stage 2 conf vol						
vCu, unblocked vol	713	424			424	
tC, single (s)	6.4	6.2			4.1	
tC, 2 stage (s)						
tF (s)	3.5	3.3			2.2	
p0 queue free %	93	98			99	
cM capacity (veh/h)	393	630			1135	
Direction, Lane #	WB 1	NB 1	NB 2	SB 1	SB 2	
Volume Total	42	424	48	16	257	
Volume Left	29	0	0	16	0	
Volume Right	13	0	48	0	0	
cSH	445	1700	1700	1135	1700	
Volume to Capacity	0.09	0.25	0.03	0.01	0.15	
Queue Length 95th (m)	2.5	0.0	0.0	0.3	0.0	
Control Delay (s)	13.9	0.0	0.0	8.2	0.0	
Lane LOS	B			A		
Approach Delay (s)	13.9	0.0		0.5		
Approach LOS	B					
Intersection Summary						
Average Delay			0.9			
Intersection Capacity Utilization			30.5%		ICU Level of Service	A
Analysis Period (min)			15			



Movement	EBL	EBR	NBL	NBT	SBT	SBR
Lane Configurations						
Traffic Volume (veh/h)	10	88	45	411	258	5
Future Volume (Veh/h)	10	88	45	411	258	5
Sign Control	Stop			Free	Free	
Grade	0%			0%	0%	
Peak Hour Factor	0.92	0.92	0.92	0.92	0.92	0.92
Hourly flow rate (vph)	11	96	49	447	280	5
Pedestrians						
Lane Width (m)						
Walking Speed (m/s)						
Percent Blockage						
Right turn flare (veh)						
Median type				None	None	
Median storage (veh)						
Upstream signal (m)						
pX, platoon unblocked						
vC, conflicting volume	828	282	285			
vC1, stage 1 conf vol						
vC2, stage 2 conf vol						
vCu, unblocked vol	828	282	285			
tC, single (s)	6.4	6.2	4.1			
tC, 2 stage (s)						
tF (s)	3.5	3.3	2.2			
p0 queue free %	97	87	96			
cM capacity (veh/h)	328	756	1277			
Direction, Lane #	EB 1	NB 1	SB 1			
Volume Total	107	496	285			
Volume Left	11	49	0			
Volume Right	96	0	5			
cSH	667	1277	1700			
Volume to Capacity	0.16	0.04	0.17			
Queue Length 95th (m)	4.5	1.0	0.0			
Control Delay (s)	11.4	1.2	0.0			
Lane LOS	B	A				
Approach Delay (s)	11.4	1.2	0.0			
Approach LOS	B					
Intersection Summary						
Average Delay			2.0			
Intersection Capacity Utilization			54.0%	ICU Level of Service	A	
Analysis Period (min)			15			



















Cooper Blvd Corridor Study
3: Cooper Blvd & Raynham Ave

2030 Projected Conditions
Timing Plan: PM Peak

												
Movement	EBL	EBT	EBR	WBL	WBT	WBR	NBL	NBT	NBR	SBL	SBT	SBR
Lane Configurations												
Traffic Volume (veh/h)	12	45	130	75	27	13	308	431	128	8	255	33
Future Volume (Veh/h)	12	45	130	75	27	13	308	431	128	8	255	33
Sign Control		Stop			Stop			Free			Free	
Grade		0%			0%			0%			0%	
Peak Hour Factor	0.92	0.92	0.92	0.92	0.92	0.92	0.92	0.92	0.92	0.92	0.92	0.92
Hourly flow rate (vph)	13	49	141	82	29	14	335	468	139	9	277	36
Pedestrians												
Lane Width (m)												
Walking Speed (m/s)												
Percent Blockage												
Right turn flare (veh)												
Median type												
Median storage veh												
Upstream signal (m)												
pX, platoon unblocked												
vC, conflicting volume	1466	1451	295	1528	1469	468	313			468		
vC1, stage 1 conf vol												
vC2, stage 2 conf vol												
vCu, unblocked vol	1466	1451	295	1528	1469	468	313			468		
tC, single (s)	7.1	6.5	6.2	7.1	6.5	6.2	4.1			4.1		
tC, 2 stage (s)												
tF (s)	3.5	4.0	3.3	3.5	4.0	3.3	2.2			2.2		
p0 queue free %	79	48	81	0	69	98	73			99		
cM capacity (veh/h)	63	95	744	37	92	595	1247			1094		
Direction, Lane #	EB 1	WB 1	NB 1	NB 2	NB 3	SB 1	SB 2					
Volume Total	203	125	335	468	139	9	313					
Volume Left	13	82	335	0	0	9	0					
Volume Right	141	14	0	0	139	0	36					
cSH	244	49	1247	1700	1700	1094	1700					
Volume to Capacity	0.83	2.54	0.27	0.28	0.08	0.01	0.18					
Queue Length 95th (m)	52.2	104.5	8.7	0.0	0.0	0.2	0.0					
Control Delay (s)	65.2	876.3	8.9	0.0	0.0	8.3	0.0					
Lane LOS	F	F	A			A						
Approach Delay (s)	65.2	876.3	3.2			0.2						
Approach LOS	F	F										
Intersection Summary												
Average Delay			79.0									
Intersection Capacity Utilization			55.5%		ICU Level of Service				B			
Analysis Period (min)			15									

Cooper Blvd Corridor Study
4: Cooper Blvd & Memorial Dr

2030 Projected Conditions
Timing Plan: PM Peak

												
Movement	EBL	EBT	EBR	WBL	WBT	WBR	NBL	NBT	NBR	SBL	SBT	SBR
Lane Configurations												
Traffic Volume (veh/h)	21	15	155	70	24	27	235	941	84	18	519	11
Future Volume (Veh/h)	21	15	155	70	24	27	235	941	84	18	519	11
Sign Control		Stop			Stop			Free			Free	
Grade		0%			0%			0%			0%	
Peak Hour Factor	0.92	0.92	0.92	0.92	0.92	0.92	0.92	0.92	0.92	0.92	0.92	0.92
Hourly flow rate (vph)	23	16	168	76	26	29	255	1023	91	20	564	12
Pedestrians												
Lane Width (m)												
Walking Speed (m/s)												
Percent Blockage												
Right turn flare (veh)												
Median type												
Median storage veh												
Upstream signal (m)												
pX, platoon unblocked												
vC, conflicting volume	2156	2143	570	2190	2194	1068	576			1023		
vC1, stage 1 conf vol												
vC2, stage 2 conf vol												
vCu, unblocked vol	2156	2143	570	2190	2194	1068	576			1023		
tC, single (s)	7.1	6.5	6.2	7.1	6.5	6.2	4.1			4.1		
tC, 2 stage (s)												
tF (s)	3.5	4.0	3.3	3.5	4.0	3.3	2.2			2.2		
p0 queue free %	0	54	68	0	20	89	74			97		
cM capacity (veh/h)	9	35	521	11	33	269	997			679		
Direction, Lane #	EB 1	WB 1	NB 1	NB 2	SB 1	SB 2						
Volume Total	207	131	255	1114	20	576						
Volume Left	23	76	255	0	20	0						
Volume Right	168	29	0	91	0	12						
cSH	60	17	997	1700	679	1700						
Volume to Capacity	3.46	7.57	0.26	0.66	0.03	0.34						
Queue Length 95th (m)	Err	Err	8.2	0.0	0.7	0.0						
Control Delay (s)	Err	Err	9.8	0.0	10.5	0.0						
Lane LOS	F	F	A		B							
Approach Delay (s)	Err	Err	1.8		0.4							
Approach LOS	F	F										
Intersection Summary												
Average Delay			1468.7									
Intersection Capacity Utilization			89.6%		ICU Level of Service					E		
Analysis Period (min)			15									

Cooper Blvd Corridor Study
5: Cooper Blvd & Roe Ave

2030 Projected Conditions
Timing Plan: PM Peak

Lane Group	EBL	EBT	EBR	WBL	WBT	WBR	NBL	NBT	NBR	SBL	SBT	SBR
Lane Configurations												
Traffic Volume (vph)	110	156	57	299	220	270	79	750	70	109	427	25
Future Volume (vph)	110	156	57	299	220	270	79	750	70	109	427	25
Satd. Flow (prot)	1770	1863	1583	1770	1863	1583	1770	1863	1583	1770	1863	1583
Flt Permitted	0.504			0.449			0.258			0.079		
Satd. Flow (perm)	939	1863	1583	836	1863	1583	481	1863	1583	147	1863	1583
Satd. Flow (RTOR)			143			259			101			143
Lane Group Flow (vph)	120	170	62	325	239	293	86	815	76	118	464	27
Turn Type	pm+pt	NA	Perm	pm+pt	NA	Perm	pm+pt	NA	Perm	pm+pt	NA	Perm
Protected Phases	7	4		3	8		5	2		1	6	
Permitted Phases	4		4	8		8	2		2	6		6
Total Split (s)	20.0	34.0	34.0	25.0	39.0	39.0	16.0	61.0	61.0	10.0	55.0	55.0
Total Lost Time (s)	5.0	5.0	5.0	5.0	5.0	5.0	5.0	5.0	5.0	5.0	5.0	5.0
Act Effct Green (s)	42.2	28.0	28.0	51.1	32.8	32.8	66.0	56.0	56.0	55.8	50.8	50.8
Actuated g/C Ratio	0.33	0.22	0.22	0.40	0.26	0.26	0.52	0.44	0.44	0.44	0.40	0.40
v/c Ratio	0.30	0.42	0.14	0.69	0.50	0.49	0.25	1.00	0.10	0.93	0.63	0.04
Control Delay	26.8	47.0	0.6	36.3	44.8	9.9	17.9	67.9	2.2	87.7	35.9	0.1
Queue Delay	0.0	0.0	0.0	0.0	0.0	0.0	0.0	0.0	0.0	0.0	0.0	0.0
Total Delay	26.8	47.0	0.6	36.3	44.8	9.9	17.9	67.9	2.2	87.7	35.9	0.1
LOS	C	D	A	D	D	A	B	E	A	F	D	A
Approach Delay		31.9			29.6			58.4			44.3	
Approach LOS		C			C			E			D	
Queue Length 50th (m)	20.0	39.5	0.0	61.9	54.2	6.9	11.5	~218.9	0.0	16.1	98.9	0.0
Queue Length 95th (m)	33.9	62.4	0.0	89.5	81.8	32.5	20.8	#307.2	5.5	#55.5	138.8	0.0
Internal Link Dist (m)		98.9			80.2			211.7			510.5	
Turn Bay Length (m)	48.0		10.0	40.0		62.0	97.0		50.0	54.0		50.0
Base Capacity (vph)	413	422	469	485	495	610	359	815	749	127	739	714
Starvation Cap Reductn	0	0	0	0	0	0	0	0	0	0	0	0
Spillback Cap Reductn	0	0	0	0	0	0	0	0	0	0	0	0
Storage Cap Reductn	0	0	0	0	0	0	0	0	0	0	0	0
Reduced v/c Ratio	0.29	0.40	0.13	0.67	0.48	0.48	0.24	1.00	0.10	0.93	0.63	0.04

Intersection Summary

Cycle Length: 130

Actuated Cycle Length: 127.9

Control Type: Actuated-Uncoordinated

Maximum v/c Ratio: 1.00

Intersection Signal Delay: 43.2

Intersection LOS: D

Intersection Capacity Utilization 102.1%

ICU Level of Service G

Analysis Period (min) 15

~ Volume exceeds capacity, queue is theoretically infinite.









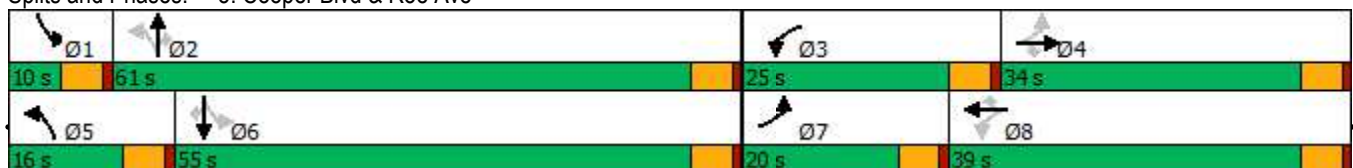

Queue shown is maximum after two cycles.

95th percentile volume exceeds capacity, queue may be longer.

Queue shown is maximum after two cycles.

Splits and Phases: 5: Cooper Blvd & Roe Ave



						
Movement	WBL	WBR	NBT	NBR	SBL	SBT
Lane Configurations						
Traffic Volume (veh/h)	238	301	719	265	192	550
Future Volume (Veh/h)	238	301	719	265	192	550
Sign Control	Stop		Free		Free	
Grade	0%		0%		0%	
Peak Hour Factor	0.92	0.92	0.92	0.92	0.92	0.92
Hourly flow rate (vph)	259	327	782	288	209	598
Pedestrians						
Lane Width (m)						
Walking Speed (m/s)						
Percent Blockage						
Right turn flare (veh)	3					
Median type	None			None		
Median storage veh						
Upstream signal (m)	236					
pX, platoon unblocked	0.72					
vC, conflicting volume	1942	926	1070			
vC1, stage 1 conf vol						
vC2, stage 2 conf vol						
vCu, unblocked vol	2115	926	1070			
tC, single (s)	6.4	6.2	4.1			
tC, 2 stage (s)						
tF (s)	3.5	3.3	2.2			
p0 queue free %	0	0	68			
cM capacity (veh/h)	27	326	651			
Direction, Lane #	WB 1	NB 1	SB 1	SB 2		
Volume Total	586	1070	209	598		
Volume Left	259	0	209	0		
Volume Right	327	288	0	0		
cSH	56	1700	651	1700		
Volume to Capacity	10.52	0.63	0.32	0.35		
Queue Length 95th (m)	Err	0.0	11.1	0.0		
Control Delay (s)	Err	0.0	13.1	0.0		
Lane LOS	F		B			
Approach Delay (s)	Err	0.0	3.4			
Approach LOS	F					
Intersection Summary						
Average Delay	2380.1					
Intersection Capacity Utilization	87.8%			ICU Level of Service		E
Analysis Period (min)	15					

Cooper Blvd Corridor Study
7: Cooper Blvd & Airport Blvd

2030 Projected Conditions
Timing Plan: PM Peak



Lane Group	EBL	EBT	EBR	WBL	WBT	WBR	NBL	NBT	NBR	SBL	SBT	SBR
Lane Configurations	↖	↗		↖	↗		↖	↗		↖	↗	
Traffic Volume (vph)	321	144	61	29	282	204	40	423	14	98	430	353
Future Volume (vph)	321	144	61	29	282	204	40	423	14	98	430	353
Satd. Flow (prot)	1770	1781	0	1770	1745	0	1770	1853	0	1770	1736	0
Flt Permitted	0.096			0.619			0.071			0.255		
Satd. Flow (perm)	179	1781	0	1153	1745	0	132	1853	0	475	1736	0
Satd. Flow (RTOR)		15			23			1			33	
Lane Group Flow (vph)	349	223	0	32	529	0	43	475	0	107	851	0
Turn Type	pm+pt	NA		pm+pt	NA		pm+pt	NA		pm+pt	NA	
Protected Phases	7	4		3	8		5	2		1	6	
Permitted Phases	4			8			2			6		
Total Split (s)	23.0	52.0		10.0	39.0		22.0	61.0		22.0	61.0	
Total Lost Time (s)	6.0	6.0		6.0	6.0		6.0	6.0		6.0	6.0	
Act Effct Green (s)	56.0	50.1		37.0	33.0		62.6	55.0		68.6	60.2	
Actuated g/C Ratio	0.40	0.36		0.27	0.24		0.45	0.40		0.49	0.43	
v/c Ratio	1.31	0.34		0.10	1.23		0.29	0.65		0.33	1.11	
Control Delay	198.3	33.4		28.0	163.6		22.6	39.4		20.5	102.0	
Queue Delay	0.0	0.0		0.0	0.0		0.0	0.0		0.0	0.0	
Total Delay	198.3	33.4		28.0	163.6		22.6	39.4		20.5	102.0	
LOS	F	C		C	F		C	D		C	F	
Approach Delay		134.0			155.8			38.0			92.9	
Approach LOS		F			F			D			F	
Queue Length 50th (m)	~114.4	45.7		5.6	~182.9		6.1	110.3		15.7	~283.0	
Queue Length 95th (m)	#184.2	71.6		13.1	#263.6		12.6	155.1		26.6	#372.1	
Internal Link Dist (m)		87.0			101.4			173.0			438.1	
Turn Bay Length (m)	21.0			50.0			78.0			82.0		
Base Capacity (vph)	266	650		324	431		255	733		391	769	
Starvation Cap Reductn	0	0		0	0		0	0		0	0	
Spillback Cap Reductn	0	0		0	0		0	0		0	0	
Storage Cap Reductn	0	0		0	0		0	0		0	0	
Reduced v/c Ratio	1.31	0.34		0.10	1.23		0.17	0.65		0.27	1.11	

Intersection Summary

Cycle Length: 145

Actuated Cycle Length: 139.1

Control Type: Actuated-Uncoordinated

Maximum v/c Ratio: 1.31

Intersection Signal Delay: 104.5

Intersection LOS: F

Intersection Capacity Utilization 115.1%

ICU Level of Service H

Analysis Period (min) 15

~ Volume exceeds capacity, queue is theoretically infinite.

Queue shown is maximum after two cycles.

95th percentile volume exceeds capacity, queue may be longer.

Queue shown is maximum after two cycles.

Splits and Phases: 7: Cooper Blvd & Airport Blvd

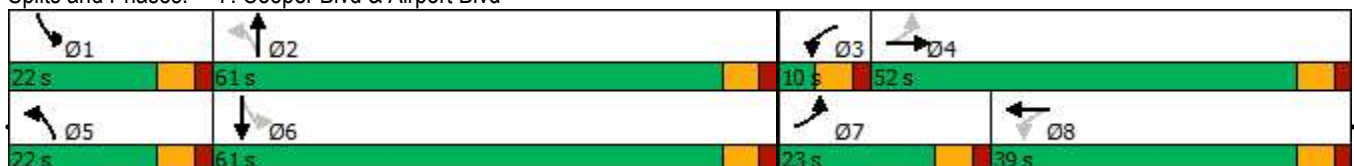





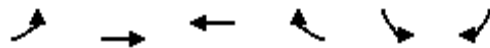







Movement	EBL	EBR	NBL	NBT	SBT	SBR
Lane Configurations						
Traffic Volume (veh/h)	232	72	42	322	517	184
Future Volume (Veh/h)	232	72	42	322	517	184
Sign Control	Stop			Free	Free	
Grade	0%			0%	0%	
Peak Hour Factor	0.92	0.92	0.92	0.92	0.92	0.92
Hourly flow rate (vph)	252	78	46	350	562	200
Pedestrians						
Lane Width (m)						
Walking Speed (m/s)						
Percent Blockage						
Right turn flare (veh)						
Median type				None	None	
Median storage (veh)						
Upstream signal (m)						197
pX, platoon unblocked						
vC, conflicting volume	1004	562	562			
vC1, stage 1 conf vol						
vC2, stage 2 conf vol						
vCu, unblocked vol	1004	562	562			
tC, single (s)	6.4	6.2	4.1			
tC, 2 stage (s)						
tF (s)	3.5	3.3	2.2			
p0 queue free %	1	85	95			
cM capacity (veh/h)	256	526	1009			
Direction, Lane #	EB 1	NB 1	NB 2	SB 1	SB 2	
Volume Total	330	46	350	562	200	
Volume Left	252	46	0	0	0	
Volume Right	78	0	0	0	200	
cSH	291	1009	1700	1700	1700	
Volume to Capacity	1.13	0.05	0.21	0.33	0.12	
Queue Length 95th (m)	110.5	1.1	0.0	0.0	0.0	
Control Delay (s)	132.2	8.7	0.0	0.0	0.0	
Lane LOS	F	A				
Approach Delay (s)	132.2	1.0		0.0		
Approach LOS	F					
Intersection Summary						
Average Delay			29.6			
Intersection Capacity Utilization			57.8%	ICU Level of Service	B	
Analysis Period (min)			15			



Movement	EBL	EBT	WBT	WBR	SBL	SBR
Lane Configurations						
Traffic Volume (veh/h)	342	130	101	181	278	527
Future Volume (Veh/h)	342	130	101	181	278	527
Sign Control		Free	Free		Stop	
Grade		0%	0%		0%	
Peak Hour Factor	0.92	0.92	0.92	0.92	0.92	0.92
Hourly flow rate (vph)	372	141	110	197	302	573
Pedestrians						
Lane Width (m)						
Walking Speed (m/s)						
Percent Blockage						
Right turn flare (veh)						
Median type		None	None			
Median storage (veh)						
Upstream signal (m)						
pX, platoon unblocked						
vC, conflicting volume	110				995	110
vC1, stage 1 conf vol						
vC2, stage 2 conf vol						
vCu, unblocked vol	110				995	110
tC, single (s)	4.1				6.4	6.2
tC, 2 stage (s)						
tF (s)	2.2				3.5	3.3
p0 queue free %	75				0	39
cM capacity (veh/h)	1480				203	943
Direction, Lane #	EB 1	EB 2	WB 1	WB 2	SB 1	
Volume Total	372	141	110	197	875	
Volume Left	372	0	0	0	302	
Volume Right	0	0	0	197	573	
cSH	1480	1700	1700	1700	418	
Volume to Capacity	0.25	0.08	0.06	0.12	2.09	
Queue Length 95th (m)	8.0	0.0	0.0	0.0	499.2	
Control Delay (s)	8.2	0.0	0.0	0.0	521.8	
Lane LOS	A				F	
Approach Delay (s)	6.0		0.0		521.8	
Approach LOS					F	
Intersection Summary						
Average Delay			271.2			
Intersection Capacity Utilization			80.1%		ICU Level of Service	D
Analysis Period (min)			15			

























Movement	EBL	EBR	NBL	NBT	SBT	SBR
Lane Configurations						
Traffic Volume (veh/h)	33	104	59	112	217	39
Future Volume (Veh/h)	33	104	59	112	217	39
Sign Control	Stop			Free	Free	
Grade	0%			0%	0%	
Peak Hour Factor	0.92	0.92	0.92	0.92	0.92	0.92
Hourly flow rate (vph)	36	113	64	122	236	42
Pedestrians						
Lane Width (m)						
Walking Speed (m/s)						
Percent Blockage						
Right turn flare (veh)						
Median type				None	None	
Median storage (veh)						
Upstream signal (m)						
pX, platoon unblocked						
vC, conflicting volume	507	257	278			
vC1, stage 1 conf vol						
vC2, stage 2 conf vol						
vCu, unblocked vol	507	257	278			
tC, single (s)	6.4	6.2	4.1			
tC, 2 stage (s)						
tF (s)	3.5	3.3	2.2			
p0 queue free %	93	86	95			
cM capacity (veh/h)	499	782	1285			
Direction, Lane #	EB 1	NB 1	NB 2	SB 1		
Volume Total	149	64	122	278		
Volume Left	36	64	0	0		
Volume Right	113	0	0	42		
cSH	688	1285	1700	1700		
Volume to Capacity	0.22	0.05	0.07	0.16		
Queue Length 95th (m)	6.6	1.3	0.0	0.0		
Control Delay (s)	11.7	7.9	0.0	0.0		
Lane LOS	B	A				
Approach Delay (s)	11.7	2.7	0.0			
Approach LOS	B					
Intersection Summary						
Average Delay	3.7					
Intersection Capacity Utilization	35.4%			ICU Level of Service	A	
Analysis Period (min)	15					

						
Movement	WBL	WBR	NBT	NBR	SBL	SBT
Lane Configurations						
Traffic Volume (veh/h)	75	21	144	12	7	322
Future Volume (Veh/h)	75	21	144	12	7	322
Sign Control	Stop		Free		Free	
Grade	0%		0%		0%	
Peak Hour Factor	0.92	0.92	0.92	0.92	0.92	0.92
Hourly flow rate (vph)	82	23	157	13	8	350
Pedestrians						
Lane Width (m)						
Walking Speed (m/s)						
Percent Blockage						
Right turn flare (veh)						
Median type	None			None		
Median storage veh						
Upstream signal (m)						
pX, platoon unblocked						
vC, conflicting volume	523	157			157	
vC1, stage 1 conf vol						
vC2, stage 2 conf vol						
vCu, unblocked vol	523	157			157	
tC, single (s)	6.4	6.2			4.1	
tC, 2 stage (s)						
tF (s)	3.5	3.3			2.2	
p0 queue free %	84	97			99	
cM capacity (veh/h)	511	889			1423	
Direction, Lane #	WB 1	NB 1	NB 2	SB 1	SB 2	
Volume Total	105	157	13	8	350	
Volume Left	82	0	0	8	0	
Volume Right	23	0	13	0	0	
cSH	564	1700	1700	1423	1700	
Volume to Capacity	0.19	0.09	0.01	0.01	0.21	
Queue Length 95th (m)	5.4	0.0	0.0	0.1	0.0	
Control Delay (s)	12.8	0.0	0.0	7.5	0.0	
Lane LOS	B			A		
Approach Delay (s)	12.8	0.0		0.2		
Approach LOS	B					
Intersection Summary						
Average Delay			2.2			
Intersection Capacity Utilization			29.1%	ICU Level of Service	A	
Analysis Period (min)	15					

Cooper Blvd Corridor Study
3: Cooper Blvd & Raynham Ave

2030 Projected w Improvements Conditions

Timing Plan: AM Peak

												
Movement	EBL	EBT	EBR	WBL	WBT	WBR	NBL	NBT	NBR	SBL	SBT	SBR
Lane Configurations												
Traffic Volume (veh/h)	6	15	262	116	29	11	95	130	43	11	436	20
Future Volume (Veh/h)	6	15	262	116	29	11	95	130	43	11	436	20
Sign Control		Stop			Stop			Free			Free	
Grade		0%			0%			0%			0%	
Peak Hour Factor	0.92	0.92	0.92	0.92	0.92	0.92	0.92	0.92	0.92	0.92	0.92	0.92
Hourly flow rate (vph)	7	16	285	126	32	12	103	141	47	12	474	22
Pedestrians												
Lane Width (m)												
Walking Speed (m/s)												
Percent Blockage												
Right turn flare (veh)												
Median type												
Median storage veh												
Upstream signal (m)												
pX, platoon unblocked												
vC, conflicting volume	872	856	485	996	867	141	496				141	
vC1, stage 1 conf vol												
vC2, stage 2 conf vol												
vCu, unblocked vol	872	856	485	996	867	141	496				141	
tC, single (s)	7.1	6.5	6.2	7.1	6.5	6.2	4.1				4.1	
tC, 2 stage (s)												
tF (s)	3.5	4.0	3.3	3.5	4.0	3.3	2.2				2.2	
p0 queue free %	97	94	51	0	88	99	90				99	
cM capacity (veh/h)	223	264	582	100	261	907	1068				1442	
Direction, Lane #	EB 1	WB 1	WB 2	NB 1	NB 2	NB 3	SB 1	SB 2				
Volume Total	308	126	44	103	141	47	12	496				
Volume Left	7	126	0	103	0	0	12	0				
Volume Right	285	0	12	0	0	47	0	22				
cSH	629	100	323	1068	1700	1700	1442	1700				
Volume to Capacity	0.49	1.26	0.14	0.10	0.08	0.03	0.01	0.29				
Queue Length 95th (m)	21.6	69.4	3.7	2.6	0.0	0.0	0.2	0.0				
Control Delay (s)	17.3	252.8	17.9	8.7	0.0	0.0	7.5	0.0				
Lane LOS	C	F	C	A			A					
Approach Delay (s)	17.3	192.0		3.1			0.2					
Approach LOS	C	F										
Intersection Summary												
Average Delay			30.5									
Intersection Capacity Utilization			56.8%		ICU Level of Service				B			
Analysis Period (min)			15									

Cooper Blvd Corridor Study
4: Cooper Blvd & Memorial Dr

2030 Projected w Improvements Conditions

Timing Plan: AM Peak



Lane Group	EBL	EBT	EBR	WBL	WBT	WBR	NBL	NBT	NBR	SBL	SBT	SBR
Lane Configurations		↖	↗	↖	↗		↖	↕		↖	↗	
Traffic Volume (vph)	13	30	181	66	11	10	99	289	82	38	888	22
Future Volume (vph)	13	30	181	66	11	10	99	289	82	38	888	22
Satd. Flow (prot)	0	1835	1583	1770	1729	0	1770	3422	0	1770	1855	0
Flt Permitted		0.902		0.501			0.111			0.498		
Satd. Flow (perm)	0	1680	1583	933	1729	0	207	3422	0	928	1855	0
Satd. Flow (RTOR)			197		11			80			3	
Lane Group Flow (vph)	0	47	197	72	23	0	108	403	0	41	989	0
Turn Type	Perm	NA	Perm	pm+pt	NA		pm+pt	NA		pm+pt	NA	
Protected Phases		4		3	8		5	2		1	6	
Permitted Phases	4		4	8			2			6		
Total Split (s)	12.0	12.0	12.0	6.0	18.0		6.0	92.0		10.0	96.0	
Total Lost Time (s)		4.5	4.5	3.5	4.5		3.5	4.5		3.5	4.5	
Act Effct Green (s)		7.8	7.8	13.4	12.4		46.0	43.6		50.0	44.4	
Actuated g/C Ratio		0.11	0.11	0.19	0.18		0.65	0.62		0.71	0.63	
v/c Ratio		0.25	0.56	0.35	0.07		0.56	0.19		0.06	0.85	
Control Delay		39.3	13.5	34.8	23.0		16.6	5.4		3.1	19.1	
Queue Delay		0.0	0.0	0.0	0.0		0.0	0.0		0.0	0.0	
Total Delay		39.3	13.5	34.8	23.0		16.6	5.4		3.1	19.1	
LOS		D	B	C	C		B	A		A	B	
Approach Delay		18.4			31.9			7.7			18.4	
Approach LOS		B			C			A			B	
Queue Length 50th (m)		6.2	0.0	8.5	1.4		3.9	11.0		1.5	105.2	
Queue Length 95th (m)		20.1	21.0	25.6	9.4		#8.7	16.6		3.5	160.7	
Internal Link Dist (m)		67.0			92.0			510.5			97.7	
Turn Bay Length (m)			20.0	35.0			107.0			92.0		
Base Capacity (vph)		192	355	208	358		192	3369		736	1841	
Starvation Cap Reductn		0	0	0	0		0	0		0	0	
Spillback Cap Reductn		0	0	0	0		0	0		0	0	
Storage Cap Reductn		0	0	0	0		0	0		0	0	
Reduced v/c Ratio		0.24	0.55	0.35	0.06		0.56	0.12		0.06	0.54	

Intersection Summary

Cycle Length: 120

Actuated Cycle Length: 70.8

Control Type: Actuated-Uncoordinated

Maximum v/c Ratio: 0.85

Intersection Signal Delay: 16.2

Intersection LOS: B

Intersection Capacity Utilization 77.2%

ICU Level of Service D

Analysis Period (min) 15

95th percentile volume exceeds capacity, queue may be longer.

Queue shown is maximum after two cycles.

Splits and Phases: 4: Cooper Blvd & Memorial Dr

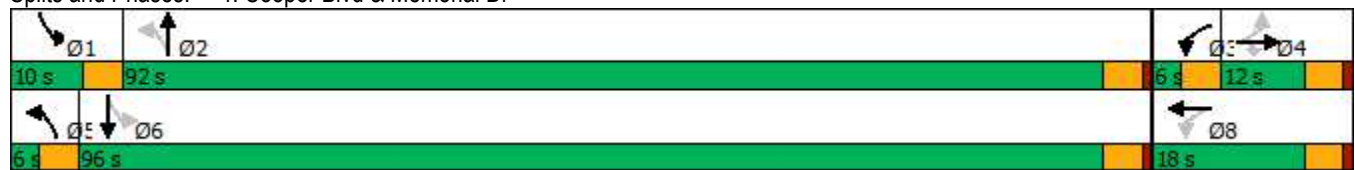

Cooper Blvd Corridor Study
5: Cooper Blvd & Roe Ave

2030 Projected w Improvements Conditions

Timing Plan: AM Peak

Lane Group	EBL	EBT	EBR	WBL	WBT	WBR	NBL	NBT	NBR	SBL	SBT	SBR
Lane Configurations												
Traffic Volume (vph)	32	160	73	90	87	72	68	264	109	203	710	74
Future Volume (vph)	32	160	73	90	87	72	68	264	109	203	710	74
Satd. Flow (prot)	1770	1863	1583	1770	1863	1583	1770	3383	0	1770	3490	0
Flt Permitted	0.695			0.462			0.273			0.446		
Satd. Flow (perm)	1295	1863	1583	861	1863	1583	509	3383	0	831	3490	0
Satd. Flow (RTOR)			121				121	78			14	
Lane Group Flow (vph)	35	174	79	98	95	78	74	405	0	221	852	0
Turn Type	pm+pt	NA	Perm	pm+pt	NA	Perm	pm+pt	NA		pm+pt	NA	
Protected Phases	7	4		3	8		5	2		1	6	
Permitted Phases	4		4	8		8	2			6		
Total Split (s)	13.0	24.0	24.0	13.0	24.0	24.0	13.0	38.0		15.0	40.0	
Total Lost Time (s)	4.0	5.0	5.0	4.0	5.0	5.0	4.0	5.0		4.0	5.0	
Act Effct Green (s)	20.0	12.9	12.9	21.8	15.8	15.8	43.0	33.7		47.2	38.3	
Actuated g/C Ratio	0.25	0.16	0.16	0.27	0.20	0.20	0.54	0.42		0.59	0.48	
v/c Ratio	0.09	0.58	0.22	0.30	0.26	0.19	0.18	0.28		0.37	0.51	
Control Delay	19.9	40.5	3.7	22.6	30.9	3.2	9.9	14.4		10.7	18.5	
Queue Delay	0.0	0.0	0.0	0.0	0.0	0.0	0.0	0.0		0.0	0.0	
Total Delay	19.9	40.5	3.7	22.6	30.9	3.2	9.9	14.4		10.7	18.5	
LOS	B	D	A	C	C	A	A	B		B	B	
Approach Delay		27.9			19.9			13.7			16.9	
Approach LOS		C			B			B			B	
Queue Length 50th (m)	4.0	27.4	0.0	11.6	14.1	0.0	4.9	18.7		16.2	54.1	
Queue Length 95th (m)	10.4	47.8	5.0	22.8	28.0	4.7	12.4	33.0		32.0	82.9	
Internal Link Dist (m)		98.9			80.2			211.7			510.5	
Turn Bay Length (m)	48.0		10.0	40.0		62.0	97.0			54.0		
Base Capacity (vph)	388	447	472	337	465	486	421	1465		624	1673	
Starvation Cap Reductn	0	0	0	0	0	0	0	0		0	0	
Spillback Cap Reductn	0	0	0	0	0	0	0	0		0	0	
Storage Cap Reductn	0	0	0	0	0	0	0	0		0	0	
Reduced v/c Ratio	0.09	0.39	0.17	0.29	0.20	0.16	0.18	0.28		0.35	0.51	

Intersection Summary

Cycle Length: 90

Actuated Cycle Length: 80.3

Control Type: Actuated-Uncoordinated

Maximum v/c Ratio: 0.58

Intersection Signal Delay: 18.1

Intersection LOS: B

Intersection Capacity Utilization 58.7%

ICU Level of Service B

Analysis Period (min) 15

Splits and Phases: 5: Cooper Blvd & Roe Ave

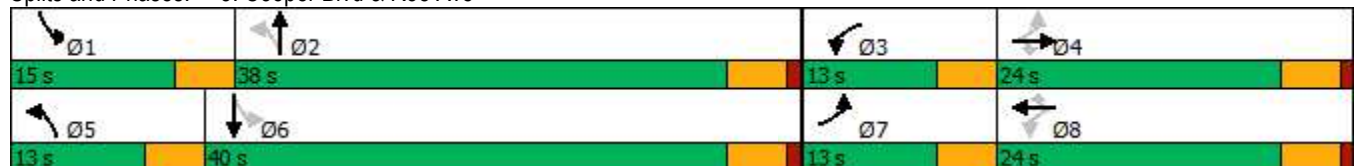



Lane Group	WBL	WBR	NBT	NBR	SBL	SBT
Lane Configurations	↙	↙	↕	↘	↘	↙
Traffic Volume (vph)	96	160	332	282	271	655
Future Volume (vph)	96	160	332	282	271	655
Satd. Flow (prot)	1770	1583	3295	0	0	3490
Flt Permitted	0.950					0.634
Satd. Flow (perm)	1770	1583	3295	0	0	2244
Satd. Flow (RTOR)		174	307			
Lane Group Flow (vph)	104	174	668	0	0	1007
Turn Type	Prot	Perm	NA		pm+pt	NA
Protected Phases	8		2		1	6
Permitted Phases		8			6	
Total Split (s)	24.0	24.0	53.5		12.5	66.0
Total Lost Time (s)	4.5	4.5	4.5			4.5
Act Effct Green (s)	10.5	10.5	64.6			64.6
Actuated g/C Ratio	0.12	0.12	0.77			0.77
v/c Ratio	0.47	0.50	0.26			0.58
Control Delay	40.2	10.6	1.8			6.2
Queue Delay	0.0	0.0	0.0			0.0
Total Delay	40.2	10.6	1.8			6.2
LOS	D	B	A			A
Approach Delay	21.7		1.8			6.2
Approach LOS	C		A			A
Queue Length 50th (m)	15.8	0.0	6.2			27.8
Queue Length 95th (m)	30.9	17.0	13.1			53.0
Internal Link Dist (m)	176.6		438.1			211.7
Turn Bay Length (m)		27.0				
Base Capacity (vph)	411	501	2601			1722
Starvation Cap Reductn	0	0	0			0
Spillback Cap Reductn	0	0	0			0
Storage Cap Reductn	0	0	0			0
Reduced v/c Ratio	0.25	0.35	0.26			0.58

Intersection Summary

Cycle Length: 90

Actuated Cycle Length: 84.1

Control Type: Actuated-Uncoordinated

Maximum v/c Ratio: 0.58

Intersection Signal Delay: 6.9

Intersection LOS: A

Intersection Capacity Utilization 62.1%

ICU Level of Service B

Analysis Period (min) 15

Splits and Phases: 6: Cooper Blvd & Catalina Rd

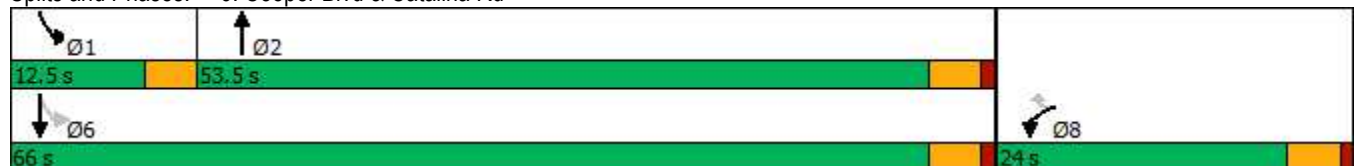

Cooper Blvd Corridor Study
7: Cooper Blvd & Airport Blvd

2030 Projected w Improvements Conditions

Timing Plan: AM Peak

Lane Group	EBL	EBT	EBR	WBL	WBT	WBR	NBL	NBT	NBR	SBL	SBT	SBR
Lane Configurations												
Traffic Volume (vph)	239	165	43	47	126	64	64	319	26	108	309	302
Future Volume (vph)	239	165	43	47	126	64	64	319	26	108	309	302
Satd. Flow (prot)	1770	1805	0	1770	1863	1583	1770	1842	0	1770	1863	1583
Flt Permitted	0.432			0.617			0.473			0.403		
Satd. Flow (perm)	805	1805	0	1149	1863	1583	881	1842	0	751	1863	1583
Satd. Flow (RTOR)		14				242		5				328
Lane Group Flow (vph)	260	226	0	51	137	70	70	375	0	117	336	328
Turn Type	pm+pt	NA		pm+pt	NA	Free	pm+pt	NA		pm+pt	NA	Perm
Protected Phases	7	4		3	8		5	2		1	6	
Permitted Phases	4			8		Free	2			6		6
Total Split (s)	18.0	28.0		13.0	23.0		13.0	36.0		13.0	36.0	36.0
Total Lost Time (s)	4.0	5.0		4.0	5.0		4.0	5.0		5.0	5.0	5.0
Act Effct Green (s)	26.2	18.4		18.5	11.7	77.6	39.6	32.5		38.9	33.0	33.0
Actuated g/C Ratio	0.34	0.24		0.24	0.15	1.00	0.51	0.42		0.50	0.43	0.43
v/c Ratio	0.60	0.51		0.15	0.49	0.04	0.13	0.49		0.24	0.42	0.38
Control Delay	25.7	30.5		18.6	39.3	0.0	10.9	22.8		12.4	21.6	3.9
Queue Delay	0.0	0.0		0.0	0.0	0.0	0.0	0.0		0.0	0.0	0.0
Total Delay	25.7	30.5		18.6	39.3	0.0	10.9	22.8		12.4	21.6	3.9
LOS	C	C		B	D	A	B	C		B	C	A
Approach Delay		27.9			24.6			20.9			12.8	
Approach LOS		C			C			C			B	
Queue Length 50th (m)	31.9	32.1		5.5	21.7	0.0	5.3	47.9		9.3	41.4	0.0
Queue Length 95th (m)	51.6	55.4		12.6	39.2	0.0	12.8	81.8		20.0	72.9	17.3
Internal Link Dist (m)		87.0			101.4			253.9			438.1	
Turn Bay Length (m)	55.0			50.0		100.0	78.0			82.0		
Base Capacity (vph)	467	589		362	452	1583	563	773		486	792	862
Starvation Cap Reductn	0	0		0	0	0	0	0		0	0	0
Spillback Cap Reductn	0	0		0	0	0	0	0		0	0	0
Storage Cap Reductn	0	0		0	0	0	0	0		0	0	0
Reduced v/c Ratio	0.56	0.38		0.14	0.30	0.04	0.12	0.49		0.24	0.42	0.38

Intersection Summary

Cycle Length: 90

Actuated Cycle Length: 77.6

Control Type: Actuated-Uncoordinated

Maximum v/c Ratio: 0.60

Intersection Signal Delay: 19.9

Intersection LOS: B

Intersection Capacity Utilization 60.8%

ICU Level of Service B

Analysis Period (min) 15

Splits and Phases: 7: Cooper Blvd & Airport Blvd

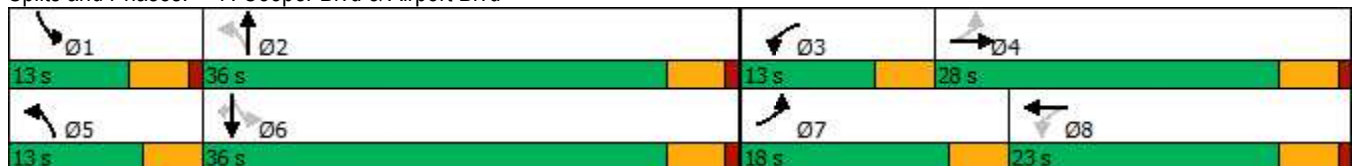













Movement	EBL	EBR	NBL	NBT	SBT	SBR
Lane Configurations						
Traffic Volume (veh/h)	67	23	32	317	280	136
Future Volume (Veh/h)	67	23	32	317	280	136
Sign Control	Stop			Free	Free	
Grade	0%			0%	0%	
Peak Hour Factor	0.92	0.92	0.92	0.92	0.92	0.92
Hourly flow rate (vph)	73	25	35	345	304	148
Pedestrians						
Lane Width (m)						
Walking Speed (m/s)						
Percent Blockage						
Right turn flare (veh)						
Median type				None	None	
Median storage veh						
Upstream signal (m)					278	
pX, platoon unblocked	0.96	0.96	0.96			
vC, conflicting volume	719	304	304			
vC1, stage 1 conf vol						
vC2, stage 2 conf vol						
vCu, unblocked vol	690	260	260			
tC, single (s)	6.4	6.2	4.1			
tC, 2 stage (s)						
tF (s)	3.5	3.3	2.2			
p0 queue free %	81	97	97			
cM capacity (veh/h)	385	751	1258			
Direction, Lane #	EB 1	NB 1	NB 2	SB 1	SB 2	
Volume Total	98	35	345	304	148	
Volume Left	73	35	0	0	0	
Volume Right	25	0	0	0	148	
cSH	440	1258	1700	1700	1700	
Volume to Capacity	0.22	0.03	0.20	0.18	0.09	
Queue Length 95th (m)	6.7	0.7	0.0	0.0	0.0	
Control Delay (s)	15.5	7.9	0.0	0.0	0.0	
Lane LOS	C	A				
Approach Delay (s)	15.5	0.7		0.0		
Approach LOS	C					
Intersection Summary						
Average Delay			1.9			
Intersection Capacity Utilization			33.2%	ICU Level of Service		A
Analysis Period (min)			15			



Movement	EBL	EBT	WBT	WBR	SBL	SBR
Lane Configurations						
Traffic Volume (veh/h)	319	65	93	173	86	195
Future Volume (Veh/h)	319	65	93	173	86	195
Sign Control		Free	Free		Stop	
Grade		0%	0%		0%	
Peak Hour Factor	0.92	0.92	0.92	0.92	0.92	0.92
Hourly flow rate (vph)	347	71	101	188	93	212
Pedestrians						
Lane Width (m)						
Walking Speed (m/s)						
Percent Blockage						
Right turn flare (veh)						19
Median type	None		None			
Median storage veh						
Upstream signal (m)						
pX, platoon unblocked						
vC, conflicting volume	101				866	101
vC1, stage 1 conf vol						
vC2, stage 2 conf vol						
vCu, unblocked vol	101				866	101
tC, single (s)	4.1				6.4	6.2
tC, 2 stage (s)						
tF (s)	2.2				3.5	3.3
p0 queue free %	77				63	78
cM capacity (veh/h)	1491				248	954
Direction, Lane #	EB 1	EB 2	WB 1	WB 2	SB 1	
Volume Total	347	71	101	188	305	
Volume Left	347	0	0	0	93	
Volume Right	0	0	0	188	212	
cSH	1491	1700	1700	1700	815	
Volume to Capacity	0.23	0.04	0.06	0.11	0.37	
Queue Length 95th (m)	7.2	0.0	0.0	0.0	14.0	
Control Delay (s)	8.1	0.0	0.0	0.0	15.4	
Lane LOS	A				C	
Approach Delay (s)	6.8		0.0		15.4	
Approach LOS					C	
Intersection Summary						
Average Delay			7.4			
Intersection Capacity Utilization			35.8%		ICU Level of Service	A
Analysis Period (min)			15			

























Movement	EBL	EBR	NBL	NBT	SBT	SBR
Lane Configurations						
Traffic Volume (veh/h)	38	117	157	256	146	9
Future Volume (Veh/h)	38	117	157	256	146	9
Sign Control	Stop			Free	Free	
Grade	0%			0%	0%	
Peak Hour Factor	0.92	0.92	0.92	0.92	0.92	0.92
Hourly flow rate (vph)	41	127	171	278	159	10
Pedestrians						
Lane Width (m)						
Walking Speed (m/s)						
Percent Blockage						
Right turn flare (veh)						
Median type				None	None	
Median storage veh						
Upstream signal (m)						
pX, platoon unblocked						
vC, conflicting volume	784	164	169			
vC1, stage 1 conf vol						
vC2, stage 2 conf vol						
vCu, unblocked vol	784	164	169			
tC, single (s)	6.4	6.2	4.1			
tC, 2 stage (s)						
tF (s)	3.5	3.3	2.2			
p0 queue free %	87	86	88			
cM capacity (veh/h)	318	881	1409			
Direction, Lane #	EB 1	NB 1	NB 2	SB 1		
Volume Total	168	171	278	169		
Volume Left	41	171	0	0		
Volume Right	127	0	0	10		
cSH	615	1409	1700	1700		
Volume to Capacity	0.27	0.12	0.16	0.10		
Queue Length 95th (m)	8.8	3.3	0.0	0.0		
Control Delay (s)	13.0	7.9	0.0	0.0		
Lane LOS	B	A				
Approach Delay (s)	13.0	3.0	0.0			
Approach LOS	B					
Intersection Summary						
Average Delay	4.5					
Intersection Capacity Utilization	36.2%			ICU Level of Service	A	
Analysis Period (min)	15					

						
Movement	WBL	WBR	NBT	NBR	SBL	SBT
Lane Configurations						
Traffic Volume (veh/h)	27	12	390	44	15	236
Future Volume (Veh/h)	27	12	390	44	15	236
Sign Control	Stop		Free			Free
Grade	0%		0%			0%
Peak Hour Factor	0.92	0.92	0.92	0.92	0.92	0.92
Hourly flow rate (vph)	29	13	424	48	16	257
Pedestrians						
Lane Width (m)						
Walking Speed (m/s)						
Percent Blockage						
Right turn flare (veh)						
Median type			None			None
Median storage veh						
Upstream signal (m)						
pX, platoon unblocked						
vC, conflicting volume	713	424			424	
vC1, stage 1 conf vol						
vC2, stage 2 conf vol						
vCu, unblocked vol	713	424			424	
tC, single (s)	6.4	6.2			4.1	
tC, 2 stage (s)						
tF (s)	3.5	3.3			2.2	
p0 queue free %	93	98			99	
cM capacity (veh/h)	393	630			1135	
Direction, Lane #	WB 1	NB 1	NB 2	SB 1	SB 2	
Volume Total	42	424	48	16	257	
Volume Left	29	0	0	16	0	
Volume Right	13	0	48	0	0	
cSH	445	1700	1700	1135	1700	
Volume to Capacity	0.09	0.25	0.03	0.01	0.15	
Queue Length 95th (m)	2.5	0.0	0.0	0.3	0.0	
Control Delay (s)	13.9	0.0	0.0	8.2	0.0	
Lane LOS	B			A		
Approach Delay (s)	13.9	0.0		0.5		
Approach LOS	B					
Intersection Summary						
Average Delay			0.9			
Intersection Capacity Utilization			30.5%		ICU Level of Service	A
Analysis Period (min)			15			

Cooper Blvd Corridor Study
3: Cooper Blvd & Raynham Ave

2030 Projected Conditions w Improvements

Timing Plan: PM Peak

												
Movement	EBL	EBT	EBR	WBL	WBT	WBR	NBL	NBT	NBR	SBL	SBT	SBR
Lane Configurations												
Traffic Volume (veh/h)	12	45	130	75	27	13	308	431	128	8	255	33
Future Volume (Veh/h)	12	45	130	75	27	13	308	431	128	8	255	33
Sign Control		Stop			Stop			Free			Free	
Grade		0%			0%			0%			0%	
Peak Hour Factor	0.92	0.92	0.92	0.92	0.92	0.92	0.92	0.92	0.92	0.92	0.92	0.92
Hourly flow rate (vph)	13	49	141	82	29	14	335	468	139	9	277	36
Pedestrians												
Lane Width (m)												
Walking Speed (m/s)												
Percent Blockage												
Right turn flare (veh)												
Median type												
Median storage veh												
Upstream signal (m)												
pX, platoon unblocked												
vC, conflicting volume	1466	1451	295	1528	1469	468	313			468		
vC1, stage 1 conf vol												
vC2, stage 2 conf vol												
vCu, unblocked vol	1466	1451	295	1528	1469	468	313			468		
tC, single (s)	7.1	6.5	6.2	7.1	6.5	6.2	4.1			4.1		
tC, 2 stage (s)												
tF (s)	3.5	4.0	3.3	3.5	4.0	3.3	2.2			2.2		
p0 queue free %	79	48	81	0	69	98	73			99		
cM capacity (veh/h)	63	95	744	37	92	595	1247			1094		
Direction, Lane #	EB 1	WB 1	WB 2	NB 1	NB 2	NB 3	SB 1	SB 2				
Volume Total	203	82	43	335	468	139	9	313				
Volume Left	13	82	0	335	0	0	9	0				
Volume Right	141	0	14	0	0	139	0	36				
cSH	288	37	128	1247	1700	1700	1094	1700				
Volume to Capacity	0.70	2.20	0.34	0.27	0.28	0.08	0.01	0.18				
Queue Length 95th (m)	39.1	72.1	10.8	8.7	0.0	0.0	0.2	0.0				
Control Delay (s)	41.6	783.9	47.0	8.9	0.0	0.0	8.3	0.0				
Lane LOS	E	F	E	A			A					
Approach Delay (s)	41.6	530.4		3.2			0.2					
Approach LOS	E	F										
Intersection Summary												
Average Delay			48.9									
Intersection Capacity Utilization			53.3%		ICU Level of Service				A			
Analysis Period (min)			15									

Lane Group	EBL	EBT	EBR	WBL	WBT	WBR	NBL	NBT	NBR	SBL	SBT	SBR
Lane Configurations												
Traffic Volume (vph)	21	15	155	70	24	27	235	941	84	18	519	11
Future Volume (vph)	21	15	155	70	24	27	235	941	84	18	519	11
Satd. Flow (prot)	0	1809	1583	1770	1716	0	1770	3497	0	1770	1857	0
Flt Permitted		0.787		0.470			0.221			0.256		
Satd. Flow (perm)	0	1466	1583	875	1716	0	412	3497	0	477	1857	0
Satd. Flow (RTOR)			168		29			15			2	
Lane Group Flow (vph)	0	39	168	76	55	0	255	1114	0	20	576	0
Turn Type	Perm	NA	Perm	pm+pt	NA		pm+pt	NA		pm+pt	NA	
Protected Phases		4		3	8		5	2		1	6	
Permitted Phases	4		4	8			2			6		
Total Split (s)	19.4	19.4	19.4	9.6	29.0		13.0	50.0		11.0	48.0	
Total Lost Time (s)		4.5	4.5	3.5	4.5		3.5	4.5		3.5	4.5	
Act Effct Green (s)		9.6	9.6	16.4	16.5		40.2	39.5		34.8	25.2	
Actuated g/C Ratio		0.16	0.16	0.27	0.27		0.66	0.65		0.57	0.41	
v/c Ratio		0.17	0.43	0.22	0.11		0.51	0.49		0.04	0.75	
Control Delay		30.5	9.7	21.6	13.3		9.7	10.0		5.6	23.5	
Queue Delay		0.0	0.0	0.0	0.0		0.0	0.0		0.0	0.0	
Total Delay		30.5	9.7	21.6	13.3		9.7	10.0		5.6	23.5	
LOS		C	A	C	B		A	A		A	C	
Approach Delay		13.6			18.1			9.9			22.9	
Approach LOS		B			B			A			C	
Queue Length 50th (m)		4.5	0.0	6.9	2.4		13.0	38.8		0.9	62.1	
Queue Length 95th (m)		14.8	17.0	20.2	12.0		25.4	86.9		3.3	104.3	
Internal Link Dist (m)		67.0			92.0			510.5			101.9	
Turn Bay Length (m)			20.0	35.0			107.0			92.0		
Base Capacity (vph)		406	560	338	798		512	2583		453	1326	
Starvation Cap Reductn		0	0	0	0		0	0		0	0	
Spillback Cap Reductn		0	0	0	0		0	0		0	0	
Storage Cap Reductn		0	0	0	0		0	0		0	0	
Reduced v/c Ratio		0.10	0.30	0.22	0.07		0.50	0.43		0.04	0.43	

Intersection Summary

Cycle Length: 90

Actuated Cycle Length: 60.8

Control Type: Actuated-Uncoordinated

Maximum v/c Ratio: 0.75

Intersection Signal Delay: 14.1

Intersection LOS: B

Intersection Capacity Utilization 62.4%

ICU Level of Service B

Analysis Period (min) 15

Splits and Phases: 4: Cooper Blvd & Memorial Dr

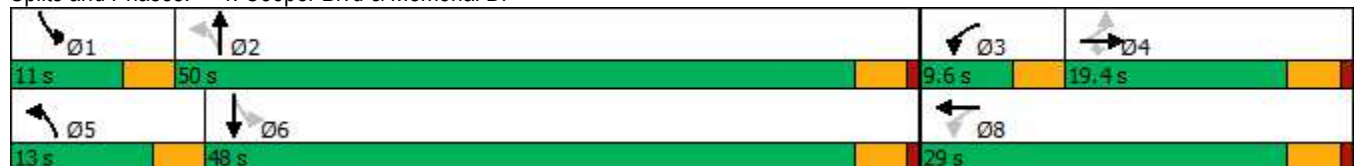

Cooper Blvd Corridor Study
5: Cooper Blvd & Roe Ave

2030 Projected Conditions w Improvements

Timing Plan: PM Peak

Lane Group	EBL	EBT	EBR	WBL	WBT	WBR	NBL	NBT	NBR	SBL	SBT	SBR
Lane Configurations												
Traffic Volume (vph)	110	156	57	299	220	270	79	750	70	109	427	25
Future Volume (vph)	110	156	57	299	220	270	79	750	70	109	427	25
Satd. Flow (prot)	1770	1863	1583	1770	1863	1583	1770	3493	0	1770	3511	0
Flt Permitted	0.610			0.426			0.416			0.172		
Satd. Flow (perm)	1136	1863	1583	794	1863	1583	775	3493	0	320	3511	0
Satd. Flow (RTOR)			170			293		11			7	
Lane Group Flow (vph)	120	170	62	325	239	293	86	891	0	118	491	0
Turn Type	pm+pt	NA	Perm	pm+pt	NA	Perm	pm+pt	NA		pm+pt	NA	
Protected Phases	7	4		3	8		5	2		1	6	
Permitted Phases	4		4	8		8	2			6		
Total Split (s)	13.0	23.0	23.0	20.0	30.0	30.0	13.0	34.0		13.0	34.0	
Total Lost Time (s)	4.0	5.0	5.0	4.0	5.0	5.0	4.0	5.0		4.0	5.0	
Act Effct Green (s)	22.5	12.7	12.7	32.1	21.5	21.5	36.9	29.6		37.2	29.7	
Actuated g/C Ratio	0.28	0.16	0.16	0.40	0.27	0.27	0.46	0.37		0.46	0.37	
v/c Ratio	0.31	0.58	0.16	0.66	0.48	0.46	0.19	0.69		0.39	0.38	
Control Delay	19.1	40.9	0.9	25.4	30.7	6.0	13.0	26.7		16.0	21.3	
Queue Delay	0.0	0.0	0.0	0.0	0.0	0.0	0.0	0.0		0.0	0.0	
Total Delay	19.1	40.9	0.9	25.4	30.7	6.0	13.0	26.7		16.0	21.3	
LOS	B	D	A	C	C	A	B	C		B	C	
Approach Delay		26.4			20.2			25.5			20.3	
Approach LOS		C			C			C			C	
Queue Length 50th (m)	12.7	27.2	0.0	39.3	35.6	0.0	7.2	68.1		10.1	32.1	
Queue Length 95th (m)	24.0	47.3	0.0	62.6	58.5	18.7	16.5	99.6		21.5	50.7	
Internal Link Dist (m)		98.9			80.2			211.7			510.5	
Turn Bay Length (m)	48.0		10.0	40.0		62.0	97.0			54.0		
Base Capacity (vph)	396	425	492	515	590	702	473	1291		315	1302	
Starvation Cap Reductn	0	0	0	0	0	0	0	0		0	0	
Spillback Cap Reductn	0	0	0	0	0	0	0	0		0	0	
Storage Cap Reductn	0	0	0	0	0	0	0	0		0	0	
Reduced v/c Ratio	0.30	0.40	0.13	0.63	0.41	0.42	0.18	0.69		0.37	0.38	

Intersection Summary

Cycle Length: 90

Actuated Cycle Length: 80.4

Control Type: Actuated-Uncoordinated

Maximum v/c Ratio: 0.69

Intersection Signal Delay: 22.9

Intersection LOS: C

Intersection Capacity Utilization 69.4%

ICU Level of Service C

Analysis Period (min) 15

Splits and Phases: 5: Cooper Blvd & Roe Ave

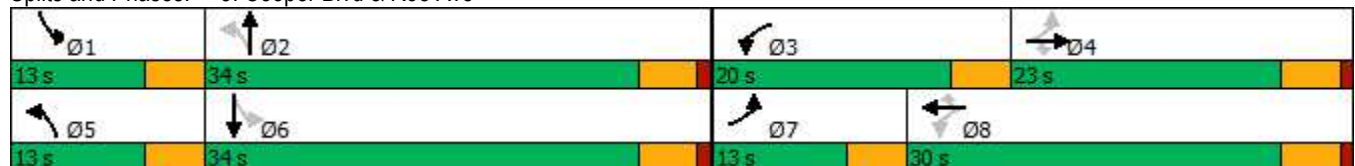



Lane Group	WBL	WBR	NBT	NBR	SBL	SBT
Lane Configurations	↙	↙	↕	↘	↙	↘
Traffic Volume (vph)	238	301	719	265	192	550
Future Volume (vph)	238	301	719	265	192	550
Satd. Flow (prot)	1770	1583	3398	0	0	3493
Flt Permitted	0.950					0.545
Satd. Flow (perm)	1770	1583	3398	0	0	1929
Satd. Flow (RTOR)		271	79			
Lane Group Flow (vph)	259	327	1070	0	0	807
Turn Type	Prot	Perm	NA		pm+pt	NA
Protected Phases	8		2		1	6
Permitted Phases		8			6	
Total Split (s)	31.0	31.0	56.5		12.5	69.0
Total Lost Time (s)	4.5	4.5	4.5			4.5
Act Effct Green (s)	18.6	18.6	64.7			64.7
Actuated g/C Ratio	0.20	0.20	0.70			0.70
v/c Ratio	0.73	0.61	0.44			0.60
Control Delay	46.7	12.2	6.8			10.3
Queue Delay	0.0	0.0	0.0			0.0
Total Delay	46.7	12.2	6.8			10.3
LOS	D	B	A			B
Approach Delay	27.5		6.8			10.3
Approach LOS	C		A			B
Queue Length 50th (m)	45.5	8.7	35.6			34.9
Queue Length 95th (m)	71.7	33.7	63.3			68.5
Internal Link Dist (m)	176.6		438.1			211.7
Turn Bay Length (m)		27.0				
Base Capacity (vph)	509	648	2405			1352
Starvation Cap Reductn	0	0	0			0
Spillback Cap Reductn	0	0	0			0
Storage Cap Reductn	0	0	0			0
Reduced v/c Ratio	0.51	0.50	0.44			0.60

Intersection Summary

Cycle Length: 100
 Actuated Cycle Length: 92.3
 Control Type: Actuated-Uncoordinated
 Maximum v/c Ratio: 0.73
 Intersection Signal Delay: 12.8
 Intersection LOS: B
 Intersection Capacity Utilization 73.6%
 ICU Level of Service D
 Analysis Period (min) 15

Splits and Phases: 6: Cooper Blvd & Catalina Rd

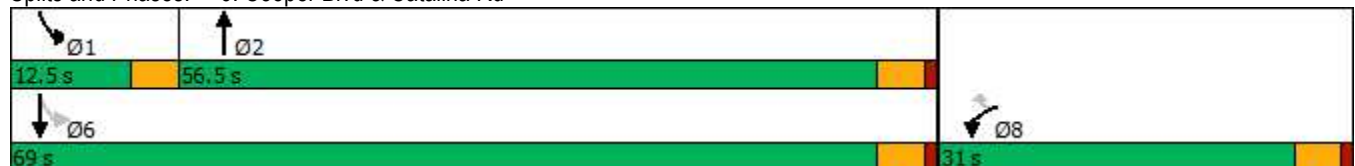

Cooper Blvd Corridor Study
7: Cooper Blvd & Airport Blvd

2030 Projected Conditions w Improvements

Timing Plan: PM Peak

Lane Group	EBL	EBT	EBR	WBL	WBT	WBR	NBL	NBT	NBR	SBL	SBT	SBR
Lane Configurations												
Traffic Volume (vph)	321	144	61	242	282	204	40	423	14	142	399	334
Future Volume (vph)	321	144	61	242	282	204	40	423	14	142	399	334
Satd. Flow (prot)	1770	1781	0	1770	1863	1583	1770	1853	0	1770	1863	1583
Flt Permitted	0.216			0.547			0.369			0.206		
Satd. Flow (perm)	402	1781	0	1019	1863	1583	687	1853	0	384	1863	1583
Satd. Flow (RTOR)		22				222		2				363
Lane Group Flow (vph)	349	223	0	263	307	222	43	475	0	154	434	363
Turn Type	pm+pt	NA		pm+pt	NA	Free	pm+pt	NA		pm+pt	NA	Perm
Protected Phases	7	4		3	8		5	2		1	6	
Permitted Phases	4			8		Free	2			6		6
Total Split (s)	19.0	26.0		17.0	24.0		13.0	34.0		13.0	34.0	34.0
Total Lost Time (s)	4.0	5.0		4.0	5.0		4.0	5.0		4.0	5.0	5.0
Act Effct Green (s)	35.9	20.3		30.6	17.5	88.1	38.0	29.0		41.0	34.7	34.7
Actuated g/C Ratio	0.41	0.23		0.35	0.20	1.00	0.43	0.33		0.47	0.39	0.39
v/c Ratio	0.88	0.52		0.58	0.83	0.14	0.11	0.78		0.49	0.59	0.43
Control Delay	45.6	32.0		23.2	54.3	0.2	13.4	37.5		18.9	27.4	4.3
Queue Delay	0.0	0.0		0.0	0.0	0.0	0.0	0.0		0.0	0.0	0.0
Total Delay	45.6	32.0		23.2	54.3	0.2	13.4	37.5		18.9	27.4	4.3
LOS	D	C		C	D	A	B	D		B	C	A
Approach Delay		40.3			28.8			35.5			17.2	
Approach LOS		D			C			D			B	
Queue Length 50th (m)	43.6	31.9		31.0	53.1	0.0	4.0	77.8		15.4	68.0	0.0
Queue Length 95th (m)	#93.0	54.7		49.9	#93.1	0.0	9.7	#127.3		27.2	102.8	18.8
Internal Link Dist (m)		87.0			101.4			253.9			438.1	
Turn Bay Length (m)	55.0			50.0		100.0	78.0			82.0		
Base Capacity (vph)	397	441		475	402	1583	415	611		320	733	843
Starvation Cap Reductn	0	0		0	0	0	0	0		0	0	0
Spillback Cap Reductn	0	0		0	0	0	0	0		0	0	0
Storage Cap Reductn	0	0		0	0	0	0	0		0	0	0
Reduced v/c Ratio	0.88	0.51		0.55	0.76	0.14	0.10	0.78		0.48	0.59	0.43

Intersection Summary

Cycle Length: 90

Actuated Cycle Length: 88.1

Control Type: Actuated-Uncoordinated

Maximum v/c Ratio: 0.88

Intersection Signal Delay: 28.4

Intersection LOS: C

Intersection Capacity Utilization 78.6%

ICU Level of Service D

Analysis Period (min) 15

95th percentile volume exceeds capacity, queue may be longer.

Queue shown is maximum after two cycles.

Splits and Phases: 7: Cooper Blvd & Airport Blvd





Movement	EBL	EBR	NBL	NBT	SBT	SBR
Lane Configurations						
Traffic Volume (veh/h)	232	72	42	322	671	184
Future Volume (Veh/h)	232	72	42	322	671	184
Sign Control	Stop			Free	Free	
Grade	0%			0%	0%	
Peak Hour Factor	0.92	0.92	0.92	0.92	0.92	0.92
Hourly flow rate (vph)	252	78	46	350	729	200
Pedestrians						
Lane Width (m)						
Walking Speed (m/s)						
Percent Blockage						
Right turn flare (veh)						
Median type				None	None	
Median storage veh						
Upstream signal (m)					278	
pX, platoon unblocked	0.77	0.77	0.77			
vC, conflicting volume	1171	729	729			
vC1, stage 1 conf vol						
vC2, stage 2 conf vol						
vCu, unblocked vol	1073	499	499			
tC, single (s)	6.4	6.2	4.1			
tC, 2 stage (s)						
tF (s)	3.5	3.3	2.2			
p0 queue free %	0	82	94			
cM capacity (veh/h)	177	440	820			
Direction, Lane #	EB 1	NB 1	NB 2	SB 1	SB 2	
Volume Total	330	46	350	729	200	
Volume Left	252	46	0	0	0	
Volume Right	78	0	0	0	200	
cSH	206	820	1700	1700	1700	
Volume to Capacity	1.60	0.06	0.21	0.43	0.12	
Queue Length 95th (m)	170.1	1.4	0.0	0.0	0.0	
Control Delay (s)	332.3	9.6	0.0	0.0	0.0	
Lane LOS	F	A				
Approach Delay (s)	332.3	1.1		0.0		
Approach LOS	F					
Intersection Summary						
Average Delay			66.5			
Intersection Capacity Utilization			59.2%	ICU Level of Service	B	
Analysis Period (min)			15			



Movement	EBL	EBT	WBT	WBR	SBL	SBR
Lane Configurations						
Traffic Volume (veh/h)	342	130	101	181	278	527
Future Volume (Veh/h)	342	130	101	181	278	527
Sign Control		Free	Free		Stop	
Grade		0%	0%		0%	
Peak Hour Factor	0.92	0.92	0.92	0.92	0.92	0.92
Hourly flow rate (vph)	372	141	110	197	302	573
Pedestrians						
Lane Width (m)						
Walking Speed (m/s)						
Percent Blockage						
Right turn flare (veh)						19
Median type	None		None			
Median storage veh						
Upstream signal (m)						
pX, platoon unblocked						
vC, conflicting volume	110				995	110
vC1, stage 1 conf vol						
vC2, stage 2 conf vol						
vCu, unblocked vol	110				995	110
tC, single (s)	4.1				6.4	6.2
tC, 2 stage (s)						
tF (s)	2.2				3.5	3.3
p0 queue free %	75				0	39
cM capacity (veh/h)	1480				203	943
Direction, Lane #	EB 1	EB 2	WB 1	WB 2	SB 1	
Volume Total	372	141	110	197	875	
Volume Left	372	0	0	0	302	
Volume Right	0	0	0	197	573	
cSH	1480	1700	1700	1700	548	
Volume to Capacity	0.25	0.08	0.06	0.12	1.60	
Queue Length 95th (m)	8.0	0.0	0.0	0.0	382.3	
Control Delay (s)	8.2	0.0	0.0	0.0	297.1	
Lane LOS	A				F	
Approach Delay (s)	6.0	0.0		297.1		
Approach LOS					F	
Intersection Summary						
Average Delay			155.2			
Intersection Capacity Utilization			47.7%		ICU Level of Service	
Analysis Period (min)			15			
			A			

APPENDIX C – TRAFFIC SIGNAL WARRANT ANALYSIS WORKSHEETS



Town of Gander - Traffic Signal & Pedestrian Signal Head Warrant Analysis

Main Street (name)	Cooper Blvd	Direction (EW or NS)	NS	Road Authority:	Town of Gander
Side Street (name)	Catalina Dr	Direction (EW or NS)	EW	City:	Town of Gander
Quadrant / Int #	6	Comments	Enter Comments about the analysis here.	Analysis Date:	2020 Feb 28, Fri
for Warrant Calculation Results, please hit 'Page Down'			CHECKSHEET	Count Date:	2019 Dec 03, Tue
				Date Entry Format:	(yyyy-mm-dd)

Lane Configuration		Excl LT	Th & LT	Through	Th+RT+LT	Th & RT	Excl RT	RT Channelization (y/n)	Upstream Signal (m)	# of Thru Lanes	LT Phase Type	RTOR Allowed (y/n)	Actuated Thru Phase
Cooper Blvd NB				1		1		n	425	1			
Cooper Blvd SB		1							220	1			
Catalina Dr WB		1					1	n	5,000	0			
Catalina Dr EB										0			

Saturation Flow Rates (if not default) (vphpl)	Default Saturation Flow Rates (vphpl)
Left Turn	1,650
Through	1,800
Right Turn	1,500

Are the Cooper Blvd NB right turns significantly impeded by through movements? (y/n)

n

Demographics		
Elem. School/Mobility Challenged	(y/n)	n
Senior's Complex	(y/n)	n
Pathway to School	(y/n)	n
Metro Area Population (#)		12,000
Central Business District	(y/n)	y

Other input	Speed (Km/h)	Truck %	Bus Rt (y/n)	Median (m)
Cooper Blvd	NS	60	y	0.0
Catalina Dr	EW		n	0.0

Traffic Input	NB			SB			WB			EB			Ped1 NS	Ped2 NS	Ped3 EW	Ped4 EW
	LT	Th	RT	LT	Th	RT	LT	Th	RT	LT	Th	RT	W Side	E Side	N Side	S Side
	0	197	49	152	279	68	114	0	137	0	0	0	0	0	0	0
0	332	282	271	655	0	96	0	160								
0	408	72	133	471	84	91										
0	293	59	84	362	50	75										
0	719	265	192	550	0	238	0	301								
0	274	51	66	223	34	83										
Total (6-hour peak)	0	2,222	777	898	2,541	0	570	0	823	0	0	0	0	0	0	0
Average (6-hour peak)	0	370	129	150	423	0	95	0	137	0	0	0	0	0	0	0

Actual Pedestrian Crossing Distance (m)

13.0 15.0 13.0

Average 6-hour Peak Turning Movements

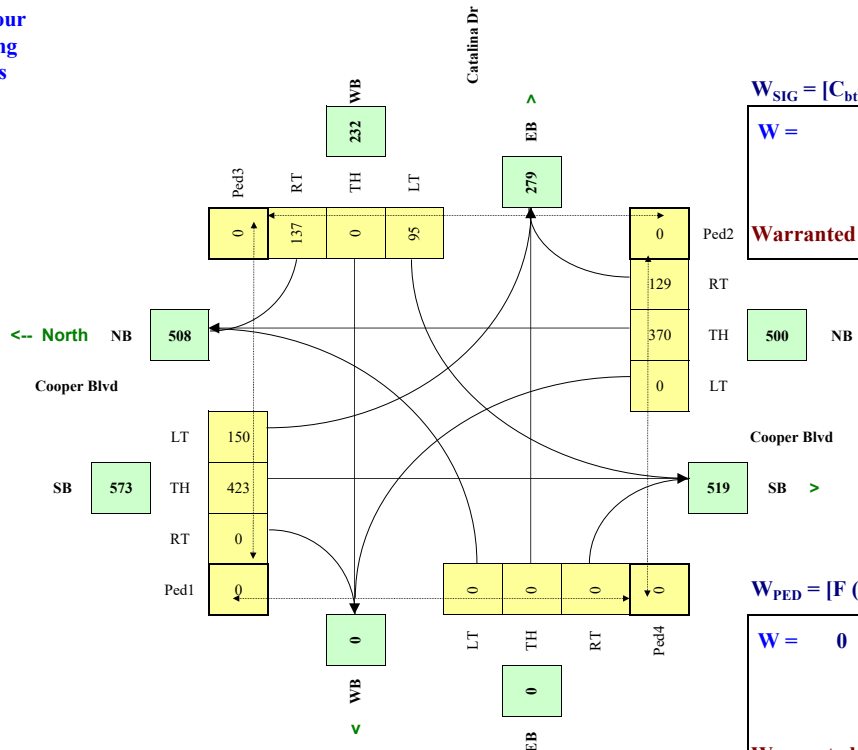

$$W_{SIG} = [C_{bt}(X_{v,v}) / K_1 + (F(X_{v,p}) L) / K_2] \times C_i$$

W =	124	124	0
		Veh	Ped

Warranted

RESET SHEET

$$W_{PED} = [F((X_{ped,m})d_m/K_2) + (X_{ped,s})d_s/K_3]$$

W =	0
-----	---

Warranted - Complex Intersection



Town of Gander - Traffic Signal & Pedestrian Signal Head Warrant Analysis

Main Street (name)	Cooper Blvd	Direction (EW or NS)	NS	Road Authority:	Town of Gander
Side Street (name)	Laurel Rd	Direction (EW or NS)	EW	City:	Town of Gander
Quadrant / Int #	8	Comments	Enter Comments about the analysis here.	Analysis Date:	2020 Feb 28, Fri
for Warrant Calculation Results, please hit 'Page Down'	CHECKSHEET			Count Date:	2019 Dec 02, Mon
				Date Entry Format:	(yyyy-mm-dd)

Lane Configuration		Excl LT	Th & LT	Through	Th+RT-LT	Th & RT	Excl RT	RT Channelization (y/n)	UpStream Signal (m)	# of Thru Lanes	LT Phase Type	RTOR Allowed (y/n)	Actuated Thru Phase
Cooper Blvd NB		1		1				y	5,000	1			
Cooper Blvd SB				1			1		170	1			
Laurel Rd WB								n	5,000	0			
Laurel Rd EB					1				5,000	1			

Saturation Flow Rates (if not default) (vphpl)	Default Saturation Flow Rates (vphpl)
Left Turn	1,650
Through	1,800
Right Turn	1,500

Are the Laurel Rd EB right turns significantly impeded by through movements? (y/n)

n

Demographics		
Elem. School/Mobility Challenged	(y/n)	n
Senior's Complex	(y/n)	n
Pathway to School	(y/n)	n
Metro Area Population (#)		12,000
Central Business District	(y/n)	y

Other input	Speed (Km/h)	Truck %	Bus Rt (y/n)	Median (m)
Cooper Blvd	NS	60	y	0.0
Laurel Rd	EW		n	0.0

Traffic Input	NB			SB			WB			EB			Ped1 NS	Ped2 NS	Ped3 EW	Ped4 EW
	LT	Th	RT	LT	Th	RT	LT	Th	RT	LT	Th	RT	W Side	E Side	N Side	S Side
	33.13866	193.3089	0	0	85.0559	62.96346					39.766397	0	15.46471			
32	317.0414	0	0	225.1922	136					67	0	23				
60.75422	204.3551	0	0	183.3673	198.832					161.27483	0	58.54497				
48.60337	148.0194	0	0	203.2505	172.3211					209.8782	0	55.23111				
42	322.6399	0	0	517	184					232	0	72				
30.92942	96.10212	0	0	178.9488	142.4963					125.92692	0	40.87102				
Total (6-hour peak)	247	1,281	0	0	1,393	897	0	0	0	836	0	265	0	0	0	0
Average (6-hour peak)	41	214	0	0	232	149	0	0	0	139	0	44	0	0	0	0

Actual Pedestrian Crossing Distance (m)

10.0 24.0 20.0

Average 6-hour Peak Turning Movements

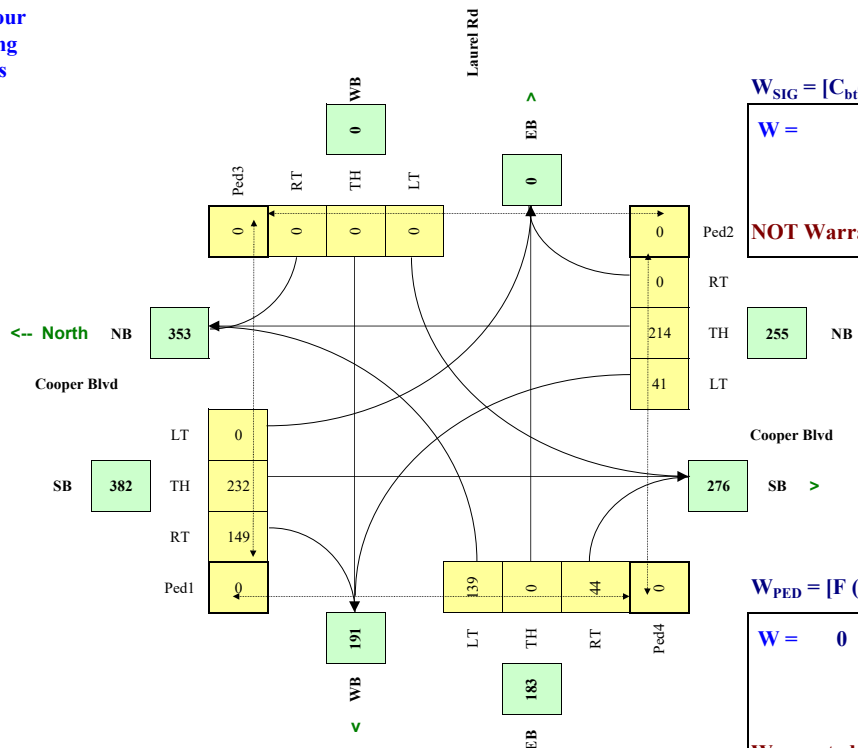

$$W_{SIG} = [C_{bt}(X_{v,v}) / K_1 + (F(X_{v,p}) L) / K_2] \times C_i$$

W = 54 54 0

Veh Ped

NOT Warranted

$$W_{PED} = [F((X_{ped,m})d_m/K_2) + (X_{ped,s})d_s/K_3]$$

W = 0

Warranted - Complex Intersection



Town of Gander - Traffic Signal & Pedestrian Signal Head Warrant Analysis

Main Street (name)	Cooper Blvd	Direction (EW or NS)	NS	Road Authority:	Town of Gander
Side Street (name)	Memorial Dr	Direction (EW or NS)	EW	City:	Town of Gander
Quadrant / Int #	4	Comments	Enter Comments about the analysis here.	Analysis Date:	2020 Feb 27, Thu
for Warrant Calculation Results, please hit 'Page Down'	CHECKSHEET			Count Date:	2018 Jun 14, Thu
				Date Entry Format:	(yyyy-mm-dd)

Lane Configuration		Excl LT	Th & LT	Through	Th+RT-LT	Th & RT	Excl RT	RT Channelization (y/n)	UpStream Signal (m)	# of Thru Lanes	LT Phase Type	RTOR Allowed (y/n)	Actuated Thru Phase
Cooper Blvd NB		1				1		y	535	1			
Cooper Blvd SB		1				1		n	5,000	1			
Memorial Dr WB					1			y	5,000	1			
Memorial Dr EB								y	1,200	1			

Saturation Flow Rates (if not default) (vphpl)	Default Saturation Flow Rates (vphpl)
Left Turn	1,650
Through	1,800
Right Turn	1,500

Are the Memorial Dr WB right turns significantly impeded by through movements? (y/n) n
 Are the Memorial Dr EB right turns significantly impeded by through movements? (y/n) n
 Are the Cooper Blvd NB right turns significantly impeded by through movements? (y/n) n
 Are the Cooper Blvd SB right turns significantly impeded by through movements? (y/n) n

Demographics		
Elem. School/Mobility Challenged	(y/n)	n
Senior's Complex	(y/n)	n
Pathway to School	(y/n)	n
Metro Area Population (#)	(#)	12,000
Central Business District	(y/n)	y

Other input	Speed (Km/h)	Truck %	Bus Rt (y/n)	Median (m)
Cooper Blvd NS	60		y	0.0
Memorial Dr EW			y	0.0

Traffic Input	NB			SB			WB			EB			Ped1 NS	Ped2 NS	Ped3 EW	Ped4 EW
	LT	Th	RT	LT	Th	RT	LT	Th	RT	LT	Th	RT	W Side	E Side	N Side	S Side
	39,7664	77,32355	44,18489	17,67395	237,4938	8,836977	17,67395	12,15084	7,732355	6,6277328	24,30169	91,68364				
	99	289	82	38	888	22	66	11	10	13	30	181				
	171	262	26	20	243	6	41	41	39	12	9	52				
	109	105	54	35	367	17	38	22	24	12	31	148				
	163	274	37	16	238	12	23	33	38	9	14	112				
	235	941	84	18	519	11	70	24	27	21	15	155				
Total (6-hour peak)	817	1,948	327	145	2,492	77	256	143	146	74	123	740	0	0	0	0
Average (6-hour peak)	136	325	55	24	415	13	43	24	24	12	21	123	0	0	0	0

Actual Pedestrian Crossing Distance (m)

Average 6-hour Peak Turning Movements

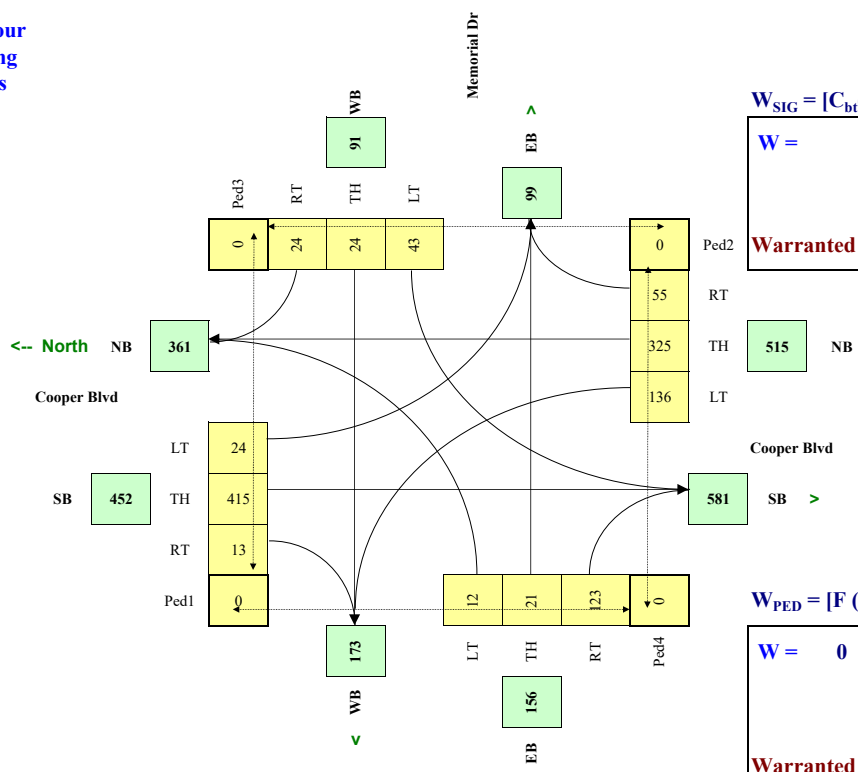

$$W_{SIG} = [C_{bt}(X_{v,v}) / K_1 + (F(X_{v,p}) L) / K_2] \times C_i$$

W =	116	116	0
		Veh	Ped

Warranted

RESET SHEET

$$W_{PED} = [F((X_{ped,m})d_m/K_2) + (X_{ped,s})d_s/K_3]$$

W =	0
-----	---

Warranted - Complex Intersection



Town of Gander - Traffic Signal & Pedestrian Signal Head Warrant Analysis

Main Street (name)	Cooper Boulevard	Direction (EW or NS)	NS	Road Authority:	Town of Gander
Side Street (name)	Raynham Avenue	Direction (EW or NS)	EW	City:	Town of Gander
Quadrant / Int #	3	Comments	Enter Comments about the analysis here.	Analysis Date:	2020 Feb 27, Thu
for Warrant Calculation Results, please hit 'Page Down'	CHECKSHEET			Count Date:	2018 Jun 14, Thu
				Date Entry Format:	(yyyy-mm-dd)

Lane Configuration		Excl LT	Th & LT	Through	Th+RT+LT	Th & RT	Excl RT	RT Channelization (y/n)	UpStream Signal (m)	# of Thru Lanes	LT Phase Type	RTOR Allowed (y/n)	Actuated Thru Phase
Cooper Boulevard	NB	1		1			1	y	1,500	1			
Cooper Boulevard	SB	1				1			5,000	1			
Raynham Avenue	WB				1				5,000	1			
Raynham Avenue	EB		1				1	n		1			

Saturation Flow Rates (if not default) (vphpl)	Default Saturation Flow Rates (vphpl)
Left Turn	1,650
Through	1,800
Right Turn	1,500

Are the Raynham Avenue WB right turns significantly impeded by through movements? (y/n) n

Are the Cooper Boulevard SB right turns significantly impeded by through movements? (y/n) n

Demographics		
Elem. School/Mobility Challenged	(y/n)	n
Senior's Complex	(y/n)	y
Pathway to School	(y/n)	y
Metro Area Population (#)		12,000
Central Business District	(y/n)	n

Other input	Speed (Km/h)	Truck %	Bus Rt (y/n)	Median (m)
Cooper Boulevard	NS	60		0.0
Raynham Avenue	EW		y	0.0

Traffic Input	NB			SB			WB			EB			Ped1 NS	Ped2 NS	Ped3 EW	Ped4 EW
	LT	Th	RT	LT	Th	RT	LT	Th	RT	LT	Th	RT	W Side	E Side	N Side	S Side
	7:00 - 8:00	49	89	21	4	181	15	24	9	2	12	8	177			
	95	130	43	11	436	20	116	29	11	6	15	262				
	203	115	56	4	149	22	36	10	6	10	10	108				
	150	103	24	10	140	17	50	17	2	10	20	151				
	308	431	128	8	255	33	75	27	13	12	45	130				
	154	147	52	4	133	29	35	8	11	11	14	86				
Total (6-hour peak)	959	1,015	325	42	1,294	136	337	99	45	61	112	914	0	0	0	0
Average (6-hour peak)	160	169	54	7	216	23	56	17	7	10	19	152	0	0	0	0

Average 6-hour Peak Turning Movements

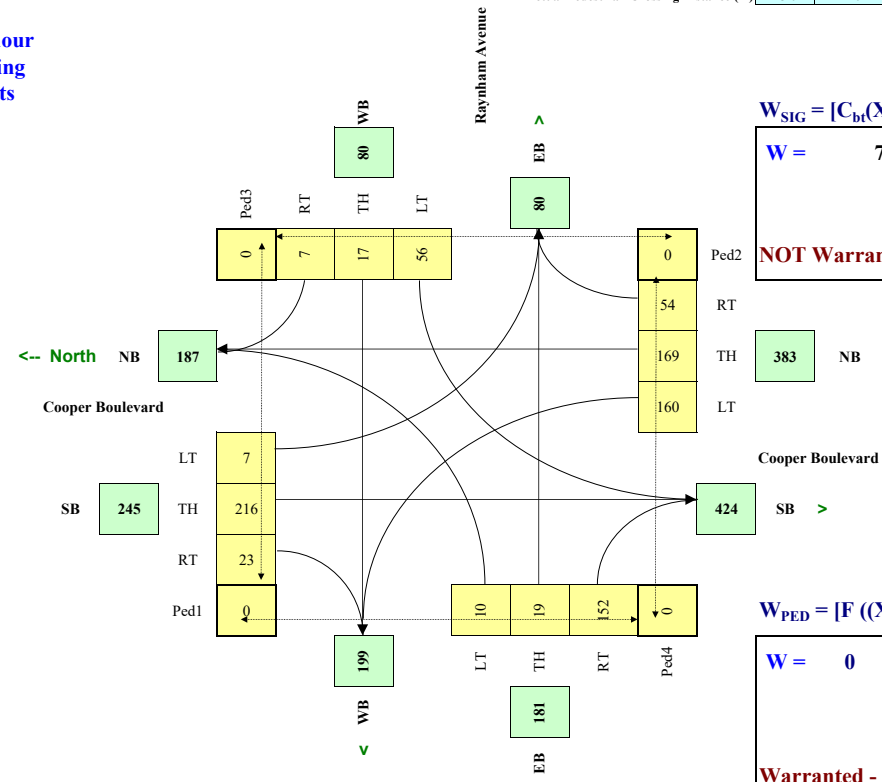

$$W_{SIG} = [C_{bt}(X_{v,v}) / K_1 + (F(X_{v,p}) L) / K_2] \times C_i$$

$W =$

75	75	0
	Veh	Ped

NOT Warranted

$$W_{PED} = [F((X_{ped,m})d_m/K_2) + (X_{ped,s})d_s/K_3]$$

$W =$

0

Warranted - Complex Intersection



Town of Gander - Traffic Signal & Pedestrian Signal Head Warrant Analysis

Main Street (name)	TCH 1	Direction (EW or NS)	EW	Road Authority:	Town of Gander
Side Street (name)	Cooper Blvd	Direction (EW or NS)	NS	City:	Town of Gander
Quadrant / Int #	9	Comments	Enter Comments about the analysis here.		
for Warrant Calculation Results, please hit 'Page Down'		CHECKSHEET		Analysis Date:	2020 Mar 01, Sun
				Count Date:	2019 Dec 04, Wed
				Date Entry Format:	(yyyy-mm-dd)

Lane Configuration	Excl LT	Th & LT	Through	Th+RT+LT	Th & RT	Excl RT	RT Channelization (y/n)	Upstream Signal (m)	# of Thru Lanes	LT Phase Type	RTOR Allowed (y/n)	Actuated Thru Phase
TCH 1	WB		1			1	y	2,000	1			
TCH 1	EB	1	1				n	2,000	1			
Cooper Blvd	NB							2,000	0			
Cooper Blvd	SB			1			y	1,200	1			

Saturation Flow Rates (if not default) (vphpl)	Default Saturation Flow Rates (vphpl)
Left Turn	1,650
Through	1,800
Right Turn	1,500

Are the Cooper Blvd SB right turns significantly impeded by through movements? (y/n)

n

n

n

Demographics		
Elem. School/Mobility Challenged	(y/n)	n
Senior's Complex	(y/n)	n
Pathway to School	(y/n)	n
Metro Area Population (#)		12,000
Central Business District	(y/n)	n

Other input	Speed (Km/h)	Truck %	Bus Rt (y/n)	Median (m)
TCH 1	EW	60	n	0.0
Cooper Blvd	NS		n	0.0

Set Peak Hours	NB				SB			WB			EB			Ped1 NS	Ped2 NS	Ped3 EW	Ped4 EW
	LT	Th	RT	LT	Th	RT	LT	Th	RT	LT	Th	RT	W Side	E Side	N Side	S Side	
	press 'Set Peak Hours' Button to set the peak hour periods	27.61555	0	0	86	0	195	0	83.95128	100.5206	136.97314	68.48657	0				
	88.36977	0	0	173.4257	0	113.7761	111.5668	153.54248	130.3454	0							
	100.5206	0	0	199.9366	0	113.7761	94.9975	129.24079	132.5547	0							
	0	0	0	278	0	527	0	101	181	342	130	0					
	129.2408	0	0	198.832	0	58.54497	65.17271	91.683636	78.42817	0							
Total (6-hour peak)	0	0	0	710	0	1,356	0	564	726	1,172	605	0	0	0	0	0	
Average (6-hour peak)	0	0	0	118	0	226	0	94	121	195	101	0	0	0	0	0	

Actual Pedestrian Crossing Distance (m)

25.0	27.0	12.0	
------	------	------	--

Average 6-hour Peak Turning Movements

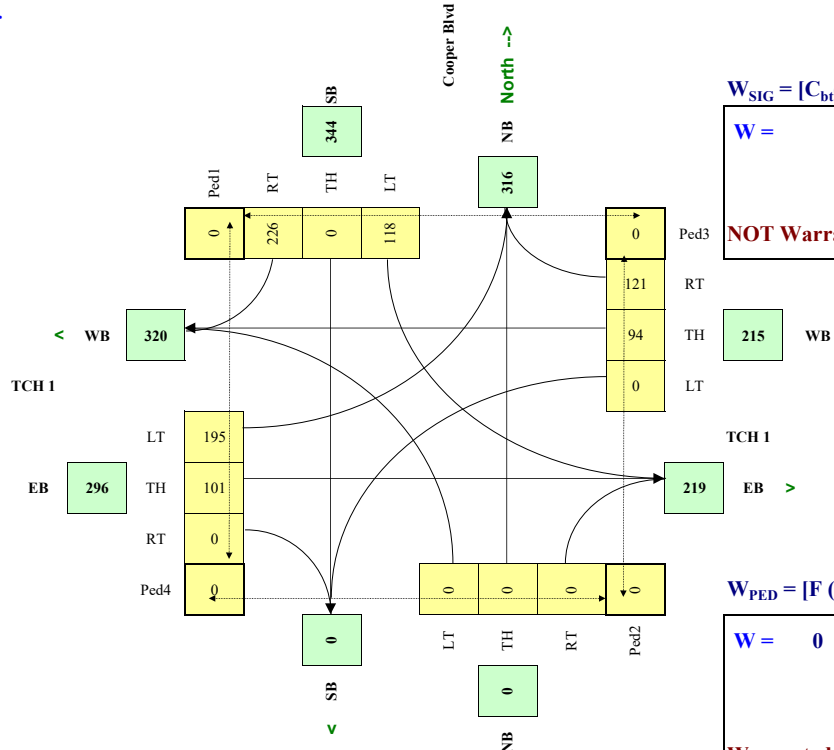

$$W_{SIG} = [C_{bt}(X_{v,v}) / K_1 + (F(X_{v,p})L) / K_2] \times C_i$$

W =	57	57	0
		Veh	Ped

NOT Warranted

RESET SHEET

$$W_{PED} = [F((X_{ped,m})d_m/K_2) + (X_{ped,s})d_s/K_3]$$

W =	0
-----	---

Warranted - Complex Intersection

APPENDIX D – COOPER BOULEVARD CONCEPT DESIGN PLAN

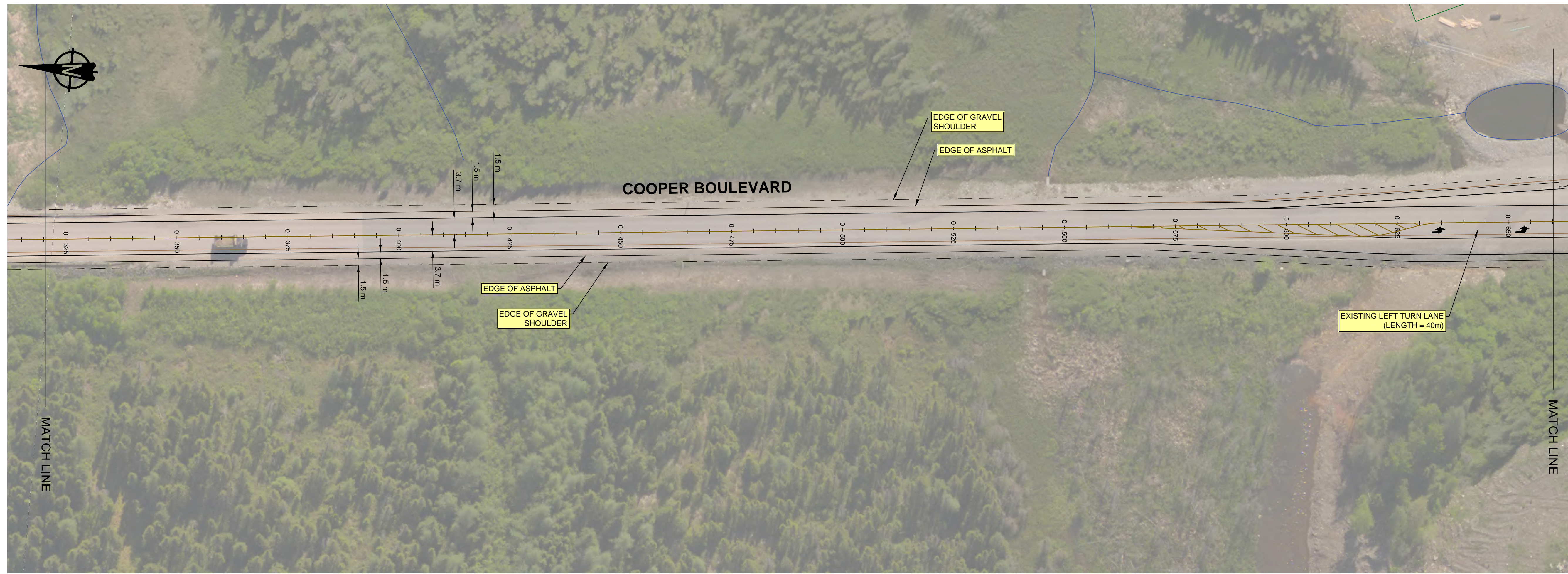
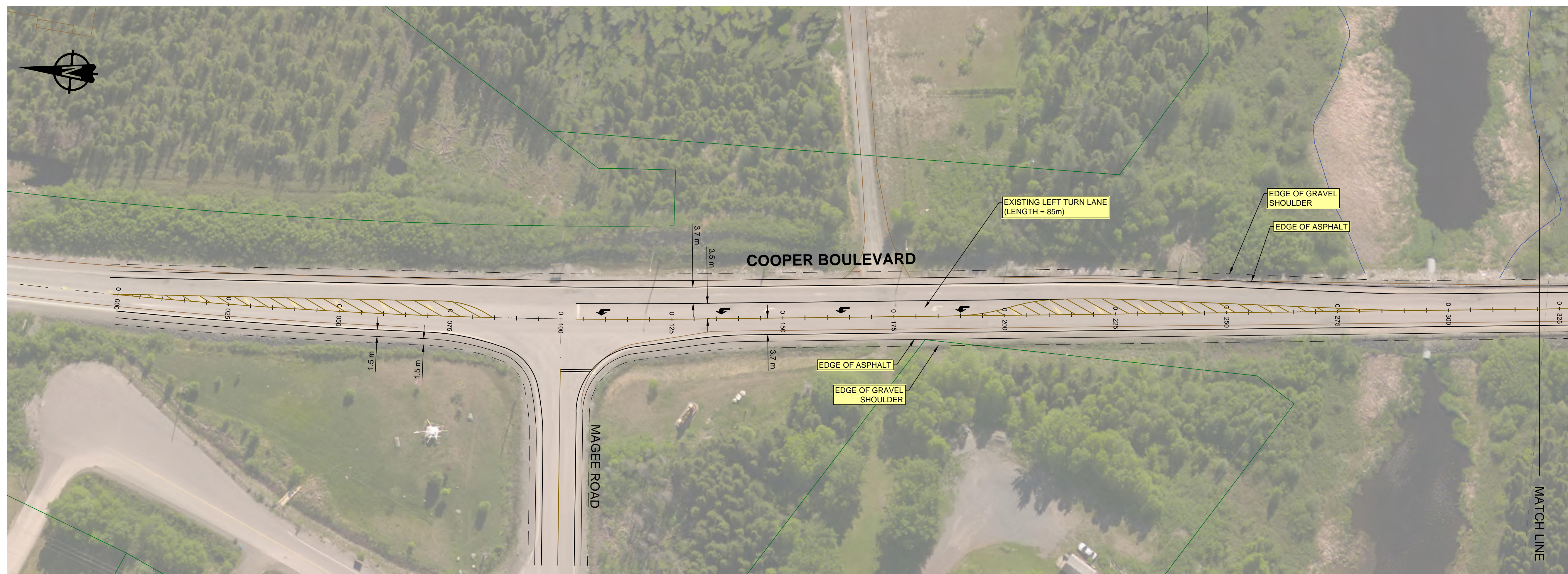

NOTES

A.O	MAY 12/20	REVISION	JTGB	PA
NO.	DATE	REVISIONS	BY	APPR.



PRELIMINARY ONLY
DATE PLOTTED: May 12, 2020
 NOT TO BE USED FOR CONSTRUCTION

PROJECT TITLE
**COOPER BOULEVARD
 TRANSPORTATION
 STUDY**

GANDER N.L.

DRAWING TITLE
**COOPER BOULEVARD
 CORRIDOR UPGRADE
 CONCEPT OPTION #1
 STN. 0+000 TO STN. 0+660**

Scale (1:500 FULL SCALE)	Drawn By	Design By
	Checked By	Cadd Check
	PA	JTGB
Sheet 1 of 14		

File Name
 1901214-1 CONCEPT OPTION 1.DWG

Drawing No.
T01

E:\COOPER\1901214-1 CONCEPT OPTION 1.DWG, 12/05/2020 9:44 AM

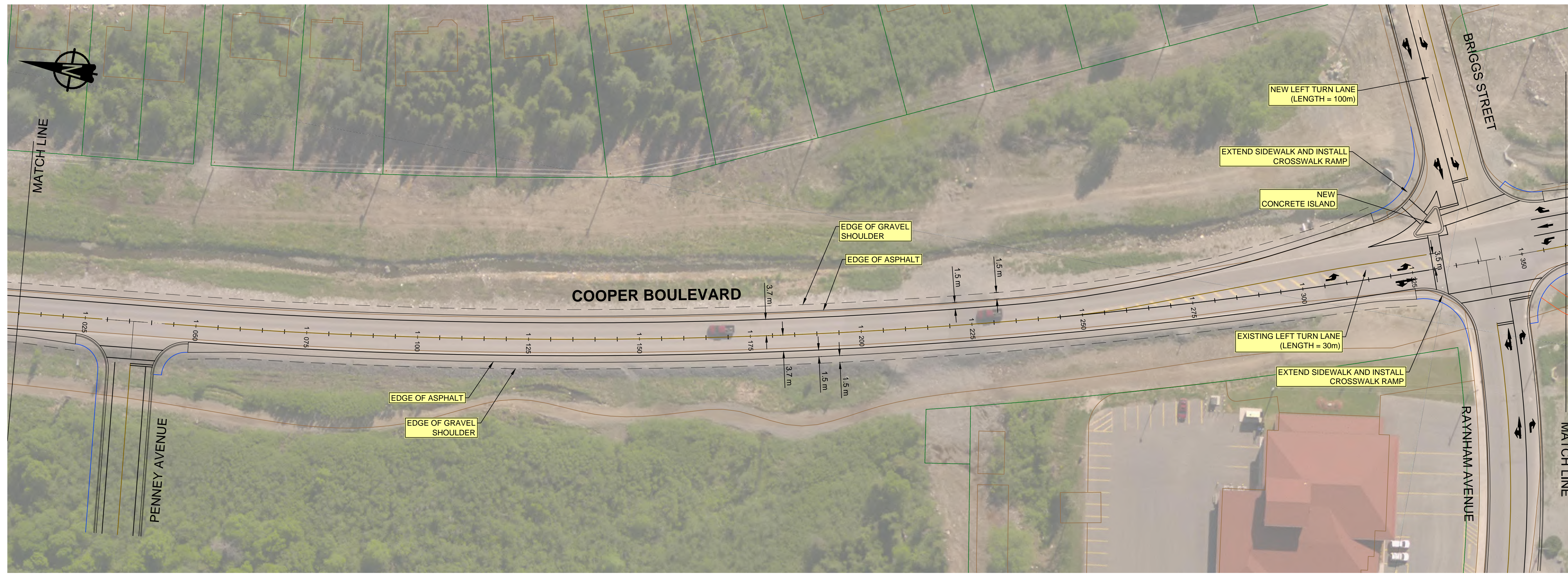

NOTES

A.O	MAY 12/20	REVISION	JTGB	PA
NO.	DATE	REVISIONS	BY	APPR.



PRELIMINARY ONLY
DATE PLOTTED: May 12, 2020
NOT TO BE USED FOR CONSTRUCTION

PROJECT TITLE
COOPER BOULEVARD TRANSPORTATION STUDY

GANDER N.L.
 DRAWING TITLE
COOPER BOULEVARD CORRIDOR UPGRADE CONCEPT OPTION #1 STN. 0+660 TO STN. 1+360

Scale 	Drawn By	Design By
	Checked By	Cadd Check
	PA	JTGB
Sheet 2 of 14		

File Name
 1901214-1 CONCEPT OPTION 1.DWG

Drawing No.
T02

E:\COOPER\1901214-1 CONCEPT OPTION 1.DWG, 12/05/2020 9:44 AM

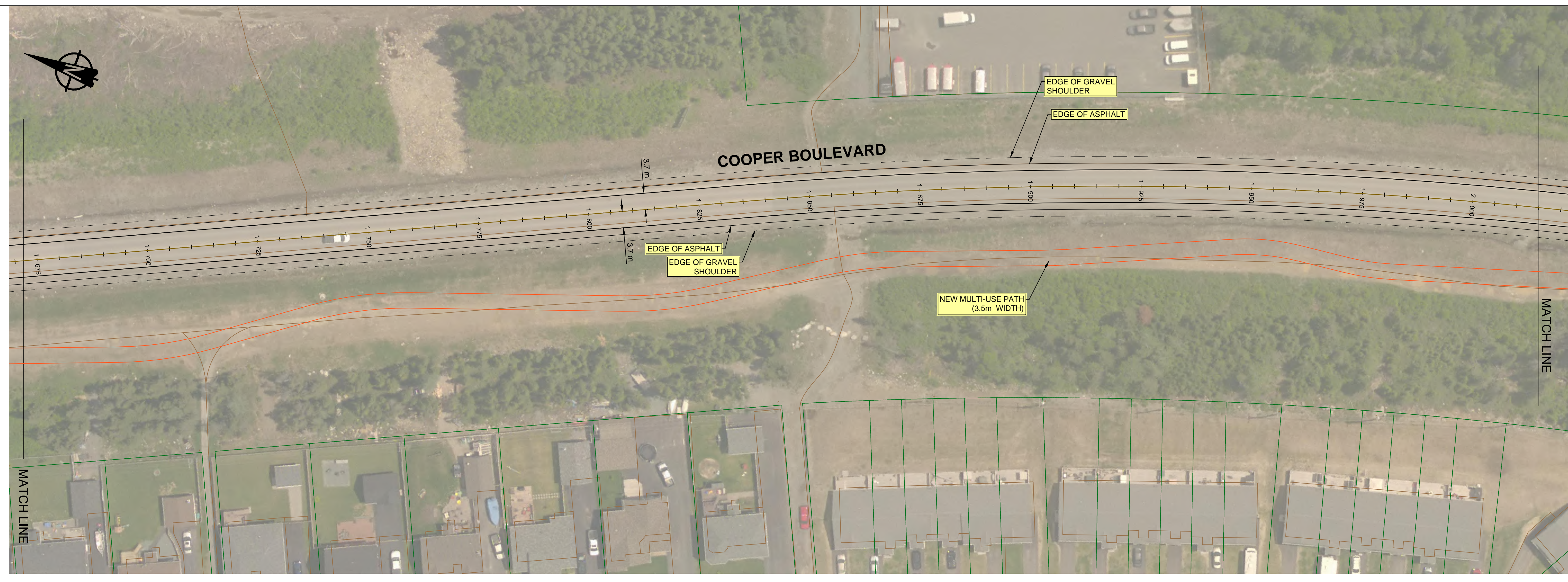
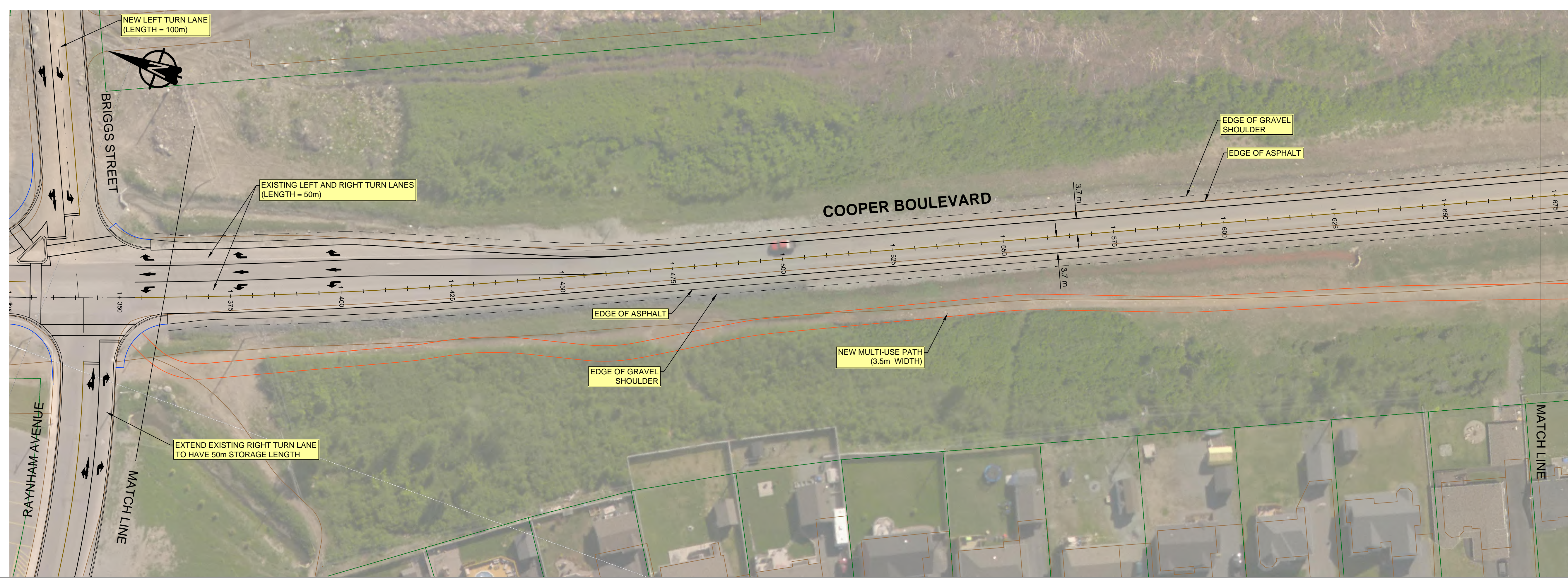

NOTES

A.O	MAY 12/20	REVISION	JTGB	PA
NO.	DATE	REVISIONS	BY	APPR.



PRELIMINARY ONLY
DATE PLOTTED: May 12, 2020
 NOT TO BE USED FOR CONSTRUCTION

PROJECT TITLE

**COOPER BOULEVARD
 TRANSPORTATION
 STUDY**

GANDER N.L.
 DRAWING TITLE

**COOPER BOULEVARD
 CORRIDOR UPGRADE
 CONCEPT OPTION #1
 STN. 1+360 TO STN. 2+015**

Scale (1:500 FULL SCALE)	Drawn By	Design By
	Checked By	Cadd Check
	Sheet	3 of 14

File Name
 1901214-1 CONCEPT OPTION 1.DWG

Drawing No.
T03

E:\COOPER\1901214-1 CONCEPT OPTION 1.DWG, 12/05/2020 9:43 AM

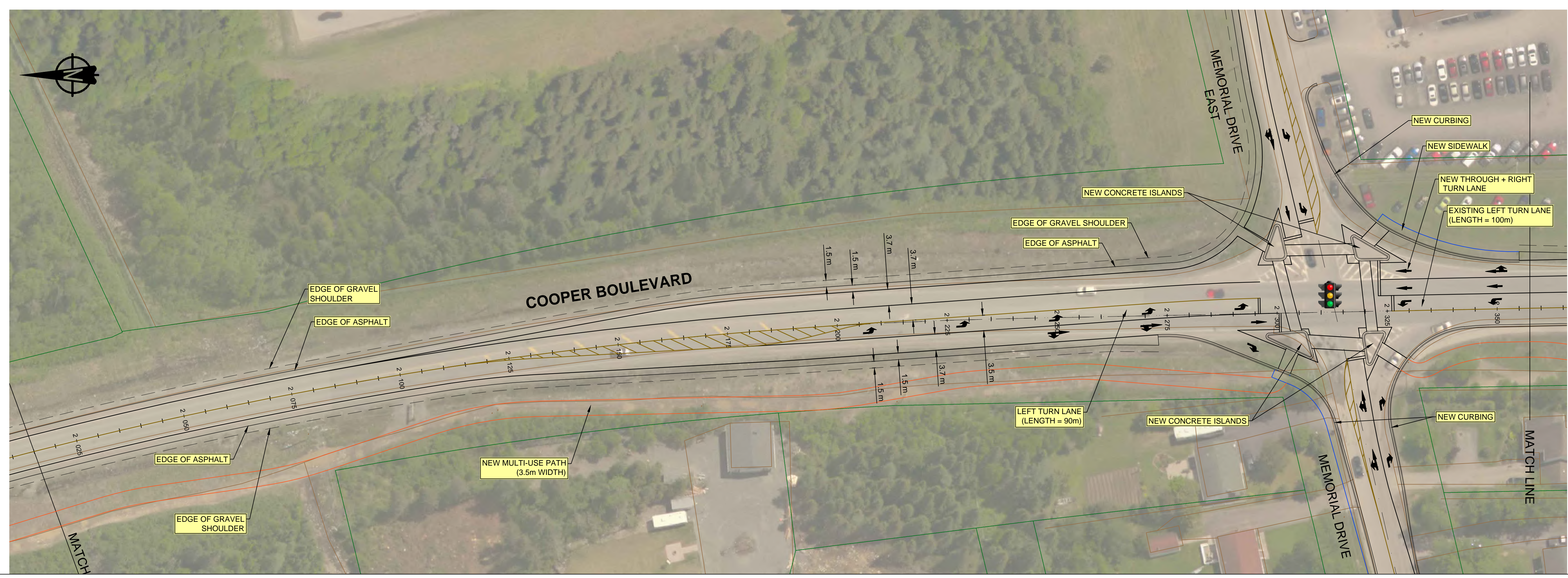

NOTES

A.O	MAY 12/20	REVISION	JTGB	PA
NO.	DATE	REVISIONS	BY	APPR.



PRELIMINARY ONLY
DATE PLOTTED: May 12, 2020
NOT TO BE USED FOR CONSTRUCTION

PROJECT TITLE
**COOPER BOULEVARD
 TRANSPORTATION
 STUDY**

GANDER N.L.
 DRAWING TITLE
**COOPER BOULEVARD
 CORRIDOR UPGRADE
 CONCEPT OPTION #1
 STN. 2+015 TO STN. 2+705**

Scale 	Drawn By	Design By
	Checked By	Cadd Check
	PA	JTGB
Sheet 4 of 14		

File Name
 1901214-1 CONCEPT OPTION 1.DWG

Drawing No.
T4

E:\COOPER\1901214-1 CONCEPT OPTION 1.DWG_12/05/2020 9:43 AM

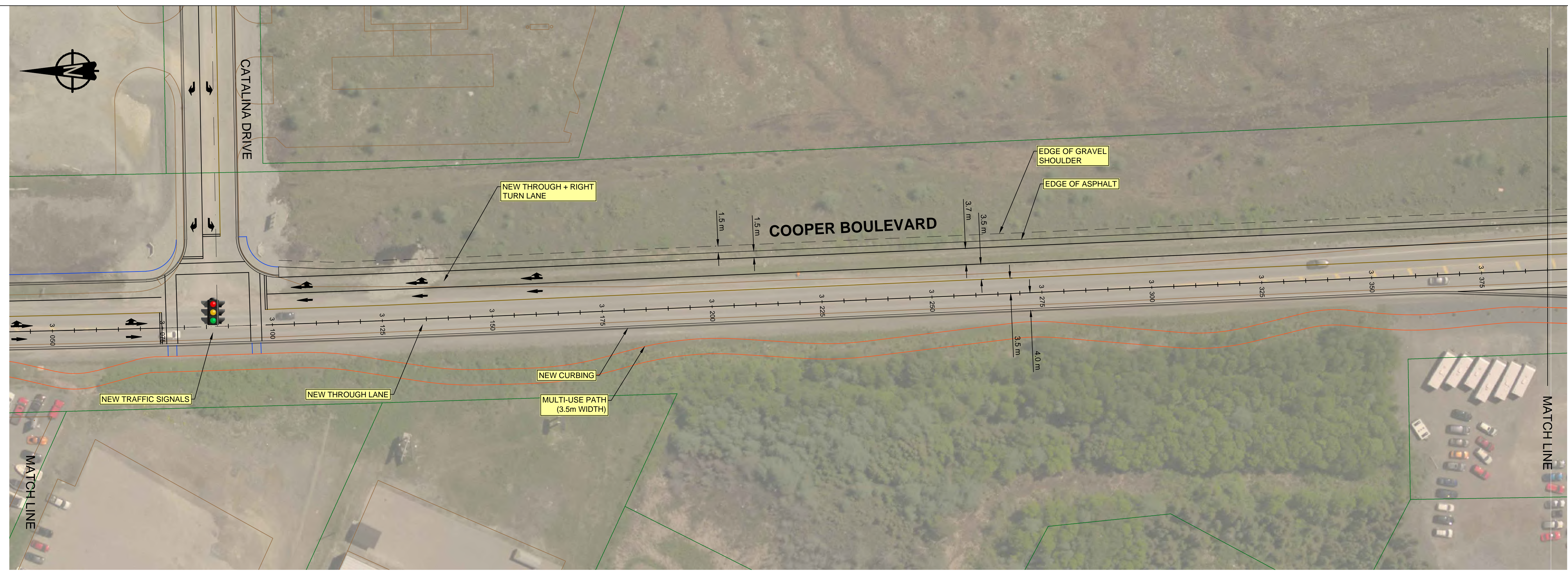
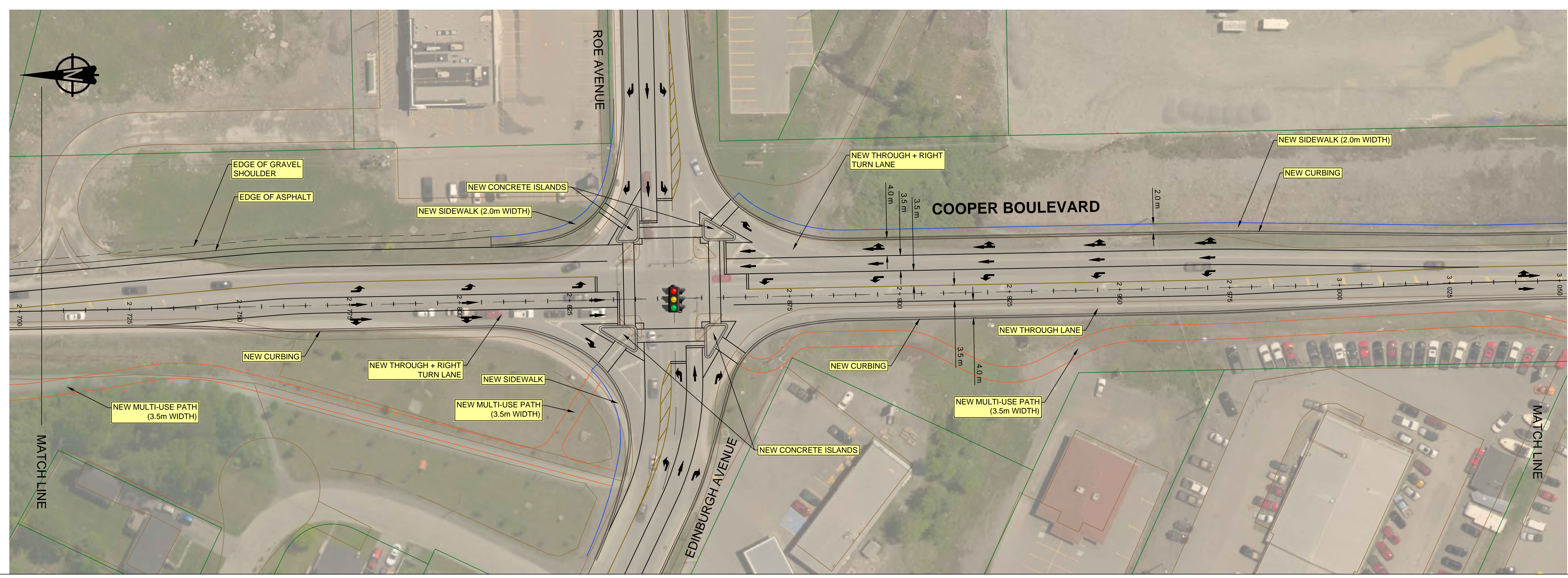

E:\COOPER\1901214-1 CONCEPT OPTION 1.DWG, 12/05/2020 9:42 AM

NOTES

A.O	MAY 12/20	REVISION	JTGB	PA
NO.	DATE	REVISIONS	BY	APPR.



PRELIMINARY ONLY
DATE PLOTTED: May 12, 2020
NOT TO BE USED FOR CONSTRUCTION

PROJECT TITLE

**COOPER BOULEVARD
 TRANSPORTATION
 STUDY**

GANDER N.L.

DRAWING TITLE

**COOPER BOULEVARD
 CORRIDOR UPGRADE
 CONCEPT OPTION #1
 STN. 2+705 TO STN. 3+390**

Scale (1:500 FULL SCALE)	Drawn By	Design By
	Checked By	Cadd Check
	Sheet	5 of 14

File Name
 1901214-1 CONCEPT OPTION 1.DWG

Drawing No.
T05

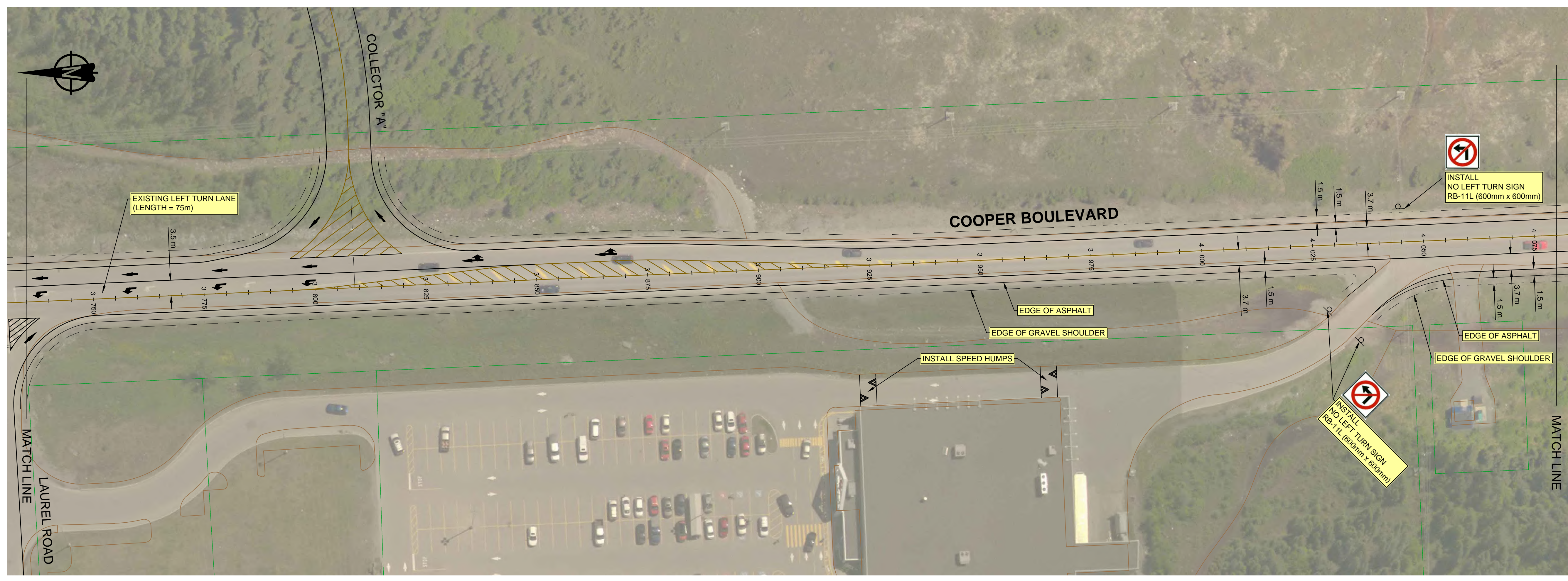
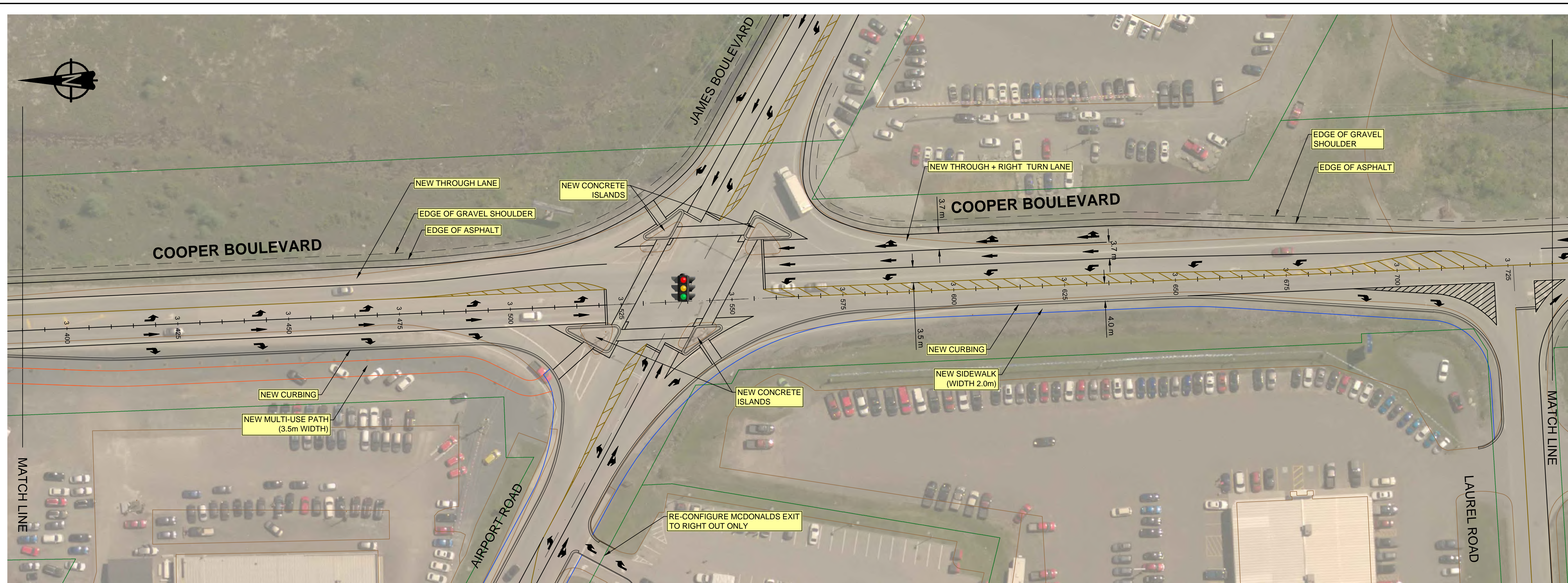

NOTES

A.O	MAY 12/20	REVISION	JTGB	PA
NO.	DATE	REVISIONS	BY	APPR.



PRELIMINARY ONLY
DATE PLOTTED: May 12, 2020
NOT TO BE USED FOR CONSTRUCTION

PROJECT TITLE

**COOPER BOULEVARD
 TRANSPORTATION
 STUDY**

GANDER N.L.

DRAWING TITLE

**COOPER BOULEVARD
 CORRIDOR UPGRADE
 CONCEPT OPTION #1
 STN. 3+390 TO STN. 4+080**

Scale (1:500 FULL SCALE)	Drawn By	Design By
	JTGB	JTGB
	Checked By	Cadd Check
	PA	JTGB
	Sheet	6 of 14

File Name
 1901214-1 CONCEPT OPTION 1.DWG

Drawing No.
 T06

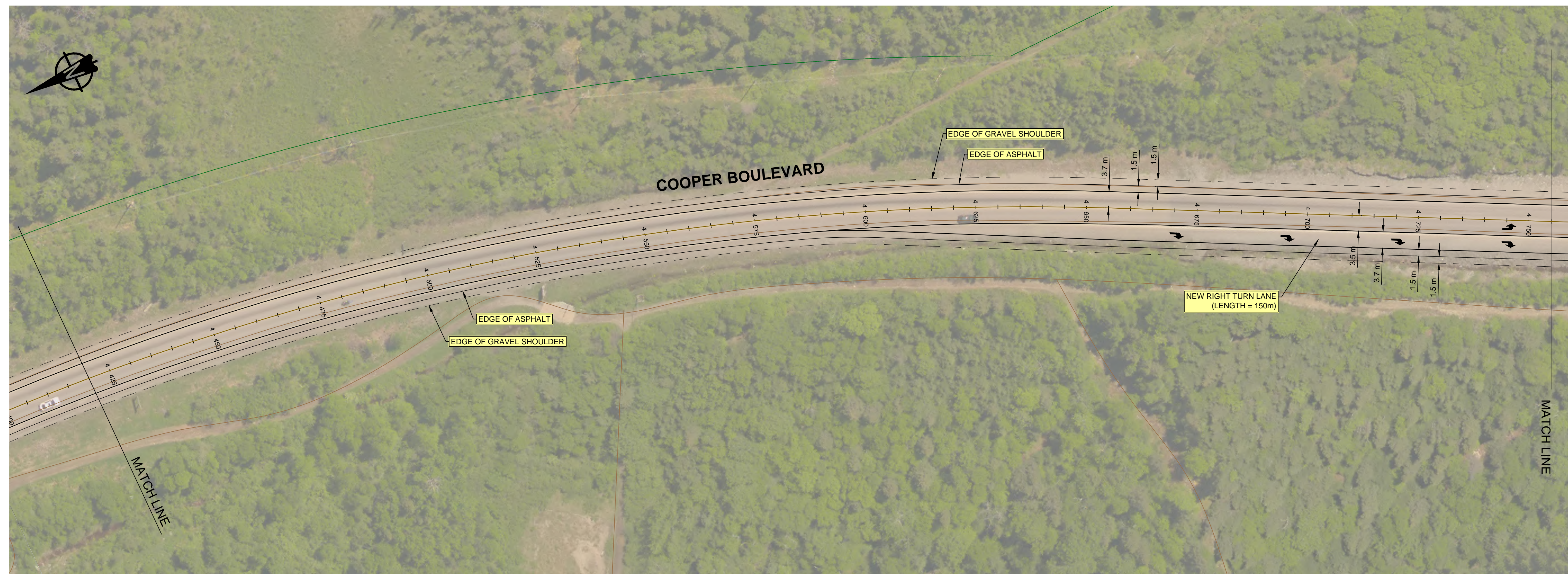
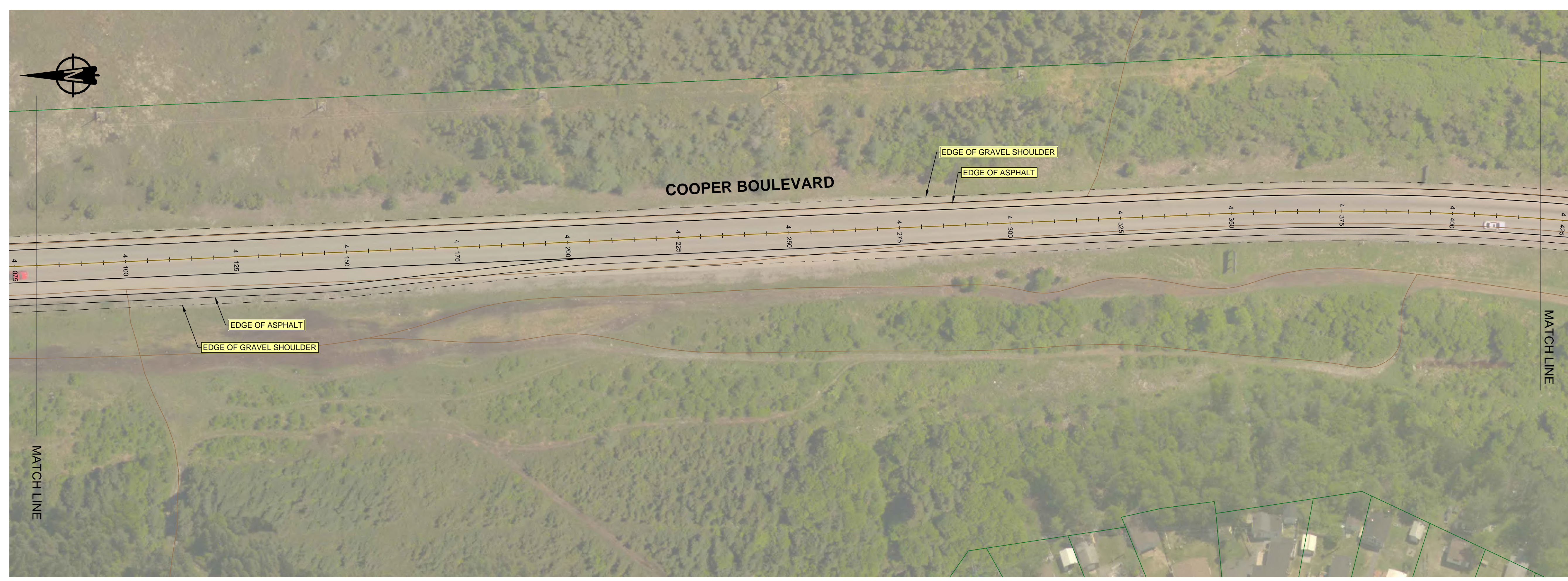

NOTES

A.O	MAY 12/20	REVISION	JTGB	PA
NO.	DATE	REVISIONS	BY	APPR.



PRELIMINARY ONLY
DATE PLOTTED: May 12, 2020
NOT TO BE USED FOR CONSTRUCTION

PROJECT TITLE
**COOPER BOULEVARD
 TRANSPORTATION
 STUDY**

GANDER N.L.

DRAWING TITLE
**COOPER BOULEVARD
 CORRIDOR UPGRADE
 CONCEPT OPTION #1
 STN. 4+080 TO STN. 4+755**

Scale (1:500 FULL SCALE)	Drawn By	Design By
	Checked By	Cadd Check
	PA	JTGB
Sheet		7 of 14

File Name
 1901214-1 CONCEPT OPTION 1.DWG

Drawing No.
T07

E:\COOPER\1901214-1 CONCEPT OPTION 1.DWG_12/05/2020 9:40 AM

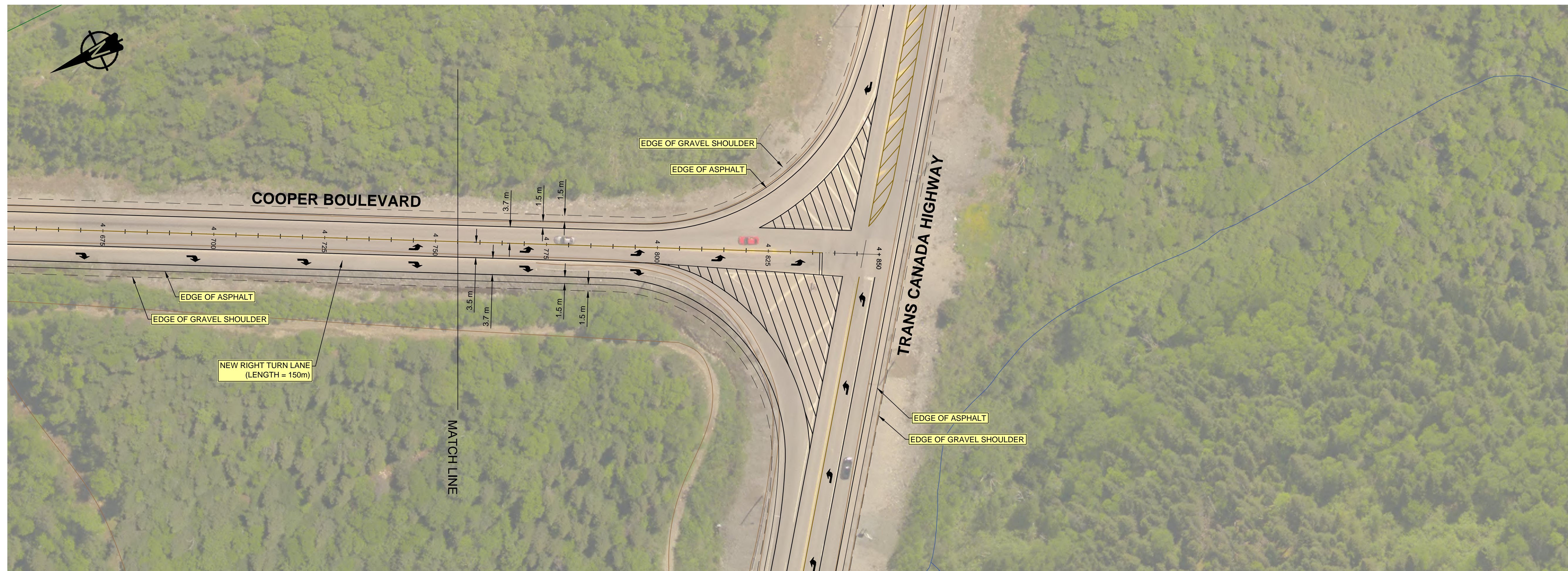

NOTES

A.0	MAY 12/20	REVISION	JTGB	PA
NO.	DATE	REVISIONS	BY	APPR.



PRELIMINARY ONLY
DATE PLOTTED: May 12, 2020
NOT TO BE USED FOR CONSTRUCTION

PROJECT TITLE
**COOPER BOULEVARD
 TRANSPORTATION
 STUDY**

GANDER N.L.

DRAWING TITLE
**COOPER BOULEVARD
 CORRIDOR UPGRADE
 CONCEPT OPTION #1
 STN. 4+755 TO STN. 4+850**

Scale 	Drawn By	Design By
	Checked By	Cadd Check
	PA	JTGB
Sheet		8 of 14

File Name
 1901214-1 CONCEPT OPTION 1.DWG

Drawing No.
T08



NOTES

A.O	MAY 12/20	REVISION	JTGB	PA
NO.	DATE	REVISIONS	BY	APPR.

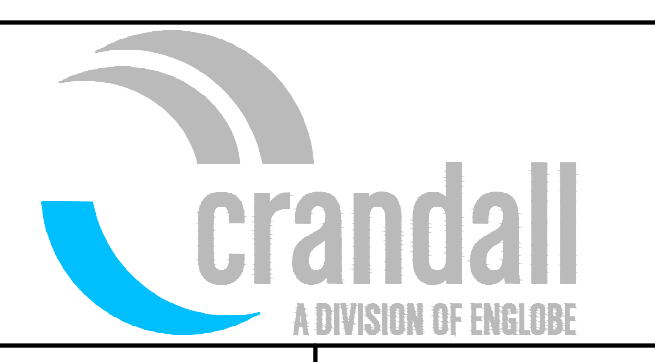

PRELIMINARY ONLY
DATE PLOTTED: May 12, 2020
NOT TO BE USED FOR CONSTRUCTION

PROJECT TITLE
**COOPER BOULEVARD
 TRANSPORTATION
 STUDY**

GANDER N.L.
 DRAWING TITLE
**COOPER BOULEVARD
 CORRIDOR UPGRADE
 CONCEPT OPTION #1
 COOPER BLVD. / MEMORIAL DR.**

Scale (1:500 FULL SCALE)	Drawn By	Design By
	JTGB	JTGB
	Checked By	Cadd Check
	PA	JTGB
	Sheet	9 of 14

File Name
 1901214-1 CONCEPT OPTION 1.DWG

Drawing No.
T09

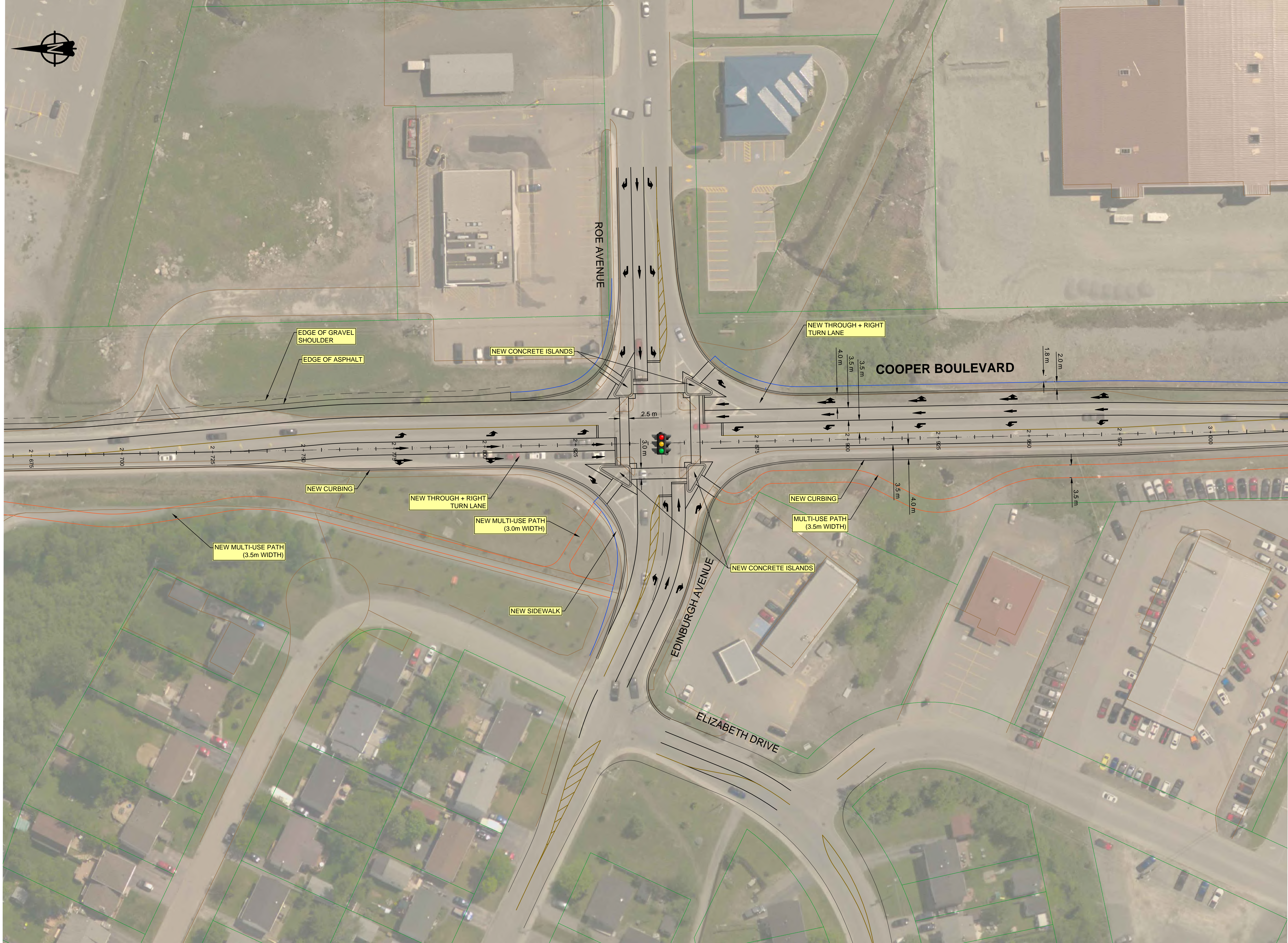

NOTES

A.O	MAY 12/20	REVISION	JTGB	PA
NO.	DATE	REVISIONS	BY	APPR.



PRELIMINARY ONLY
DATE PLOTTED: May 12, 2020
 NOT TO BE USED FOR CONSTRUCTION

PROJECT TITLE
**COOPER BOULEVARD
 TRANSPORTATION
 STUDY**

GANDER N.L.
 DRAWING TITLE
**COOPER BOULEVARD
 CORRIDOR UPGRADE
 CONCEPT OPTION #1
 COOPER BLVD. / ROE AVE. /
 EDINBURGH AVE.**

Scale 2.5m 0 5m (1:250 FULL SCALE)	Drawn By	Design By
	JTGB	JTGB
	Checked By	Cadd Check
	PA	JTGB
	Sheet	10 of 14

File Name
 1901214-1 CONCEPT OPTION 1.DWG

Drawing No.
T10

E:\COOPER\1901214-1 CONCEPT OPTION 1.DWG_12/05/2020 9:41 AM

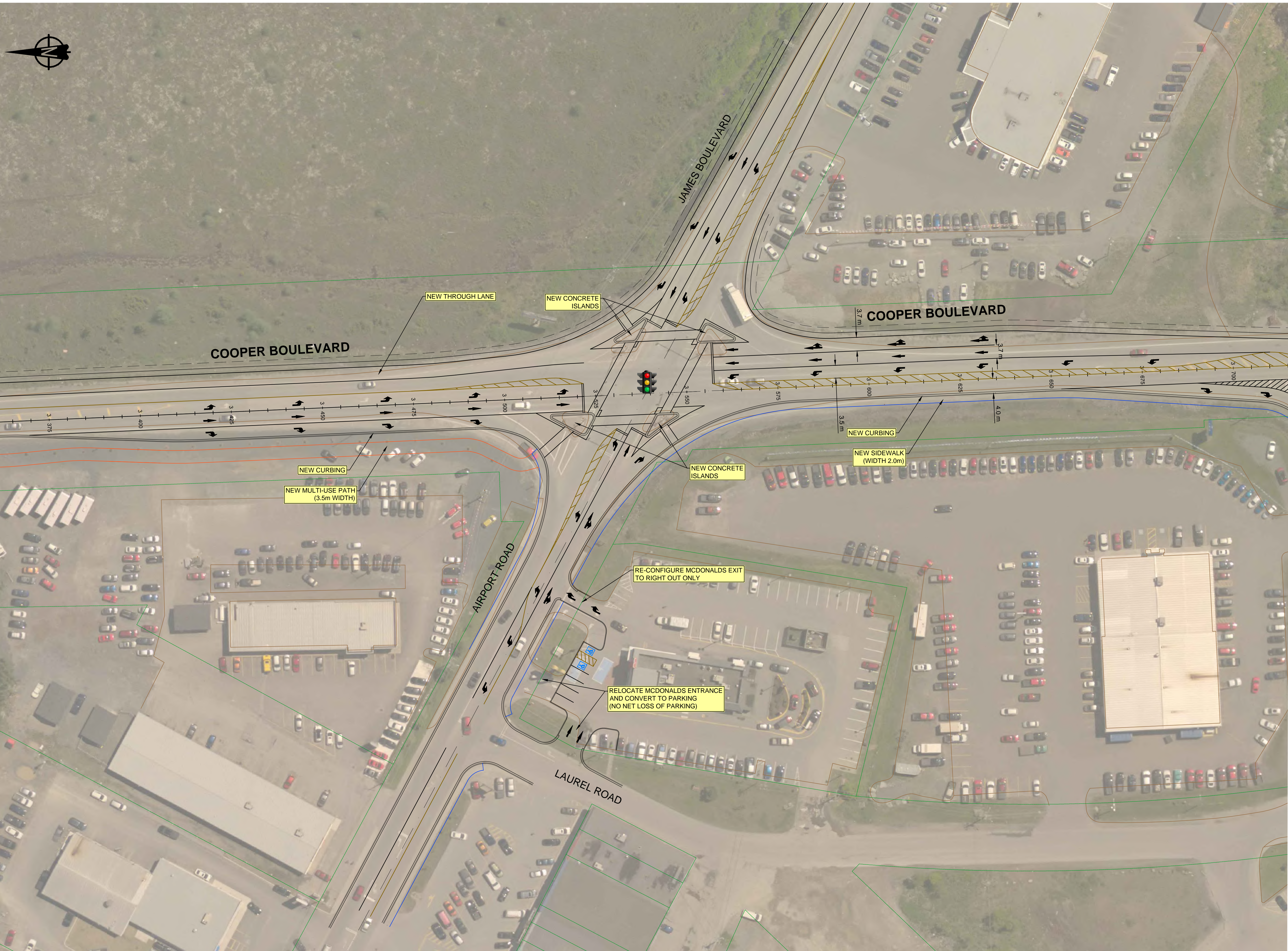

E:\COOPER\1901214-1 CONCEPT OPTION 1.DWG, 12/05/2020 9:42 AM

NOTES

A.O	MAY 12/20	REVISION	JTGB	PA
NO.	DATE	REVISIONS	BY	APPR.



PRELIMINARY ONLY
DATE PLOTTED: May 12, 2020
 NOT TO BE USED FOR CONSTRUCTION

PROJECT TITLE

**COOPER BOULEVARD
 TRANSPORTATION
 STUDY**

GANDER N.L.

DRAWING TITLE
**COOPER BOULEVARD
 CORRIDOR UPGRADE
 CONCEPT OPTION #1
 COOPER BLVD. / AIRPORT RD. /
 JAMES BLVD.**

Scale 	Drawn By	Design By
	Checked By	Cadd Check
	PA	JTGB
Sheet 11 of 14		

File Name
 1901214-1 CONCEPT OPTION 1.DWG

Drawing No.
T11

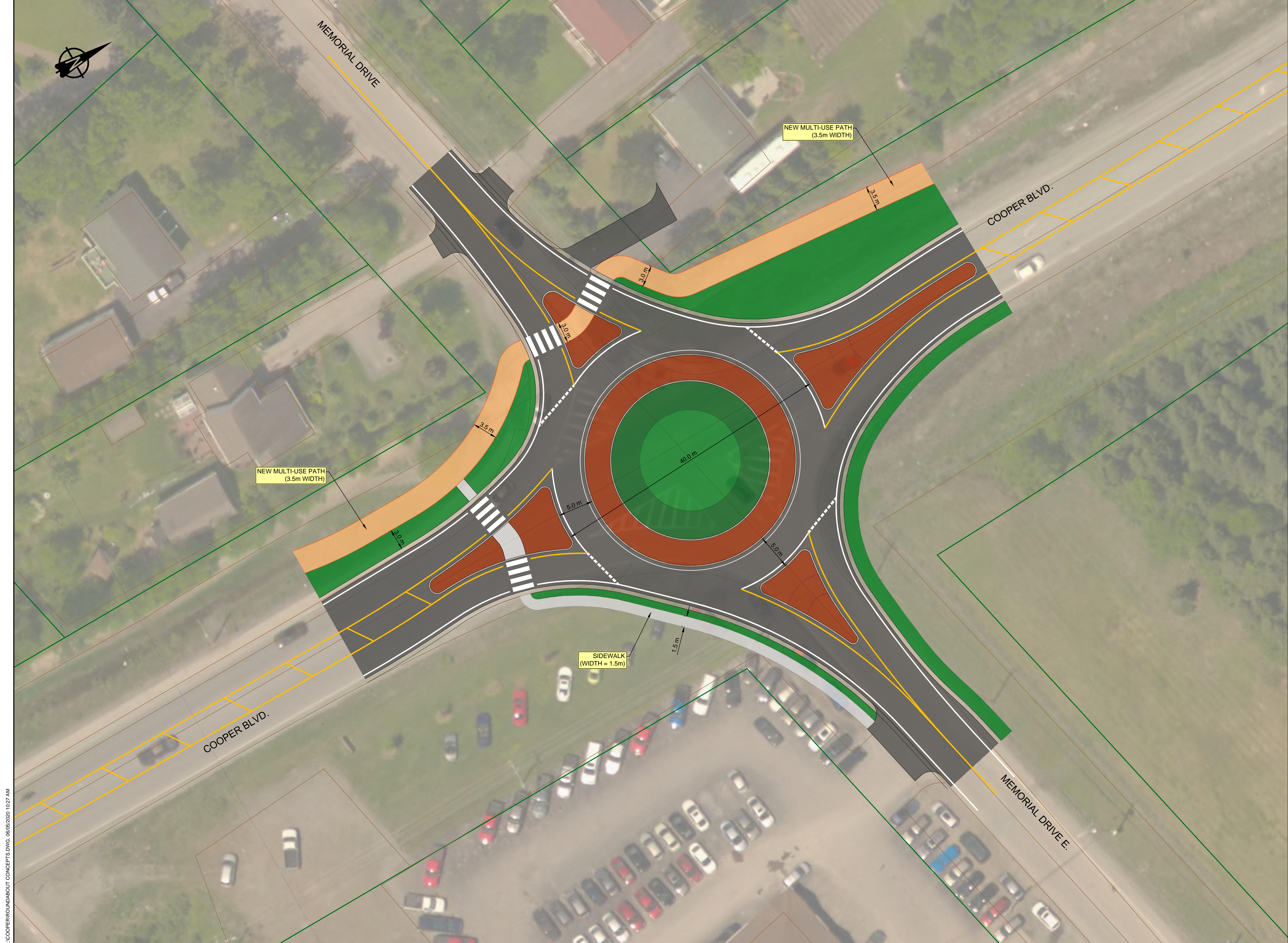

NOTES

A.0	MAY 06/20	REVISION	JTGB	PA
NO.	DATE	REVISIONS	BY	APPR.



PRELIMINARY ONLY
DATE PLOTTED: May 06, 2020
 NOT TO BE USED FOR CONSTRUCTION

PROJECT TITLE

COOPER BOULEVARD
TRAFFIC STUDY

GANDER N.L.

DRAWING TITLE
 COOPER BOULEVARD
 CORRIDOR UPGRADE
 CONCEPT OPTION #2
 COOPER BLVD / MEMORIAL DR.
 ROUNDABOUT CONCEPT

Scale 	Drawn By	Design By
	AB	ALAN B
	Checked By	Cadd Check
	AB	AB
	Sheet	12 of 14

File Name
ROUNDABOUT CONCEPTS.DWG

Drawing No.
T12

E:\COOPERROUNDABOUT CONCEPTS.DWG, 06/05/2020 10:27 AM



C:\2019\1801214-00-COOPER BOULEVARD TRAFFIC STUDY\DESIGN\DRAWINGS\COOPER-ROE OPTION 2.DWG, 06/05/2020 9:33 AM

NOTES

A.O	MAY 06/20	REVISION	JTGB	PA
NO.	DATE	REVISIONS	BY	APPR.



PRELIMINARY ONLY
DATE PLOTTED: May 06, 2020
NOT TO BE USED FOR CONSTRUCTION

PROJECT TITLE

COOPER BOULEVARD TRAFFIC STUDY

GANDER N.L.

DRAWING TITLE
COOPER BOULEVARD CORRIDOR UPGRADE CONCEPT OPTION #2 COOPER BLVD / ROE AVE. ROUNDABOUT CONCEPT

Scale 	Drawn By	Design By
	AB	ALAN B
	Checked By	Cadd Check
	AB	AB
	Sheet	13 of 14

File Name
 COOPER-ROE OPTION 2.DWG

Drawing No.
T13

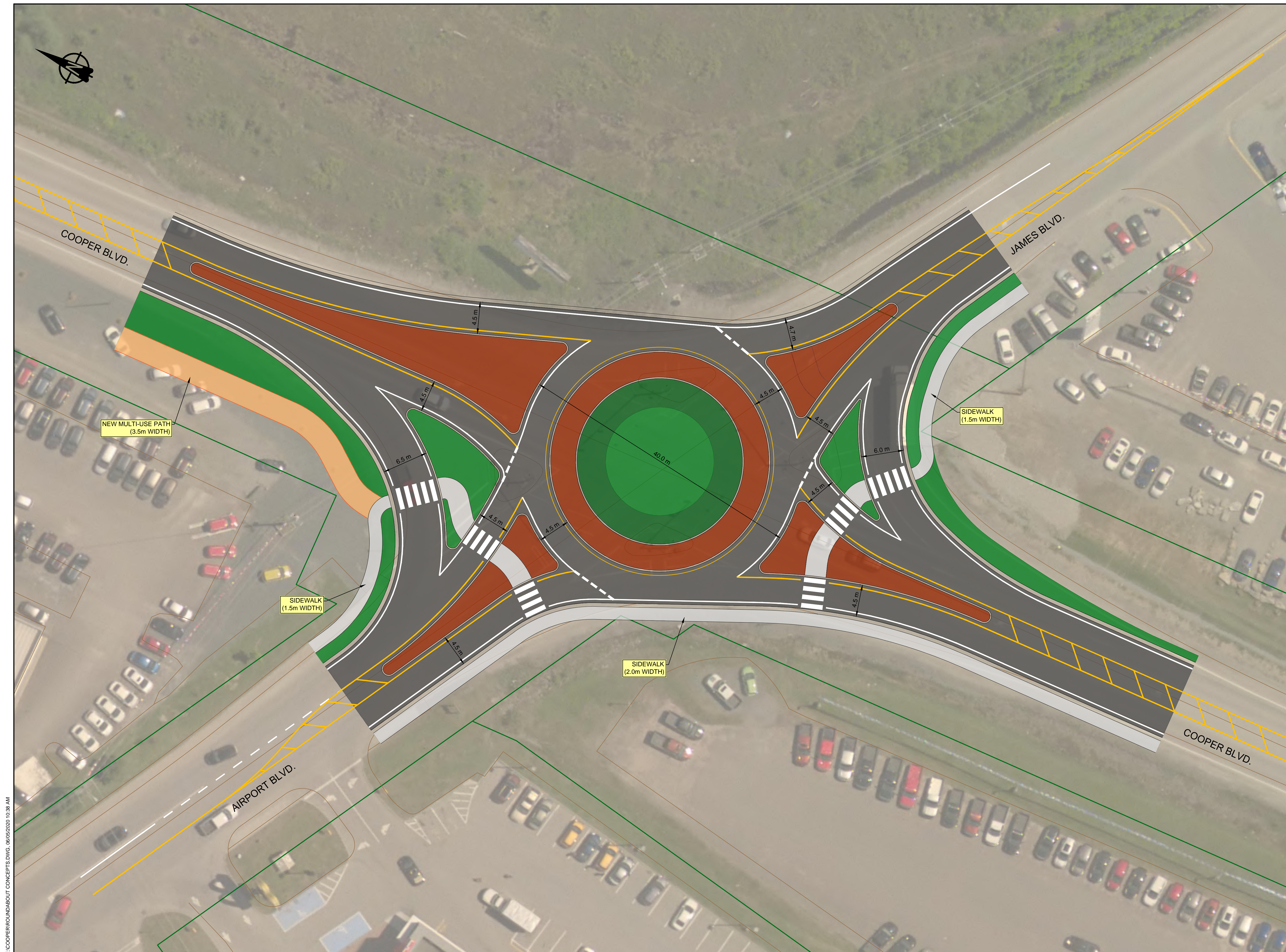

E:\COOPER\ROUNDABOUT CONCEPTS.DWG, 06/05/2020 10:38 AM

NOTES

A.O	MAY 06/20	REVISION	JTGB	PA
NO.	DATE	REVISIONS	BY	APPR.



PRELIMINARY ONLY
DATE PLOTTED: May 06, 2020
 NOT TO BE USED FOR CONSTRUCTION

PROJECT TITLE

**COOPER BOULEVARD
TRAFFIC STUDY**

GANDER N.L.

DRAWING TITLE
**COOPER BOULEVARD
CORRIDOR UPGRADE
CONCEPT OPTION #2
COOPER BLVD / AIRPORT BLVD.
ROUNDBOUT CONCEPT**

Scale 	Drawn By	Design By
	AB	ALAN B
	Checked By	Cadd Check
	AB	AB
	Sheet	14 of 14

File Name
 ROUNDABOUT CONCEPTS.DWG

Drawing No.
T14

APPENDIX E – COOPER BOULEVARD CONSTRUCTION COST ESTIMATES

Town of Gander
1901214 - Cooper Boulevard Transportation Study
Cooper Blvd-Raynham Avenue - Northeast Concrete Island for Pedestrian Crossing
Class D Cost Estimate - May 12, 2020

Item No.	Description	Unit	Unit Price	Estimated Quantity	Total Cost
Removals					
1	Common Excavation	LS	\$1,000.00	1	\$1,000.00
2	Curb and Gutter Removal	m	\$15.00	25	\$375.00
3	Sidewalk Removal	m2	\$20.00	40	\$800.00
4	Saw Cut Asphalt	m	\$10.00	60	\$600.00
5	Asphalt Removal	m2	\$10.00	30	\$300.00
6	Asphalt Cold Milling - 50mm depth	m2	\$10.00	30	\$300.00
Roadway Construction					
7	New Concrete Curb and Gutter	m	\$120.00	45	\$5,400.00
8	Storm Sewer	LS	\$10,000.00	0	\$0.00
9	New Concrete Sidewalk	m2	\$120.00	50	\$6,000.00
10	New Concrete Island	m2	\$120.00	20	\$2,400.00
11	Rock Borrow (100mm Minus Rock Fill)	t	\$15.00	0	\$0.00
12	Aggregate Sub-Base (Granular B 150mm)	t	\$22.00	10	\$220.00
13	Aggregate Base (Granular A 100mm)	t	\$25.00	6	\$150.00
14	Asphaltic Concrete Base (60mm Thickness)	t	\$140.00	20	\$2,800.00
15	Asphaltic Concrete Seal (40mm Thickness)	t	\$150.00	15	\$2,250.00
16	Topsoil and Hydroseed	m2	\$12.00	0	\$0.00
17	Traffic Signal Installation (Complete)	LS	\$200,000.00	0.0	\$0.00
18	Pavement Markings and Signage	lumpsum	\$2,500.00	1	\$2,500.00
19	Utility Pole Relocations Allowance	lumpsum	\$0.00	1	\$0.00
				SUBTOTAL	\$25,100.00
				Contingency (20% of subtotal)	\$5,020.00
TOTAL(excluding engineering and tax)					\$30,100.00

Town of Gander
 1901214 - Cooper Boulevard Transportation Study
 Cooper Blvd-Memorial Dr - Traffic Signal Installation and Intersection Upgrade
 Class D Cost Estimate - May 12, 2020

Item No.	Description	Unit	Unit Price	Estimated Quantity	Total Cost
Removals					
1	Common Excavation	LS	\$5,000.00	1	\$5,000.00
2	Curb and Gutter Removal	m	\$15.00	100	\$1,500.00
3	Sidewalk Removal	m2	\$20.00	200	\$4,000.00
4	Saw Cut Asphalt	m	\$10.00	900	\$9,000.00
5	Asphalt Removal	m2	\$10.00	1400	\$14,000.00
6	Asphalt Cold Milling - 50mm depth	m2	\$10.00	4500	\$45,000.00
Roadway Construction					
7	New Concrete Curb and Gutter	m	\$120.00	340	\$40,800.00
8	Storm Sewer	LS	\$10,000.00	1	\$10,000.00
9	New Concrete Sidewalk	m2	\$120.00	85	\$10,200.00
10	New Concrete Island	m2	\$120.00	120	\$14,400.00
11	Rock Borrow (100mm Minus Rock Fill)	t	\$15.00	4500	\$67,500.00
12	Aggregate Sub-Base (Granular B 150mm)	t	\$22.00	800	\$17,600.00
13	Aggregate Base (Granular A 100mm)	t	\$25.00	500	\$12,500.00
14	Asphaltic Concrete Base (60mm Thickness)	t	\$140.00	530	\$74,200.00
15	Asphaltic Concrete Seal (40mm Thickness)	t	\$150.00	790	\$118,500.00
16	Topsoil and Hydroseed	m2	\$12.00	2000	\$24,000.00
17	Traffic Signal Installation (Complete)	LS	\$200,000.00	1.0	\$200,000.00
18	Pavement Markings and Signage	lumpsum	\$15,000.00	1	\$15,000.00
19	Utility Pole Relocations Allowance	lumpsum	\$15,000.00	1	\$15,000.00
				SUBTOTAL	\$698,200.00
				Contingency (20% of subtotal)	\$139,640.00
TOTAL(excluding engineering and tax)					\$837,800.00

Town of Gander
 1901214 - Cooper Boulevard Transportation Study
 Cooper Blvd-Roe Ave - Signalized Intersection Upgrade
 Class D Cost Estimate - May 12, 2020

Item No.	Description	Unit	Unit Price	Estimated Quantity	Total Cost
Removals					
1	Common Excavation	LS	\$5,000.00	1	\$5,000.00
2	Curb and Gutter Removal	m	\$15.00	330	\$4,950.00
3	Sidewalk Removal	m2	\$20.00	415	\$8,300.00
4	Saw Cut Asphalt	m	\$10.00	1000	\$10,000.00
5	Asphalt Removal	m2	\$10.00	500	\$5,000.00
6	Asphalt Cold Milling - 50mm depth	m2	\$10.00	7000	\$70,000.00
Roadway Construction					
7	New Concrete Curb and Gutter	m	\$120.00	740	\$88,800.00
8	Storm Sewer	LS	\$20,000.00	1	\$20,000.00
9	New Concrete Sidewalk	m2	\$120.00	550	\$66,000.00
10	New Concrete Island	m2	\$120.00	70	\$8,400.00
11	Rock Borrow (100mm Minus Rock Fill)	t	\$15.00	1600	\$24,000.00
12	Aggregate Sub-Base (Granular B 150mm)	t	\$22.00	500	\$11,000.00
13	Aggregate Base (Granular A 100mm)	t	\$25.00	400	\$10,000.00
14	Asphaltic Concrete Base (60mm Thickness)	t	\$140.00	340	\$47,600.00
15	Asphaltic Concrete Seal (40mm Thickness)	t	\$150.00	1030	\$154,500.00
16	Topsoil and Hydroseed	m2	\$12.00	2000	\$24,000.00
17	Traffic Signal Installation (Complete)	LS	\$175,000.00	1.0	\$175,000.00
18	Pavement Markings and Signage	lumpsum	\$15,000.00	1	\$15,000.00
19	Utility Pole Relocations Allowance	lumpsum	\$15,000.00	1	\$15,000.00
				SUBTOTAL	\$762,550.00
				Contingency (20% of subtotal)	\$152,510.00
TOTAL(excluding engineering and tax)					\$915,100.00

Town of Gander
1901214 - Cooper Boulevard Transportation Study
Cooper Blvd-Catalina Dr - Traffic Signal Installation and Intersection Upgrade
Class D Cost Estimate - May 12, 2020

Item No.	Description	Unit	Unit Price	Estimated Quantity	Total Cost
Removals					
1	Common Excavation	LS	\$5,000.00	1	\$5,000.00
2	Curb and Gutter Removal	m	\$15.00	15	\$225.00
3	Sidewalk Removal	m2	\$20.00	25	\$500.00
4	Saw Cut Asphalt	m	\$10.00	610	\$6,100.00
5	Asphalt Removal	m2	\$10.00	300	\$3,000.00
6	Asphalt Cold Milling - 50mm depth	m2	\$10.00	3000	\$30,000.00
Roadway Construction					
7	New Concrete Curb and Gutter	m	\$120.00	360	\$43,200.00
8	Storm Sewer	LS	\$50,000.00	1	\$50,000.00
9	New Concrete Sidewalk	m2	\$120.00	120	\$14,400.00
10	New Concrete Island	m2	\$120.00	0	\$0.00
11	Rock Borrow (100mm Minus Rock Fill)	t	\$15.00	4400	\$66,000.00
12	Aggregate Sub-Base (Granular B 150mm)	t	\$22.00	800	\$17,600.00
13	Aggregate Base (Granular A 100mm)	t	\$25.00	900	\$22,500.00
14	Asphaltic Concrete Base (60mm Thickness)	t	\$140.00	310	\$43,400.00
15	Asphaltic Concrete Seal (40mm Thickness)	t	\$150.00	500	\$75,000.00
16	Topsoil and Hydroseed	m2	\$12.00	1500	\$18,000.00
17	Traffic Signal Installation (Complete)	LS	\$200,000.00	1.0	\$200,000.00
18	Pavement Markings and Signage	lumpsum	\$15,000.00	1	\$15,000.00
19	Utility Pole Relocations Allowance	lumpsum	\$5,000.00	1	\$5,000.00
				SUBTOTAL	\$614,930.00
				Contingency (20% of subtotal)	\$122,990.00
TOTAL(excluding engineering and tax)					\$737,900.00

Town of Gander
 1901214 - Cooper Boulevard Transportation Study
 Cooper Blvd-Airport Blvd - Signalized Intersection Upgrade
 Class D Cost Estimate - May 12, 2020

Item No.	Description	Unit	Unit Price	Estimated Quantity	Total Cost
Removals					
1	Common Excavation	LS	\$5,000.00	1	\$5,000.00
2	Curb and Gutter Removal	m	\$15.00	0	\$0.00
3	Sidewalk Removal	m2	\$20.00	0	\$0.00
4	Saw Cut Asphalt	m	\$10.00	1000	\$10,000.00
5	Asphalt Removal	m2	\$10.00	900	\$9,000.00
6	Asphalt Cold Milling - 50mm depth	m2	\$10.00	7500	\$75,000.00
Roadway Construction					
7	New Concrete Curb and Gutter	m	\$120.00	390	\$46,800.00
8	Storm Sewer	LS	\$25,000.00	1	\$25,000.00
9	New Concrete Sidewalk	m2	\$120.00	430	\$51,600.00
10	New Concrete Island	m2	\$120.00	120	\$14,400.00
11	Rock Borrow (100mm Minus Rock Fill)	t	\$15.00	2600	\$39,000.00
12	Aggregate Sub-Base (Granular B 150mm)	t	\$22.00	760	\$16,720.00
13	Aggregate Base (Granular A 100mm)	t	\$25.00	510	\$12,750.00
14	Asphaltic Concrete Base (60mm Thickness)	t	\$140.00	380	\$53,200.00
15	Asphaltic Concrete Seal (40mm Thickness)	t	\$150.00	920	\$138,000.00
16	Topsoil and Hydroseed	m2	\$12.00	2000	\$24,000.00
17	Traffic Signal Installation (Complete)	LS	\$200,000.00	1.0	\$200,000.00
18	Pavement Markings and Signage	lumpsum	\$15,000.00	1	\$15,000.00
19	Utility Pole Relocations Allowance	lumpsum	\$5,000.00	1	\$5,000.00
				SUBTOTAL	\$740,470.00
				Contingency (20% of subtotal)	\$148,090.00
TOTAL(excluding engineering and tax)					\$888,600.00

Town of Gander
 1901214 - Cooper Boulevard Transportation Study
 Cooper Blvd-TCH - Extension of Right Turn Lane
 Class D Cost Estimate - May 12, 2020

Item No.	Description	Unit	Unit Price	Estimated Quantity	Total Cost
Removals					
1	Common Excavation	LS	\$10.00	2500	\$25,000.00
2	Curb and Gutter Removal	m	\$15.00	0	\$0.00
3	Sidewalk Removal	m2	\$20.00	0	\$0.00
4	Saw Cut Asphalt	m	\$10.00	260	\$2,600.00
5	Asphalt Removal	m2	\$10.00	125	\$1,250.00
6	Asphalt Cold Milling - 50mm depth	m2	\$10.00	200	\$2,000.00
Roadway Construction					
7	New Concrete Curb and Gutter	m	\$120.00	0	\$0.00
8	Storm Sewer	LS	\$10,000.00	0	\$0.00
9	New Concrete Sidewalk	m2	\$120.00	0	\$0.00
10	New Concrete Island	m2	\$120.00	0	\$0.00
11	Rock Borrow (100mm Minus Rock Fill)	t	\$15.00	1800	\$27,000.00
12	Aggregate Sub-Base (Granular B 150mm)	t	\$22.00	600	\$13,200.00
13	Aggregate Base (Granular A 100mm)	t	\$25.00	400	\$10,000.00
14	Asphaltic Concrete Base (60mm Thickness)	t	\$140.00	210	\$29,400.00
15	Asphaltic Concrete Seal (40mm Thickness)	t	\$150.00	250	\$37,500.00
16	Topsoil and Hydroseed	m2	\$12.00	1000	\$12,000.00
17	Traffic Signal Installation (Complete)	LS	\$200,000.00	0.0	\$0.00
18	Pavement Markings and Signage	lumpsum	\$10,000.00	1	\$10,000.00
19	Utility Pole Relocations Allowance	lumpsum	\$5,000.00	1	\$5,000.00
				SUBTOTAL	\$174,950.00
				Contingency (20% of subtotal)	\$34,990.00
TOTAL(excluding engineering and tax)					\$209,900.00

Town of Gander
 1901214 - Cooper Boulevard Transportation Study
 Multi-Use AT Pathway (2150m Long)
 Class D Cost Estimate - May 12, 2020

Item No.	Description	Unit	Unit Price	Estimated Quantity	Total Cost
Removals					
1	Common Excavation	LS	\$10.00	2600	\$26,000.00
2	Curb and Gutter Removal	m	\$15.00	0	\$0.00
3	Sidewalk Removal	m2	\$20.00	0	\$0.00
4	Saw Cut Asphalt	m	\$10.00	0	\$0.00
5	Asphalt Removal	m2	\$10.00	0	\$0.00
6	Asphalt Cold Milling - 50mm depth	m2	\$10.00	0	\$0.00
Roadway Construction					
7	New Concrete Curb and Gutter	m	\$120.00	0	\$0.00
8	Storm Sewer	LS	\$10,000.00	0	\$0.00
9	New Concrete Sidewalk	m2	\$120.00	0	\$0.00
10	New Concrete Island	m2	\$120.00	0	\$0.00
11	Rock Borrow (100mm Minus Rock Fill)	t	\$15.00	0	\$0.00
12	Aggregate Sub-Base (Granular B 150mm)	t	\$22.00	1300	\$28,600.00
13	Aggregate Base (Granular A 100mm)	t	\$25.00	900	\$22,500.00
14	Asphaltic Concrete Base (50mm Thickness)	t	\$140.00	0	\$0.00
15	Asphaltic Concrete Seal (50mm Thickness)	t	\$150.00	1420	\$213,000.00
16	Topsoil and Hydroseed	m2	\$12.00	4300	\$51,600.00
17	Traffic Signal Installation (Complete)	LS	\$200,000.00	0.0	\$0.00
18	Pavement Markings and Signage	lumpsum	\$15,000.00	1	\$15,000.00
19	Utility Pole Relocations Allowance	lumpsum	\$15,000.00	0	\$0.00
				SUBTOTAL	\$356,700.00
				Contingency (20% of subtotal)	\$71,340.00
TOTAL(excluding engineering and tax)					\$428,000.00